

7813

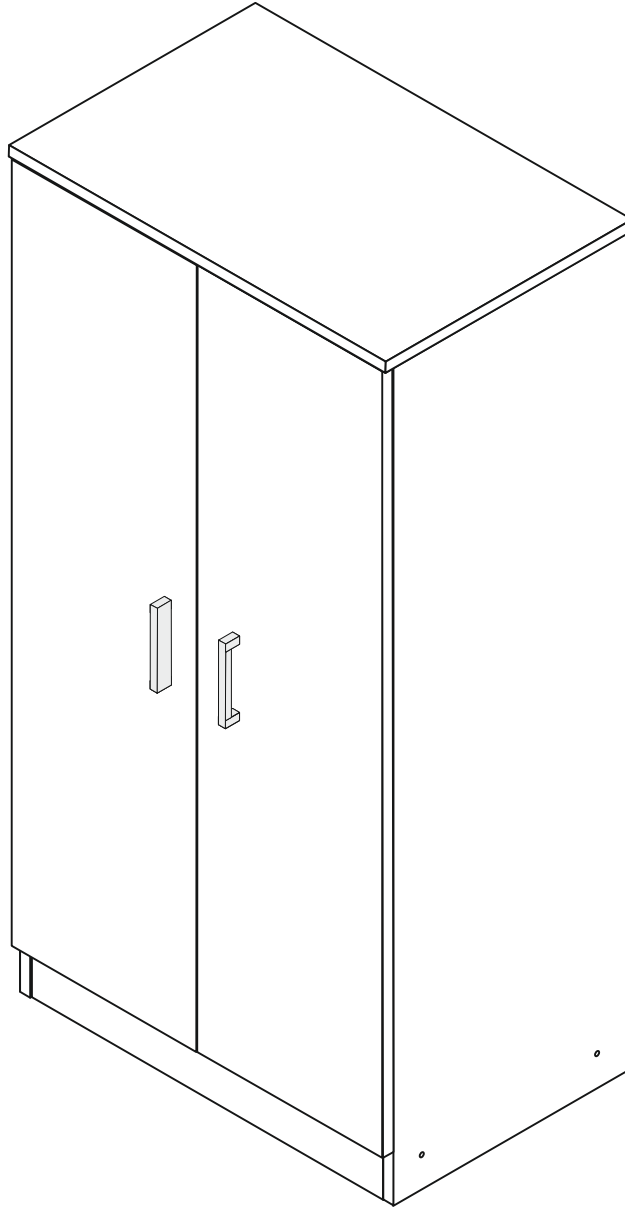

**ZAPATERO 2 PUERTAS - SHOE'S CABINET 2 DOORS -
ARMOIRE À CHAUSSURES 2 PORTES - SAPATEIRA 2 PORTAS -
SCARPIERA 2 ANTE - SCHUHSCHRANK - ΠΑΠΟΥΤΣΟΘΗΚΗ**

**INSTRUCCIONES DE MONTAJE - ASSEMBLING INSTRUCTIONS - NOTICE DE MONTAGE - INSTRUÇÕES DE MONTAGEM -
ISTRUZIONI DI MONTAGGIO - MONTAGEANLEITUNG - ΟΔΗΓΙΕΣ ΣΥΝΑΡΜΟΛΟΓΗΣΗΣ**

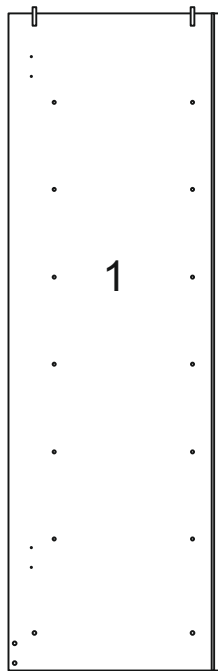
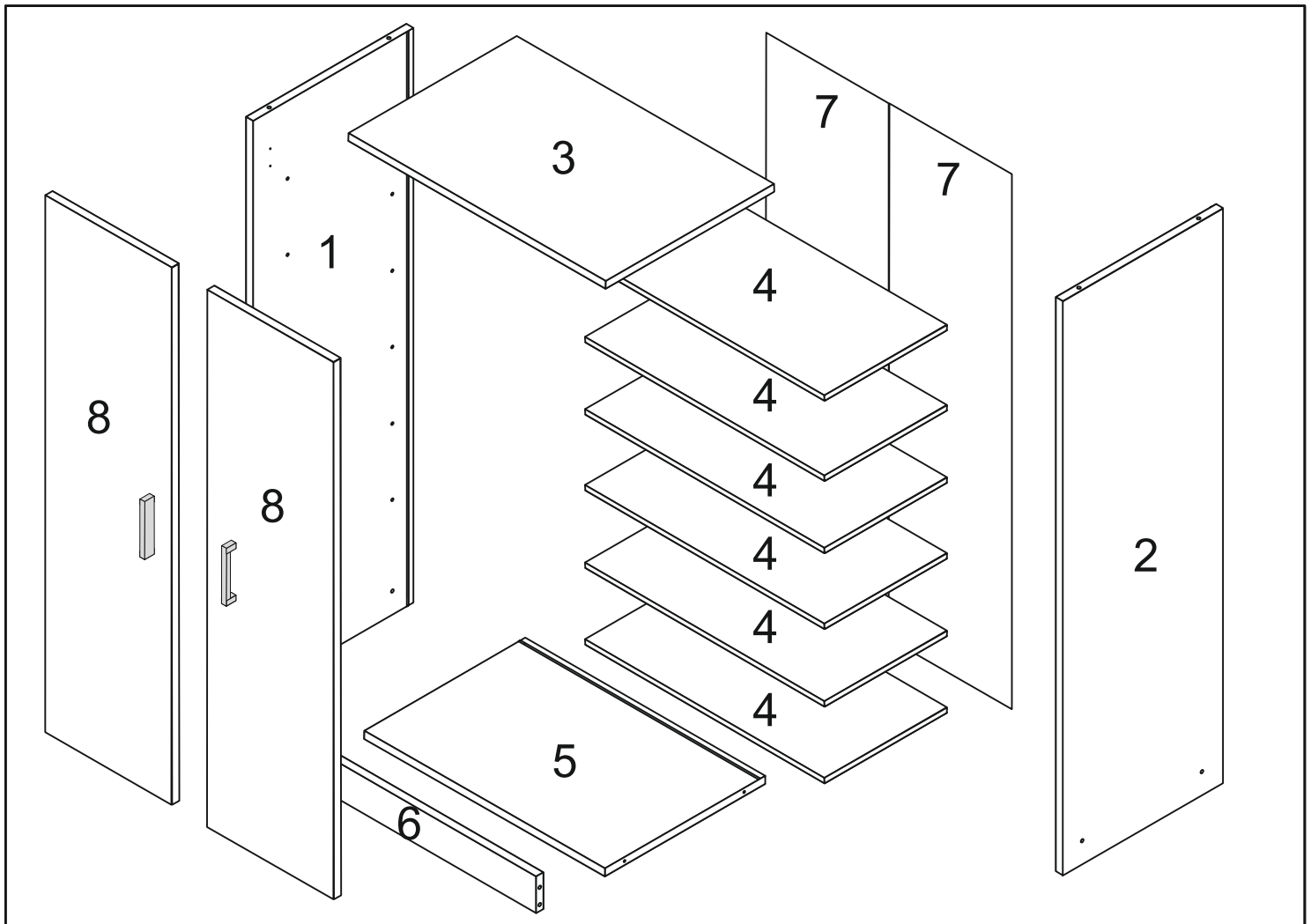

1064 x 343 mm

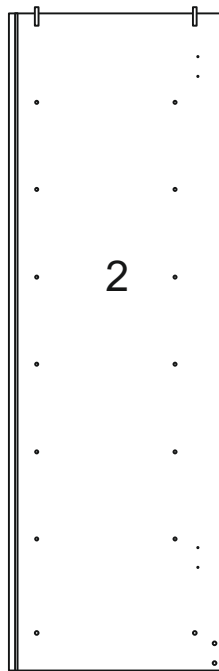

1064 x 343 mm

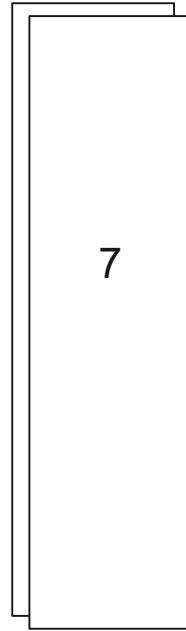

992 x 262 mm

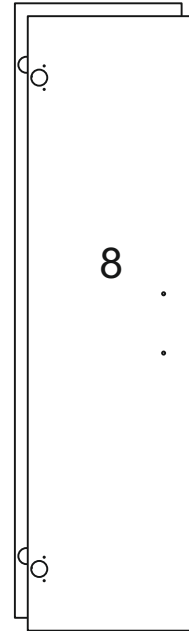

995 x 270 mm

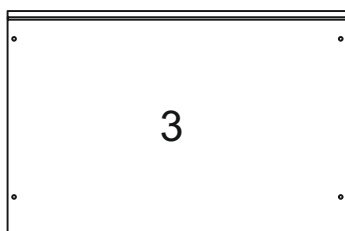

550 x 360 mm



514 x 343 mm

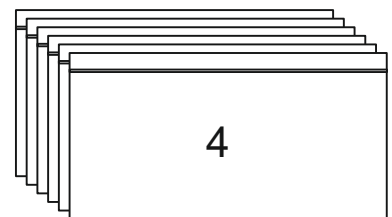

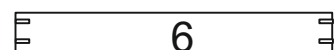

514 x 269 mm

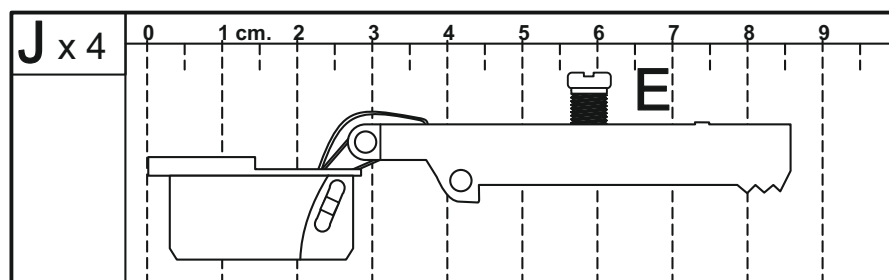
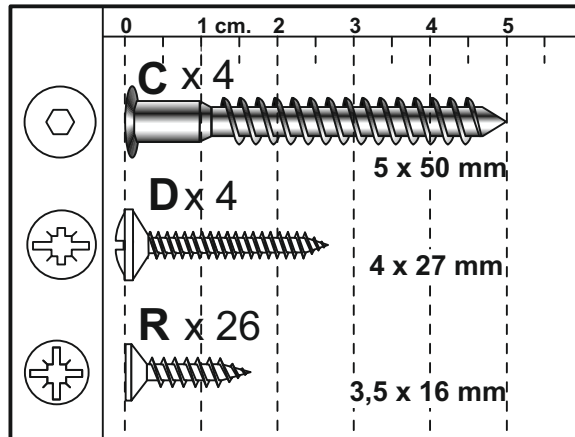
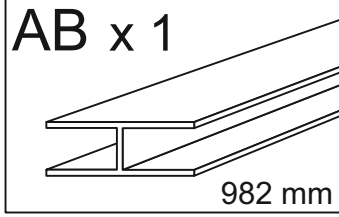
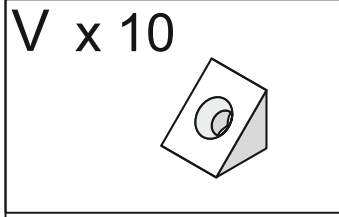
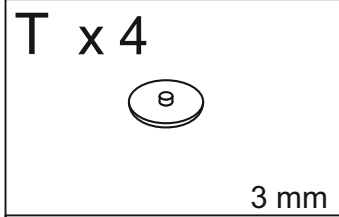
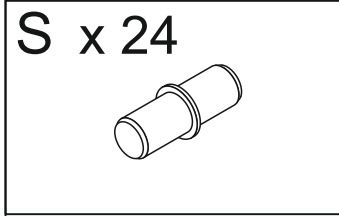
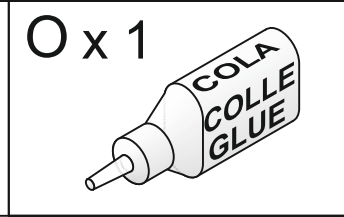
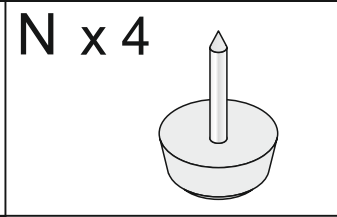
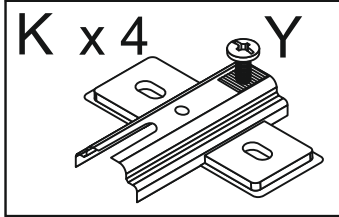
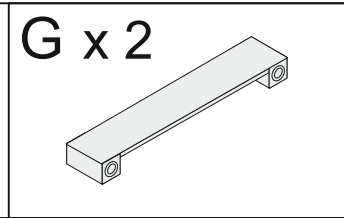
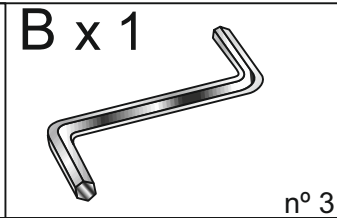
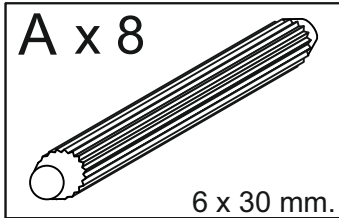
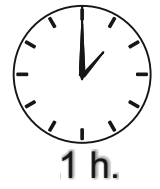
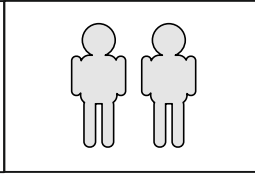
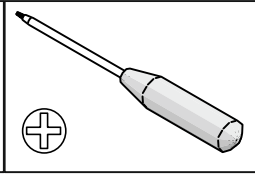
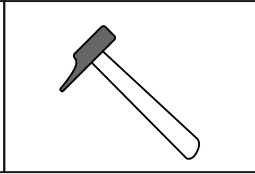
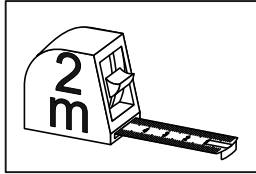

514 x 68 mm

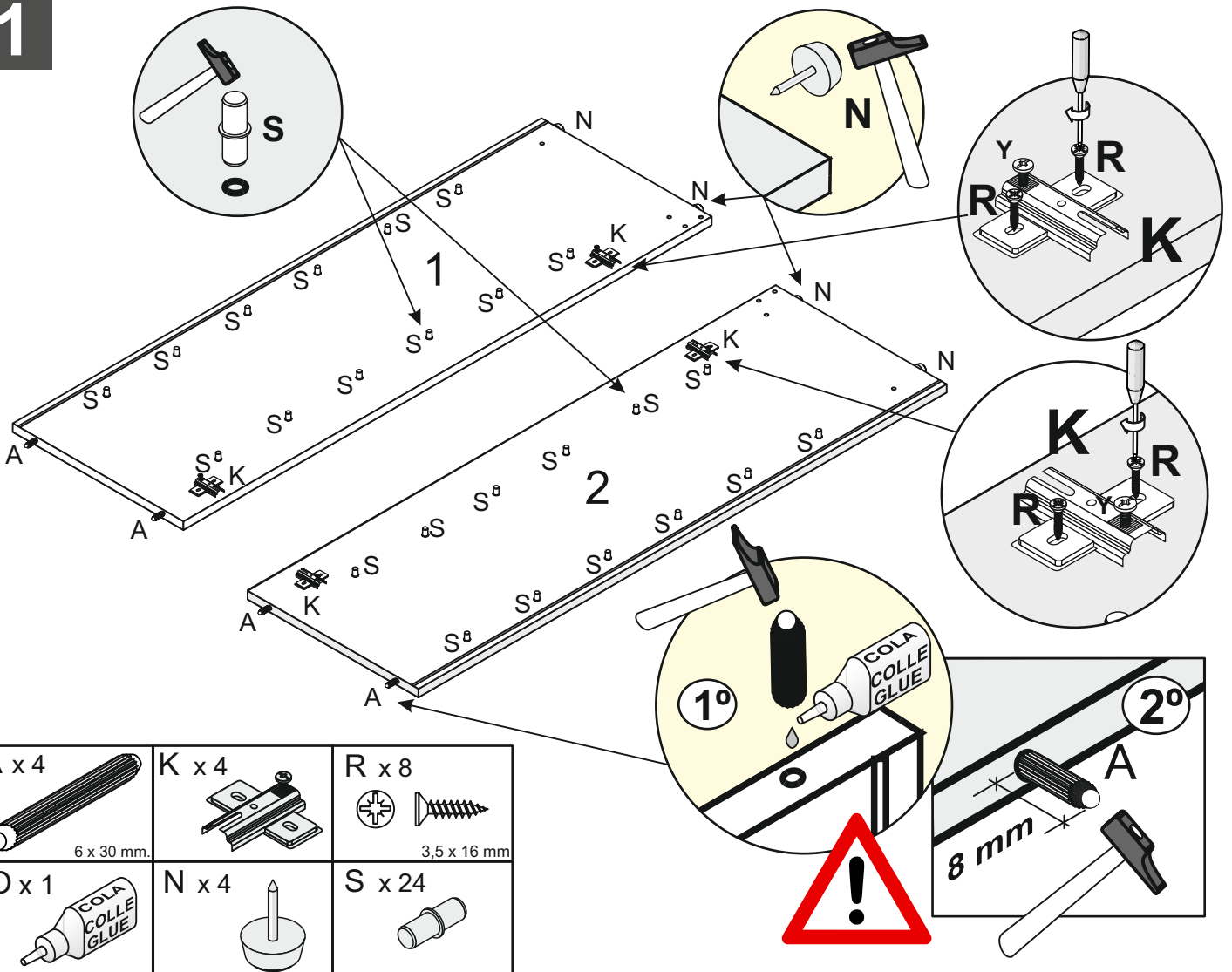

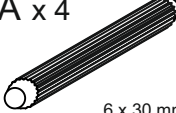
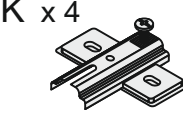
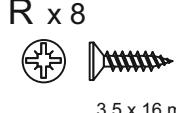
1

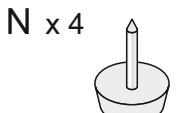
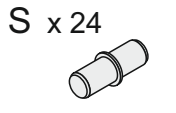
| | | |
|--|---|---|
| A x 4  6 x 30 mm. | K x 4  | R x 8  3,5 x 16 mm |
| O x 1  COLLA COLLE GLUE | N x 4  | S x 24  |

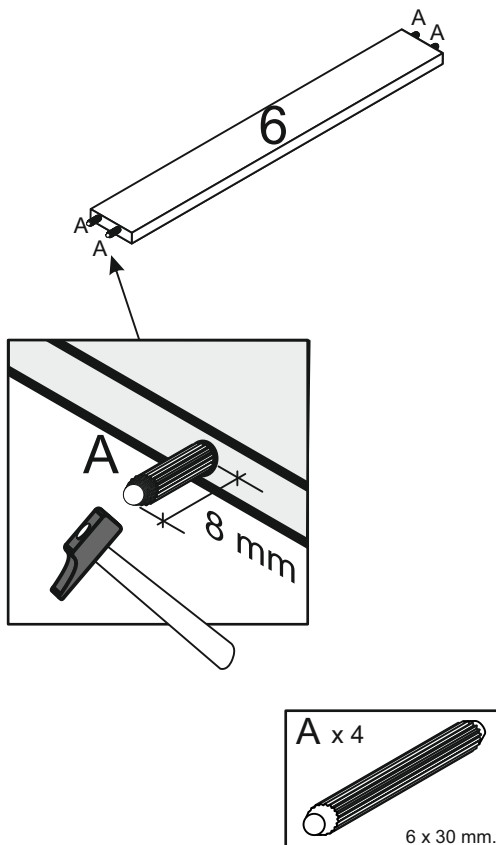
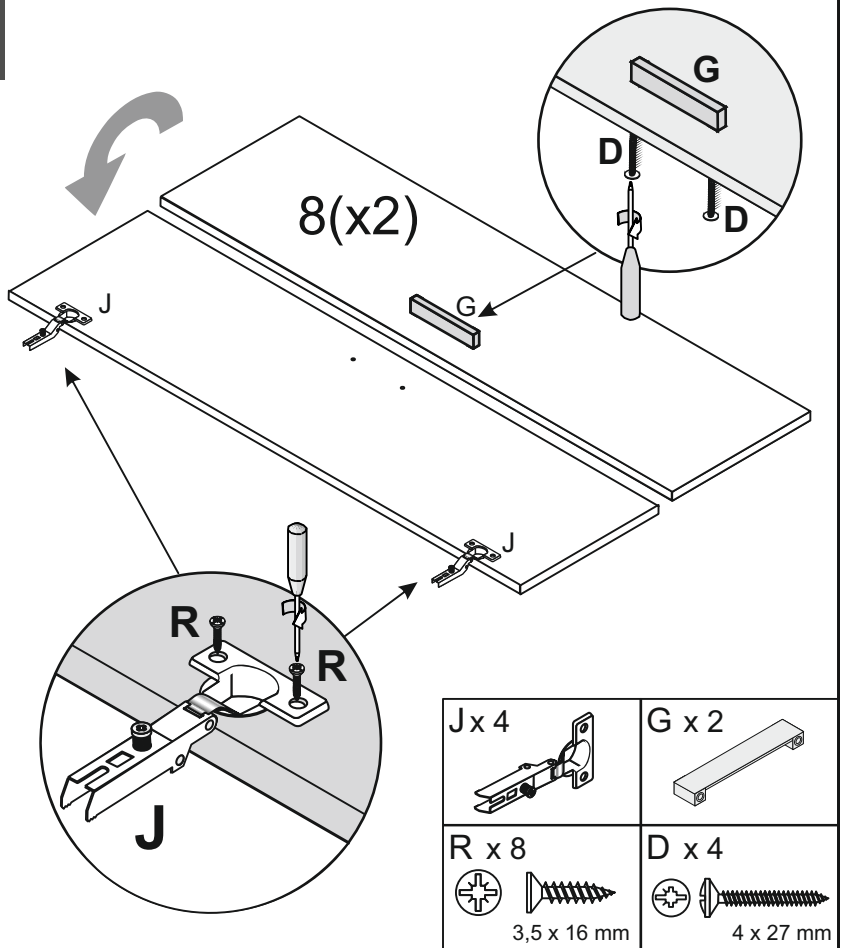
2**3**

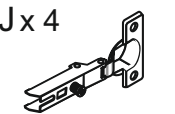
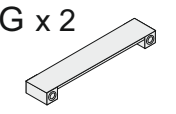
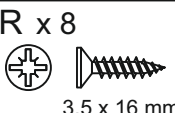
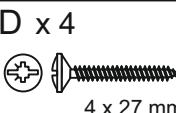
| | |
|--|--|
| J x 4  | G x 2  |
| R x 8  3,5 x 16 mm | D x 4  4 x 27 mm |

4

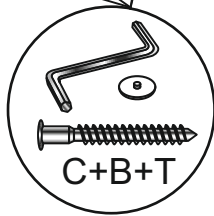
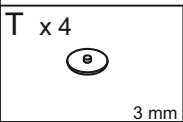
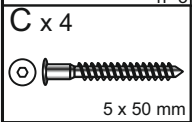
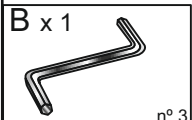
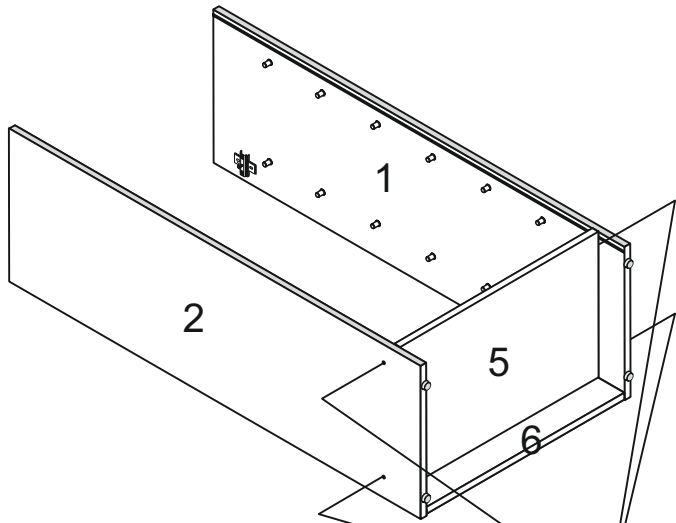

5

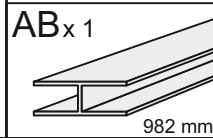
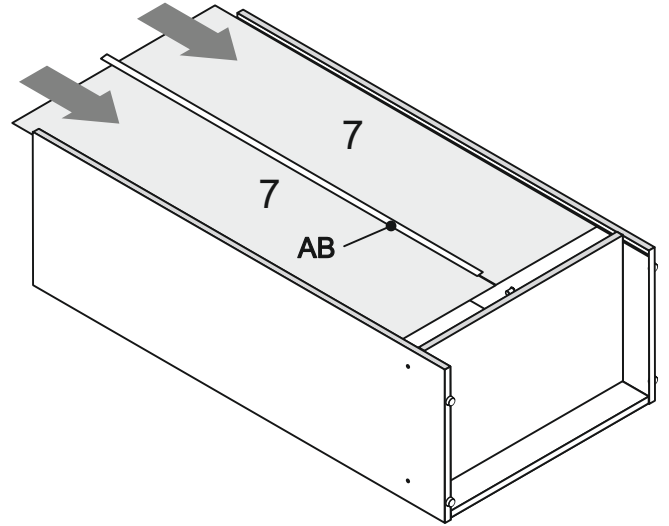

6

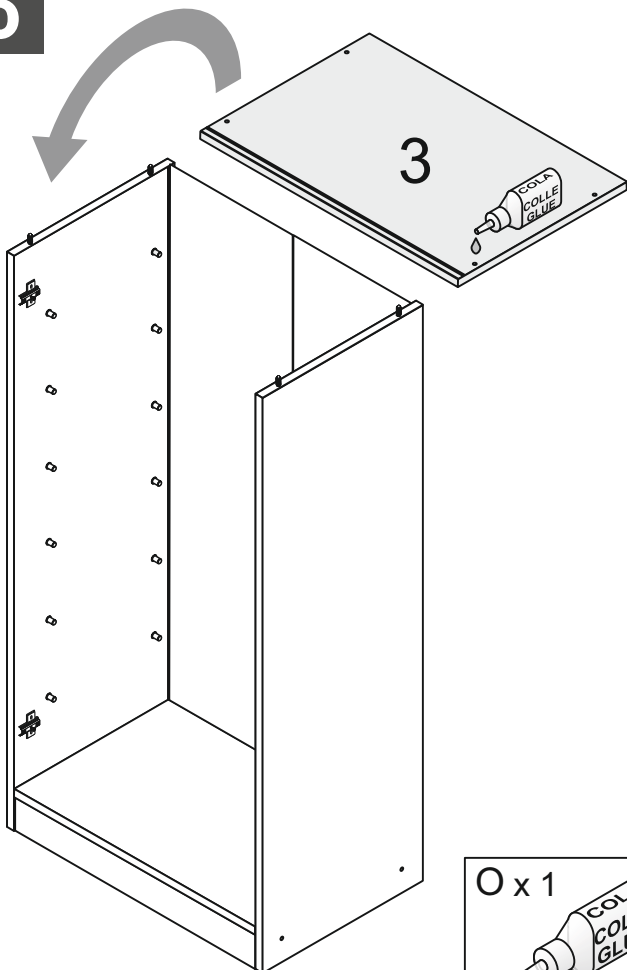

7

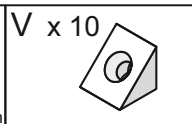
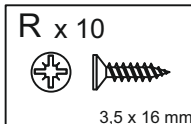
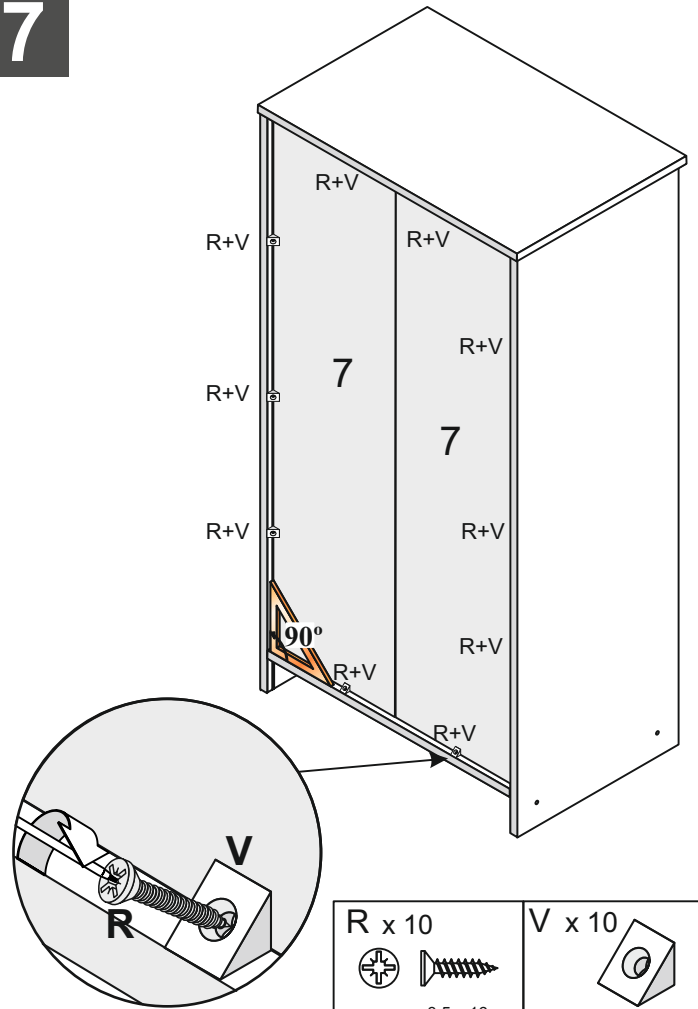

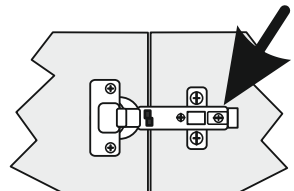
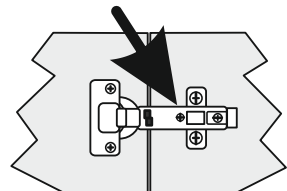
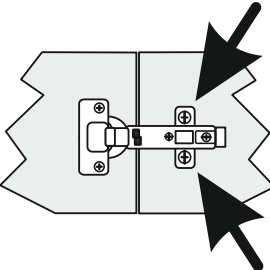
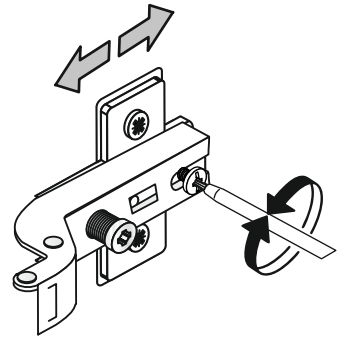
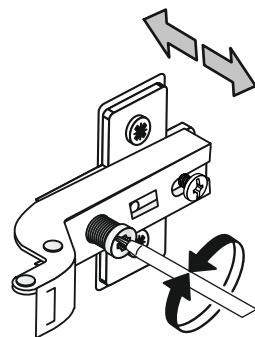
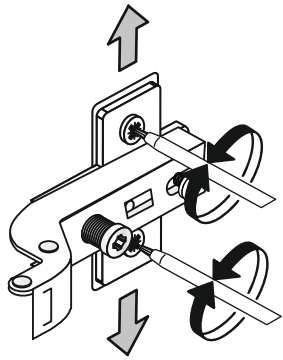
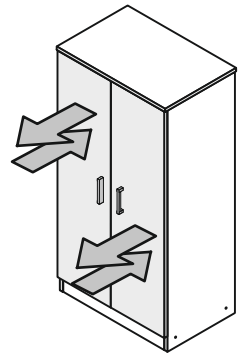
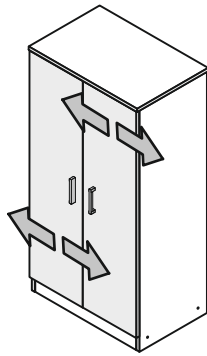
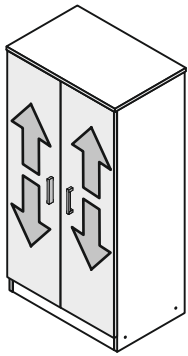
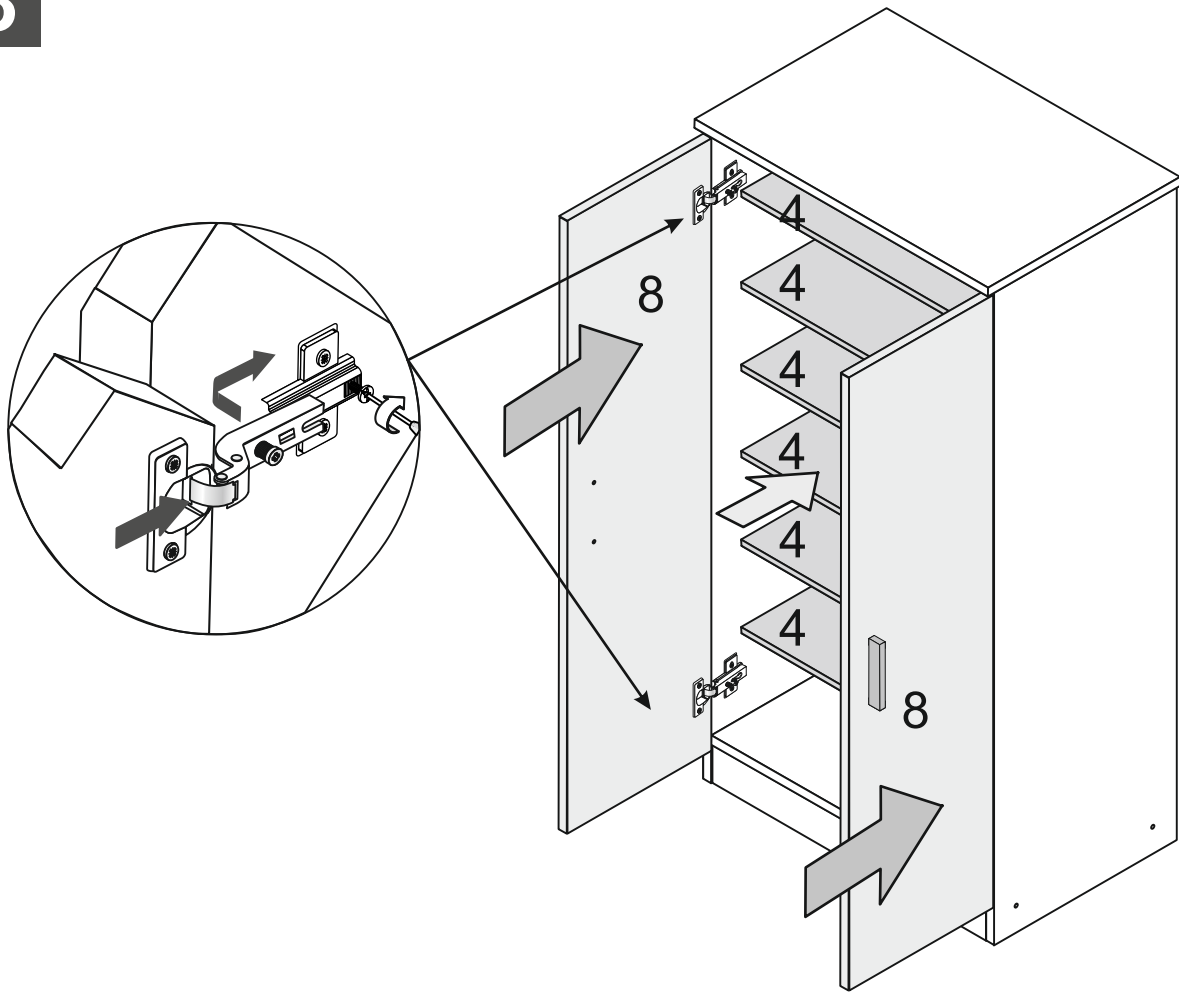

ES

MONTAJE

- Preparar las piezas que constituyen el mueble.
- Reagrupar y contar el herraje.
- Preparar las herramientas necesarias.
- Prepara la zona de montaje.
- Realizar el montaje sobre una moqueta para evitar rayar el mueble.
- No forzar nunca los ensamblajes.

USO

- No colocar cerca de fuentes de calor.
- Mueble apto para uso doméstico. Ubicación en el interior de la vivienda.
- Se recomienda, tras la instalación del mueble, airear la habitación donde se encuentre durante varias semanas.

MANTENIMIENTO Y LIMPIEZA

- Limpiar con un paño humedecido con una solución jabonosa.
- Secar con un paño limpio.
- No utilizar paños, trapos o productos de limpieza que puedan rayar la superficie del mueble

IT

INSTALLAZIONE

- Prerapare i pezzi che costituiscono il mobile.
- Raggruppare e contare la ferramenta.
- Preparare gli attrezzi necessari.
- Preparare una zona per il montaggio.
- Realizzare il montaggio sopra un tappeto per evitare che il mobile si graffi.
- Non forzare mai l'assemblaggio.

USO

- Non collocare vicino a fonti di calore.
- Mobile adatto ad un uso domestico. Adatto a uso interno.
- Dopo l'installazione del mobile, si consiglia di arieggiare la stanza per varie settimane.

ISTRUZIONI PER LA PULIZIA

- Pulire con un panno umido e un detergente neutro.
- Asciugare con un panno pulito.
- Non utilizzare panni, trappi o prodotti di pulizia che possano graffiare la superficie del mobile.

EN

ASSEMBLE

- Prepare the different pieces of the furniture.
- Regroup and count the hardware.
- Prepare the necessary tools.
- Prepare the area to assemble to furniture.
- Assemble the furniture on a carpet to avoid any damages.
- Do not force the hardware.

USE

- Do not place the furniture near the heat sources.
- It's suitable for domestic use, keep it indoors.
- It is recommended, after the assembling to air the room for several weeks.

MAINTENANCE AND CLEANING

- Clean it with a damp cloth with mild cleaners.
- Dry it with a clean cloth.
- Do not use cloths or cleaning products that could damage the surface of the furniture.

DE

MONTAGEHINWEISE

- Sortieren und identifizieren Sie die Einzelteile.
- Überprüfen Sie die Anzahl der einzelnen Beschlagteile.
- Legen Sie das notwendige Werkzeug bereit.
- Machen Sie einen Montagebereich frei.
- Montieren Sie das Möbelstück auf einem ebenen, weichen und sauberen Untergrund.
- Überziehen Sie die Beschlagteile nicht.

GEBRAUCHSHINWEISE

- Platzieren Sie das Möbelstück niemals neben Wärmequellen.
- Das Möbelstück ist ausschließlich für den Gebrauch im Haus geeignet.
- Es wird empfohlen, nach dem Aufbau des Möbelstücks, den Raum in dem es sich befindet, mehrere Wochen lang zu lüften.

REINIGUNG UND PFLEGE

- Mit einem feuchten Tuch mit milder Seifenlösung abwischen.
- Trocken nachwischen.
- Für die Reinigung verwenden Sie bitte ein weiches Tuch und keinesfalls scharfe oder ätzende Reinigungsmittel.

FR

MONTAGE

- Identifier les différents panneaux.
- Regrouper et compter la quincaillerie.
- Munissez-vous de l'outillage nécessaire.
- Amenagez-vous une zone de montage. La moquette ou une couverture protégera des rayures.
- Ne jamais forcer le montage.

USAGE

- Ne pas placer près des sources de chaleur.
- Meuble apte pour l'usage domestique, on peut le placer à l'intérieur de la maison.
- Il est recommandé, après l'installation du meuble dans son logement, d'aérer fréquemment la pièce concernée pendant quelques semaines.

ENTRETIEN ET NETTOYAGE

- Nettoyer avec un chiffon humide et une solution savonneuse.
- Essuyer avec un chiffon sec et propre.
- N'utiliser pas de chiffons ou des produits de nettoyage qui puissent rayer la superficie du meuble.

PT

MONTAGEM

- Prepare as peças que compõem o móvel.
- Reagrupe e contar as ferragens.
- Prepare as ferramentas necessárias.
- Prepara a área para a montagem.
- Efectuar a montagem sobre uma alcatifa para evitar arranhar o móvel.
- Nao forar nunca a ensambladura.

USO

- Nao colocar perto de fontes de calor.
- Móvel apto para o uso doméstico. Colocação no interior da vivenda.
- Após a instalação dos móveis, é recomendável ventilar por várias semanas a sala onde está localizado.

MANUTENÇÃO E LIMPEZA

- Limpe bem com um pano humedecido numa solução detergente suave.
- Seque bem com um pano limpo.
- Nao utilizar panos, trapos ou produtos de limpeza que possam riscar a superficie do móvel.

GR

ΣΥΝΑΡΜΟΛΟΓΗΣΗ

- Προετοιμάστε τα μέρη του επίπλου.
- Ομαδοποιήστε και μετρήστε τα μικρά μέρη (βίδες, μεντεσέδες...).
- Προετοιμάστε τα εργαλεία που θα χρειαστείτε.
- Προετοιμάστε το χώρο συναρμολόγησης.
- Μια μοκέτα θα προφύλασσε από γρατζουνιές.
- Μη ασκείτε πίεση στην εφαρμογή.

ΧΡΗΣΗΣ

- Μη τοποθετείτε κοντά σε πηγή θερμότητας.
- Το έπιπλο έχει κατασκευαστεί για οικιακή χρήση, τοποθετήστε το στο εσωτερικό της οικίας.
- Συνιστάται, μετά την εγκατάσταση του επίπλου, ο χώρος να αερίζεται για αρκετές εβδομάδες, ές ουσίως.

ΣΥΝΤΗΡΗΣΗ ΚΑΙ ΚΑΘΑΡΙΣΜΟΣ

- Καθαρίστε το με ένα πανί μουσκεμένο σε ένα ελαφρύ απορρυπαντικό.
- Στεγνώστε το με ένα καθαρό πανί.
- Μη χρησιμοποιείτε πανιά και καθαριστικά που μπορούν να καταστρέψουν την επιφάνεια.

GARANTÍA - GUARANTEE - GARANTIE - GARANTIA - GARANZIA - GARANTIE - GARANTISI

ES Fabricado en U.E. por FORES DISEÑO S.L. C.I.F: B-12313003 - Ctra.Nac.232; Km 11,1 C.P. 12320 - Sant Jordi (Castellón) SPAIN - el cual garantiza este producto por un periodo de **2 años** a partir de la fecha de compra, contra todo defecto de fabricación.

Si se encuentra alguna dificultad a la hora del montaje o existe algún defecto en el mueble, puede contactar con nosotros al **964 46 52 22** o por e-mail: **postventa@fores.es** donde gustosamente atenderemos todas sus consultas. HORARIO: de lunes a viernes de 9h a 14h y de 15h a 18h.

Esta garantía no ampara los defectos producidos por un mal montaje, utilización indebida o mal uso del mueble.

Es imprescindible conservar el **ticket** de compra y facilitar el **Nº de Control de Calidad (Q.C.)** para cualquier consulta o reclamación.

EN Manufactured in Spain by FORES DISEÑO S.L. CIF B-12313003-ctra Nac 232 km 11.1 C.P.12320-Sant Jordi, (Castellón) SPAIN - Guarantee of **2 years** from date of purchase against any fault of production.

If a difficulty when assembly or a fault in the product is found you can contact us at **(+34) 964 46 52 22** or by email: **postventa@fores.es** where we will be pleased to help you. TIMETABLE: Monday until Friday 9-14h / 15-18h.

The Guarantee does not cover the faults produced by an incorrect assembly or misuse of the furniture.

Indispensable to keep the purchase **ticket** and facilitate the **Nº of Quality Control (Q.C.)** for any consult or claim.

FR Fabriqué en UE par FORES DISEÑO S.L. CIF B-12313003 - Ctra Nac 232; Km 11,1 CP12320 - Sant Jordi (Castellón) Espagne - Celui ci garantie ce produit pour une période de **2 ans** à partir de la date d'achat, contre tout défaut de fabrication.

Si vous rencontrez une quelconque difficulté à l'heure du montage ou si il y a un défaut sur le meuble, vous pouvez nous contacter par téléphone au **(+34) 964 46 52 22** ou bien par e-mail à **postventa@fores.es** où nous aurons le plaisir de vous accueillir pour toutes demandes. Nos HORAIRES sont du lundi au vendredi de 9H00 à 14H00 et de 15H00 à 18H00.

Cette garantie ne couvre pas les défauts résultants d'un mauvais montage, d'une utilisation indue ou d'un mauvais usage du produit.

Il est indispensable de garder le **ticket** ou facture d'achat et de communiquer **le Numéro de Control Qualité (Q.C.)** pour une quelconque demande ou réclamation.

PT Fabricado U.E. por FORES DISEÑO S.L. C.I.F: B-12313003 - Ctra.Nac.232; 11,1 km C.P. 12320 - Sant Jordi (Castellón) ESPANHA - que garante este produto por um período de **2 anos** a partir da data de compra; contra defeitos de fabricação.

Se você encontrar qualquer dificuldade na montagem ou se houver qualquer defeito no armário, você pode contactar-nos pelos seguintes meios: **(+34) 964 46 52 22** ou por e-mail: **postventa@fores.es** onde será recebido de bom grado para atenderder-mos todas as suas dúvidas. HORÁRIOS: Segunda a sexta-feira das 9h às 14h e 15h às 18h.

Esta garantia não cobre defeitos causados pela montagem incorreta, uso indevido ou mau trato do produto.

É essencial manter o **recibo** de compra e facilitar o **Nº Controle de Qualidade (Q.C.)** para quaisquer dúvidas ou reclamações.

IT Prodotto in Spagna da: FORES DISEÑO S.L. CIF B-12313003-ctra Nac 232 km 11.1 C.P.12320-Sant Jordi, (Castellón) SPAIN. Garantito **2 Anni** dalla data di acquisto contro ogni difetto di produzione.

In caso di difficoltà nel montaggio o di mancanza di componenti potete chiamare il **(+34) 964 46 52 22** o inviare email a: **postventa@fores.es** Il servizio è attivo dal Lunedì al Venerdì ore 9:00-14:00 / 15:00-18:00 Saremo lieti di aiutarvi.

La garanzia non copre difetti o danni dovuti a montaggio scorretto o ad uso improprio del prodotto.

La garanzia é valida solo in presenza dello **scontrino di acquisto** e del **Nº di controllo qualità (Q.C.)** presente nella confezione

DE Hergestellt in Spanien von FORES DISEÑO S.L. CIF B-12313003-ctra Nac 232 km 11.1 CP12320-Sant Jordi (Castellón) SPANIEN - Garantie von **2 Jahren** ab kaufdatum gegen jede störung der produktion.

Wenn Sie irgendwelche schwierigkeiten bei der montage zu finden oder es irgendeinen defekt in dem schrank, können sie uns unter **(+34) 964 46 52 22** oder per email an: **postventa@fores.es**, wo wir gerne besuchen, um alle Ihre Fragen. ÖFFNUNGSZEITEN: Montag bis Freitag von 9h bis 14h und 15h bis 18h.

Diese Garantie gilt nicht für Mängel, die durch unsachgemäße Installation, unsachgemäße Behandlung und Verwendung des Geräts verursacht werden.

Unentbehrlich, um den **Kauf Ticket** behalten und erleichtern die Anzahl der **Qualitätskontrollzahl (Q.C.)** für alle zu konsultieren oder Anspruch.

GR Κατασκευάζεται στην Ισπανία από CIF B-12313003-Ctra Nac 232 χλμ 11.1 CP12320-Sant Jordi, στην Ισπανία - Η εγγύηση ισχύει για **2 έτη** από την αρχική ημερομηνία αγοράς και καλύπτει ελαττωματικά υλικά ή ελαττωματική κατασκευή του προϊόντος.

Σε περίπτωση δυσκολίας σας κατά την συναρμολόγηση ή πιθανής βλάβης στο προϊόν, μπορείτε να επικοινωνήσετε μαζί μας στο **(+34) 964 46 52 22** ή μέσω email: **postventa@fores.es** Θα χαρούμε να σας βοηθήσουμε. ΗΜΕΡΕΣ & ΩΡΕΣ ΕΞΥΠΗΡΕΤΗΣΗΣ: Δευτέρα έως Παρασκευή 9:00-14:00 & 15:00-18:00.

Η εγγύηση δεν καλύπτει τις βλάβες που προέρχονται από λάθη στην συναρμολόγηση ή την μη ορθολογική χρήση των επίπλων.

Είναι απαραίτητο να κρατήσετε την **απόδειξη αγοράς** του προϊόντος και τον **αριθμό ποιοτικού ελέγχου (Q.C.)**, ώστε να διευκολύνετε οποιαδήποτε διαδικασία αίτησης ή συμβουλής χρειαστείτε.

Nº de Control de Calidad (Q.C.):
Nº of Quality Control (Q.C.):
Nº de Contrôle Qualité (Q.C.):
Nº de Controle de Qualidade (Q.C.):
Nº di Controllo qualità (Q.C.):
Qualitätskontrollzahl (Q.C.):
Ποιοτικός έλεγχος Αριθμός (Q.C.):



GUARDE ESTE NÚMERO
SAVE THIS NUMBER
SAUVEZ CE NUMÉRO
GUARDE ESTE NÚMERO
CONSERVA QUESTO NUMERO
SPEICHERN SIE DIESE NUMMER
ΦΥΛΑΞΤΕ ΑΥΤΟ ΤΟ ΑΡΙΘΜΟ

Q.C.

