

Manual de instrucciones
Instructions & installation manual
Manuel d'installation et utilisation
Manual de instalação e uso

RCES_LCD



Español

English

Français

Português

4	1. ADVERTENCIAS GENERALES
7	2. INSTALACIÓN
12	3. FUNCIONAMIENTO
12	3.1 PANEL DE CONTROL
12	3.2 PANTALLA
13	3.3 INICIO - PRIMERA CONEXIÓN
14	3.4 MODOS DE FUNCIONAMIENTO
14	3.4.1 MODO AUTO (PROGRAMACIÓN)
15	3.4.2 MODO OFF
15	3.4.3 MODO ANTIHIELO
16	3.4.4 MODO MANUAL
17	3.5. MENÚ USUARIO
38	3.6 MENÚ AVANZADO
44	3.7 FUNCIÓN “BLOQUEO DE TECLADO”
44	3.8 MENSAJE ERROR “ERR”
44	4. MANTENIMIENTO

45	1. CAUTION
47	2. INSTRUCTIONS FOR INSTALLATION
52	3. OPERATION
52	3.1 CONTROL PANEL
52	3.2 SCREEN DESCRIPTION
53	3.3 START - FIRST CONNECTION
54	3.4 OPERATING MODES
54	3.4.1 AUTO MODE (PROGRAMMING)
55	3.4.2 OFF MODE
55	3.4.3 ANTI-FREEZE MODE
56	3.4.4 MANUAL MODE
57	3.5 USER MENU
78	3.6 ADVANCED MENU
84	3.7 “KEYBOARD LOCK” FUNCTION
84	3.8 ERROR MESSAGE “ERR”
84	4. MAINTENANCE

85	1. AVERTISSEMENTS GÉNÉRAUX
88	2. INSTRUCTIONS D'INSTALLATION
93	3. FONCTIONNEMENT
93	3.1 PANNEAU DE COMMANDE
93	3.2 AFFICHAGE
94	3.3 DÉMARRAGE - PREMIÈRE BRANCHEMENT
94	3.4 MODES DE FONCTIONNEMENT
95	3.4.1 MODE AUTO (PROGRAMMATION)
96	3.4.2 MODE OFF
96	3.4.3 MODE HORS-GEL
97	3.4.4 MODE MANUEL
98	3.5 MENU UTILISATEUR
119	3.6 MENU AVANCÉ
125	3.7 FONCTION "VERROUILLAGE CLAVIER"
125	3.8 MESSAGE D'ERREUR "ERR"
125	4. ENTRETIEN

126	1. ADVERTÊNCIAS GERAIS
128	2. INSTALAÇÃO
133	3. FUNCIONAMENTO
133	3.1 PAINEL DE CONTROLO
133	3.2 ECRÃ
134	3.3 INÍCIO - PRIMEIRA CONEXÃO
135	3.4 MODOS DE OPERAÇÃO
135	3.4.1 MODO AUTOMÁTICO (PROGRAMAÇÃO)
136	3.4.2 MODO DESLIGADO
136	3.4.3 MODO ANTI-GELO
137	3.4.4 MODO MANUAL
138	3.5 MENU DO USUÁRIO
159	3.6 MENU AVANÇADO
165	3.7 FUNÇÃO "BLOQUEO DE TECLADO"
165	3.8 MENSAGEM DE ERRO "ERR"
165	4. MANUTENÇÃO

- **Por favor, lea estas instrucciones detenidamente.**
- Para desconectar el emisor de la red eléctrica saque la clavija de alimentación del enchufe. **Nunca tire del cable.**
- No dejar el cable de conexión en contacto con el aparato mientras esté encendido.
- **La garantía del aparato no cubrirá cualquier daño causado por la no lectura de estas instrucciones.**



PELIGRO: NO CUBRIR EL APARATO. NO LO USE PARA SECAR ROPA. Si se cubre, existe el riesgo de producirse un sobrecalentamiento.



• **PELIGRO: Si el cable de alimentación está dañado, debe ser sustituido por el fabricante, por su Servicio Postventa o por personal cualificado similar.**



• **PELIGRO: Si el aparato se va a instalar en un cuarto de baño, debe ser instalado de tal manera que no pueda ser tocado por cualquier persona que se encuentre en la bañera o ducha.**



• **La instalación debe ser efectuada teniendo en cuenta estas instrucciones y acorde a la legislación eléctrica vigente.**

• El aparato no debe estar situado debajo o delante de una toma de corriente.

• La instalación debe ser efectuada según la legislación eléctrica vigente.

• Este aparato debe ser conectado a tierra.

• El emisor debe ser instalado de tal manera que la clavija de alimentación sea siempre accesible.

• **Este emisor térmico es un aparato para fijarlo a la pared. Este emisor no se debe encastrar. Respetar siempre las distancias de seguridad.**

• **Para evitar que los niños puedan variar la programación del emisor, dispone de un bloqueo.**

• Durante su funcionamiento, debe tenerse la precaución de

mantener el aparato alejado de materiales combustibles tales como cortinas, moquetas, muebles, etc.

- Este aparato no está pensado para ser usado por personas (incluidos niños) con capacidades físicas reducidas, sensoriales o mentales, con poca experiencia o conocimiento, al menos que estén bajo supervisión de una persona responsable de su seguridad con las instrucciones de uso del aparato. Los niños deben ser supervisados para asegurar que no juegan con el aparato.

- Los niños menores de 3 años deben mantenerse fuera del alcance del aparato a menos que sean continuamente supervisados. Los niños desde 3 años y menores de 8 años deben sólo encender/apagar el aparato siempre que éste haya sido colocado o instalado en su posición de funcionamiento normal prevista y que sean supervisados o hayan recibido instrucciones relativas al uso del aparato de una forma segura y entiendan los riesgos que el aparato tiene.

- Los niños desde 3 años y menores de 8 años no deben enchufar, regular y limpiar el aparato o realizar operaciones de mantenimiento.

- Este aparato puede ser usado por niños mayores de 8 años y por personas con discapacidades físicas, sensoriales o mentales, o sin experiencia o conocimientos, siempre y cuando hayan sido debidamente formados y sean supervisados por alguien que entienda los riesgos.

- La limpieza y el mantenimiento a realizar por el usuario no se deben hacer por niños. Los niños no deben jugar con el aparato.



- **PRECAUCIÓN: Algunas partes de este producto pueden ponerse muy calientes y causar quemaduras.** Debe ponerse atención particular cuando los niños y las personas vulnerables estén presentes.

- No tocar las partes externas del emisor cuando esté en funcionamiento.

- Antes del primer arranque o antes del comienzo de la campaña de invierno o cuando el emisor no se ha usado durante muchos días, el aparato debe ser limpiado (siga los pasos del punto “mantenimiento” de este manual).

- Es normal que en las primeras puestas en marcha, el aparato produzca olores. Ponga en marcha el aparato en un lugar ventilado durante 2 ó 3 horas.



- **PRECAUCIÓN:** Para evitar riesgos de asfixia, no dejar las bolsas y demás accesorios al alcance de bebés y niños.
- Este emisor **NO puede funcionar** con centralitas externas programables o cualquier otro dispositivo de control exterior.
- El efecto de la convección, junto a otros factores ambientales, puede causar **decoloración en las superficies metálicas y en los plásticos.**
- Los contrastes de temperatura pueden generar “chasquidos” o ruidos en el aparato. Esto no es un fallo del emisor, sino que se debe a la dilatación/contracción del aluminio.
- Cuando se desechen los emisores, deben tenerse en cuenta los requisitos establecidos por la legislación para el tratamiento y reciclaje de los residuos.



IMPORTANTE

- Es indispensable que el emisor **SE FIJE FIRMEMENTE A UNA PARED ESTABLE Y NIVELADA.**
- Comprobar que exista un enchufe cerca de donde lo vaya a situar.
- Saque del interior de la caja de embalaje la plantilla donde se indica la posición de los taladros para colocar el aparato a la pared.
- Para evitar problemas es necesaria una distancia mínima de 15 cm entre el emisor y cualquier material.

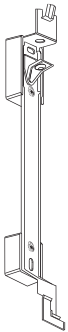
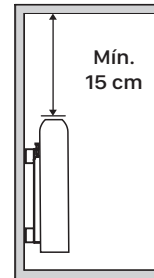
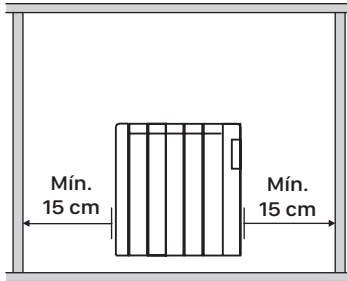

A

VERSIÓN

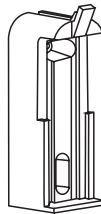

B

VERSIÓN

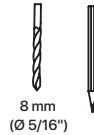
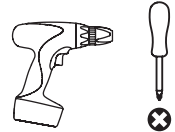

8 mm
(Ø 5/16")

* No incluido

A

VERSIÓN

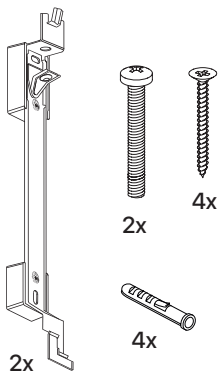

1.1

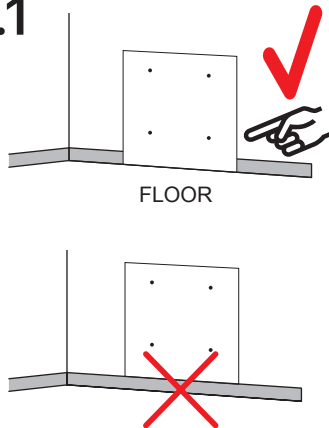

1.2

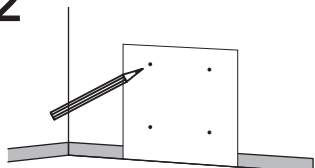

1.3

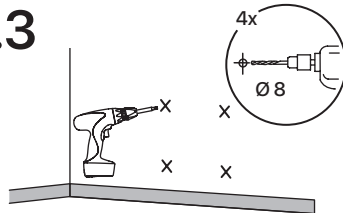

1.4

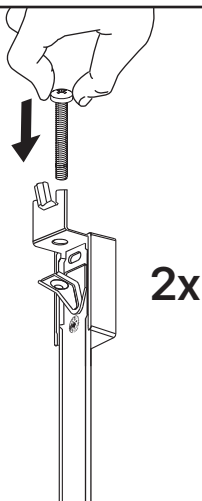

1.5

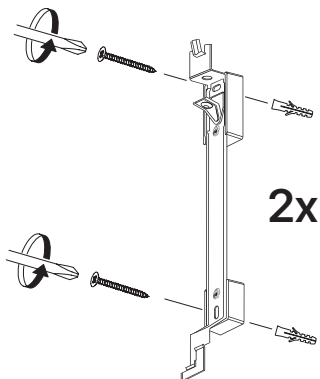

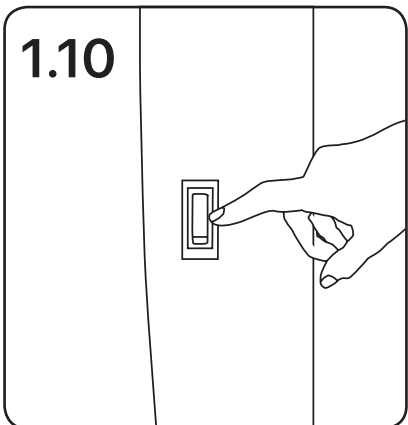
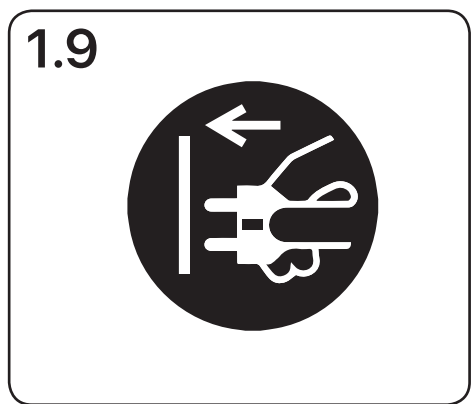
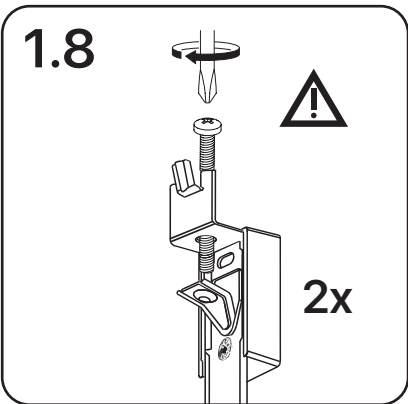
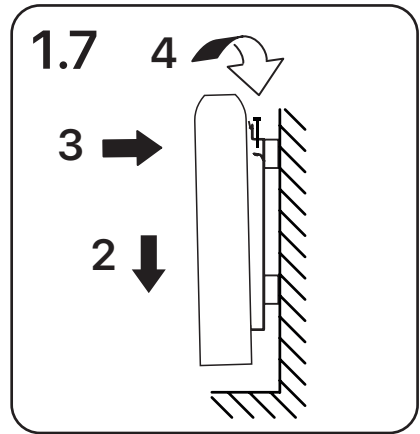
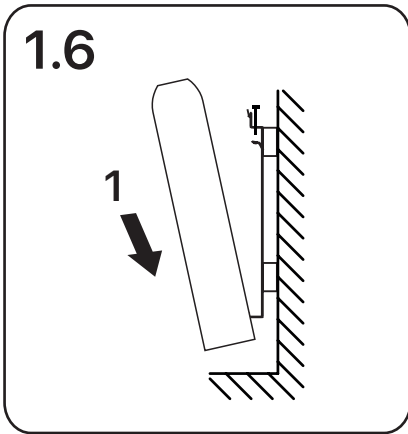

i

(W)	"A" (mm)	"B" (mm)	"C" (mm)
600	420	246	159
900	420	246	319
1200	420	246	478
1500	420	246	638
1800	420	246	638

B VERSIÓN

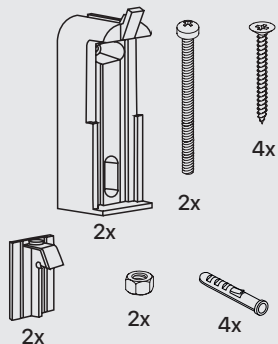

2.1

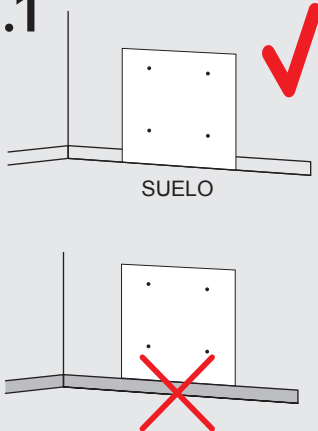

2.2

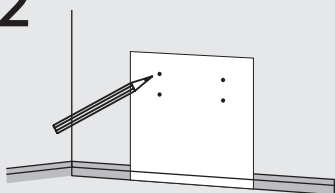

2.3

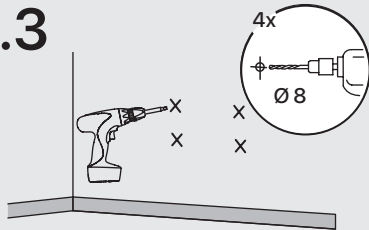

2.4

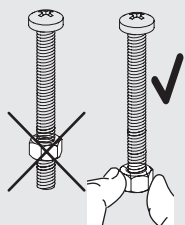

2.5

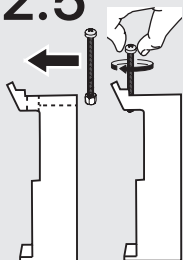

2.6

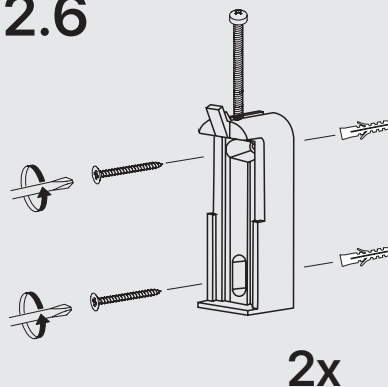

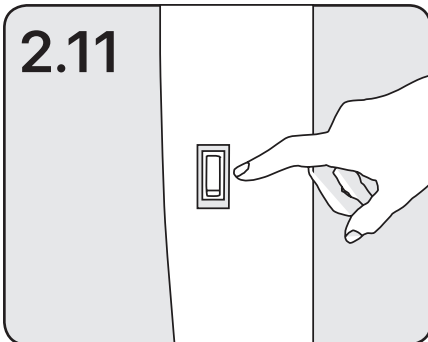
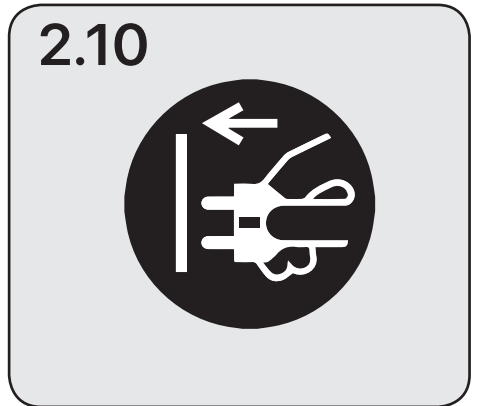
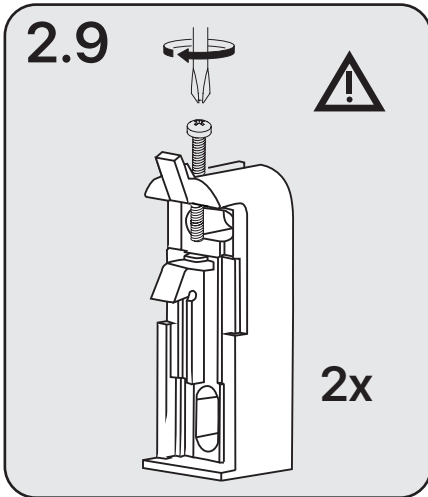
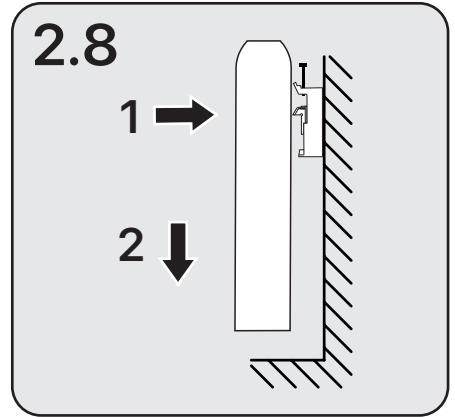
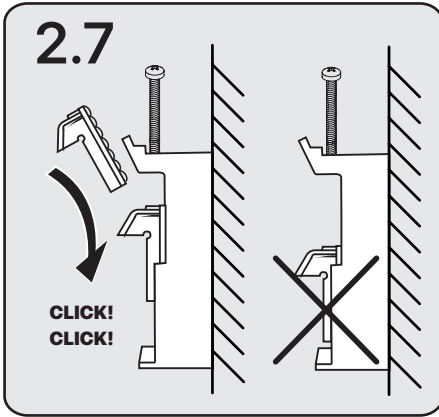

i

(W)	"A" (mm)	"B" (mm)	"C" (mm)
600	420	246	159
900	420	246	319
1200	420	246	478
1500	420	246	638
1800	420	246	638

3.1 PANEL DE CONTROL

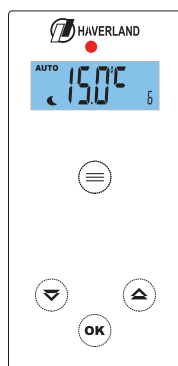

Tecla	Descripción
	Modos AUTO / OFF / ANTIHIELO / MANUAL
	Disminuir
	Aumentar
	Aceptar
	Indicador de color de la temperatura seleccionada

3.2 PANTALLA



AUTO	Indicador Modo AUTOMÁTICO
	Indicador Modo ANTIHIELO / CONFORT / MANUAL / ECONOMÍA
OFF	APAGADO
	Temperatura / Reloj
	Indicador de resistencia conectada
	Funciones Avanzadas

3.3 INICIO - PRIMERA CONEXIÓN

En el momento que se conecta el radiador a la red eléctrica y se pulsa el interruptor, situado en el lateral derecho:

- 1 Se muestra en la pantalla todos los iconos:



- 2 A continuación, aparece una segunda pantalla con la versión del software:



- 3 En la tercera pantalla:

- **Si antes de la desconexión, el radiador estaba en modo MANUAL / ANTIHIELO / OFF:**
 - Se muestra la pantalla principal en modo MANUAL / ANTIHIELO / OFF. **Si utiliza el radiador en modo manual o en modo antihielo, no será necesario ajustar la hora y el día actual.**
- **Si antes de la desconexión, el radiador estaba en modo AUTO:**
 - Si es la primera vez o **el radiador ha estado más de 6 horas desconectado de la corriente eléctrica, el radiador le solicitará ajustar la hora y el día actual.**
 - Si no es la primera vez o el radiador no ha estado desconectado más de 6 horas, se muestra la pantalla principal.



Si el tiempo de desconexión eléctrica es menor de 6 horas, se mantiene en memoria la hora y el día actual de la semana; incluso recuerda el último modo de funcionamiento.



La programación y las temperaturas seleccionadas se mantienen siempre en memoria.

3.4 MODOS DE FUNCIONAMIENTO

El radiador dispone de 4 modos de funcionamiento: **AUTO** / **OFF** / **ANTIHIELO** / **MANUAL**.

Para seleccionar el modo de funcionamiento, pulse sucesivamente la tecla .

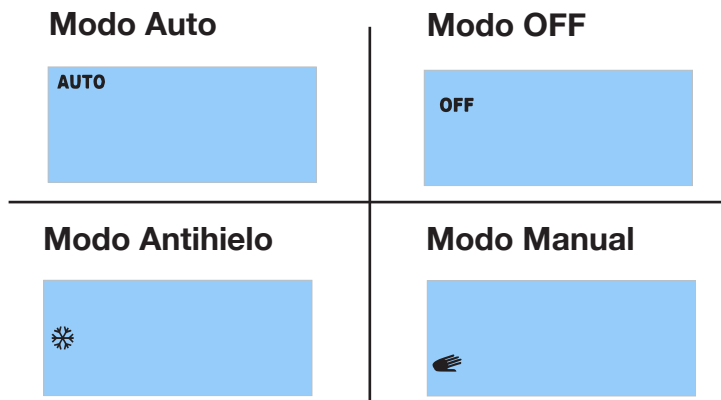

Una vez seleccionado el modo de funcionamiento, pulse la tecla  para confirmar.

3.4.1 MODO AUTO (PROGRAMACIÓN)

El radiador sigue la programación realizada según sus necesidades y de acuerdo con las temperaturas seleccionadas en cualquier modo de funcionamiento.

Paso 1: Para seleccionar el modo AUTO, pulse sucesivamente la tecla  hasta que **AUTO** aparezca en la pantalla.



IMPORTANTE: Si al elegir el modo AUTO, la hora y el día actual no están correctamente configuradas, el radiador le solicitará la hora y el día actual (vea la página 23, paso 3).

Paso 2: Pulse la tecla  para confirmar.



El símbolo “llama” indicará que el radiador está calentando; la temperatura ambiente es menor que la temperatura seleccionada. En el momento que la temperatura seleccionada se alcance, el símbolo desaparecerá de la pantalla.



Presione la tecla  si desea conocer la temperatura ambiente.

3.4.2 MODO OFF

Paso 1:

Pulse sucesivamente la tecla  hasta que aparezca **OFF** en la pantalla.

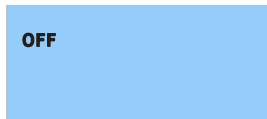

Paso 2:

Pulse la tecla  para confirmar. El radiador permanece apagado.





Para conectar el radiador, pulse sucesivamente la tecla  y elija el modo de funcionamiento que desee, AUTO, ANTIHIELO o MANUAL.

Pulse la tecla  para confirmar.

3.4.3 MODO ANTIHIELO

La **temperatura fijada de fábrica es de 7 °C**. Este modo se utiliza para largos periodos de ausencia en los que se quiere evitar que se congelen las tuberías.

Paso 1:

Pulse sucesivamente la tecla  hasta que aparezca  en la pantalla.

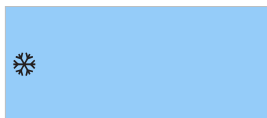

Paso 2:

Pulse la tecla  para confirmar.



Presione la tecla  si desea conocer la temperatura ambiente.

3.4.4 MODO MANUAL

Si no desea programar su radiador, le recomendamos elegir el modo MANUAL, en el que puede seleccionar la temperatura deseada entre 12 y 30 °C.

Le recomendamos elegir una temperatura entre 20 - 21 °C.

Paso 1: Pulse sucesivamente la tecla  hasta que aparezca  en la pantalla.



Paso 2: Pulse la tecla  para confirmar. Se muestra la temperatura prefijada en modo manual.



Paso 3: Pulse la tecla  o  para definir la temperatura deseada. Pulse la tecla  para confirmar.



El ajuste se podrá realizar entre un mínimo de 12 °C y un máximo de 30 °C.



Durante la elección de la temperatura deseada, un piloto luminoso situado encima de la pantalla cambiará de color según la temperatura de consigna elegida.

- **Rojo** si la temperatura elegida es igual o mayor de 24 °C.
- **Naranja** si la temperatura elegida está entre 19,5 y 23,5 °C.
- **Verde** si es menor a 19,5°C.



Este símbolo le indicará que el radiador está calentando; la temperatura ambiente es menor que la temperatura seleccionada. En el momento que la temperatura de consigna se alcance, el símbolo desaparecerá de la pantalla.



- Recomendamos seleccionar una temperatura entre 20 y 21 °C.
- Presione la tecla  si desea conocer la temperatura ambiente.

3.5 MENÚ USUARIO

Con este menú podrá acceder y ajustar los siguientes parámetros:



- **1:** ELEGIR LA TEMPERATURA CONFORT.
- **2:** ELEGIR LA TEMPERATURA ECONOMÍA.
- **3:** ELEGIR LA TEMPERATURA ANTIHIELO.
- **4:** CALIBRAR LA TEMPERATURA AMBIENTE.
- **5:** AJUSTAR EL DÍA DE LA SEMANA (El radiador debe estar en modo **AUTO**).
- **6:** AJUSTAR EL RELOJ (El radiador debe estar en modo **AUTO**).
- **7:** REALIZAR UNA PROGRAMACIÓN DIARIA O SEMANAL.
- **8:** ACTIVAR O DESACTIVAR LA FUNCIÓN “VENTANAS ABIERTAS”.
- **9:** ACTIVAR O DESACTIVAR LA FUNCIÓN INTELIGENTE “ITCS”.
- **10:** CONOCER SU CONSUMO ELÉCTRICO DIARIO, SEMANAL O MENSUAL.

3.5.1 ¿CÓMO ACCEDER AL MENÚ USUARIO?

1 Pulse sin soltar la tecla  .

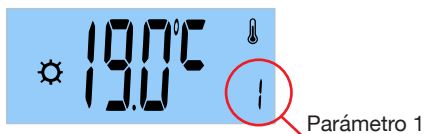
2 En la pantalla aparecerán unas rayas horizontales. A continuación, se mostrará el **parámetro 1**, “Selección Temperatura de Confort”.



3 Pulsando la tecla  o  podrá elegir, de los 10 parámetros disponibles, el parámetro a modificar.

**PARÁMETRO 1
SELECCIÓN TEMPERATURA
CONFORT**



**PARÁMETRO 2
SELECCIÓN
TEMPERATURA ECONOMÍA**



**PARÁMETRO 3
SELECCIÓN
TEMPERATURA ANTIHIELO**



**PARÁMETRO 4
CALIBRACIÓN TEMPERATURA**



**PARÁMETRO 5
AJUSTE DÍA SEMANA (solo en AUTO)**

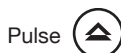

**PARÁMETRO 10
INDICADOR DE
CONSUMO**



**PARÁMETRO 9
SELECCIÓN
FUNCIÓN "ITCS"**



**PARÁMETRO 8
SELECCIÓN VENTANAS
ABIERTAS**



**PARÁMETRO 7
PROGRAMACIÓN**



**PARÁMETRO 6
AJUSTE HORA (solo en AUTO)**

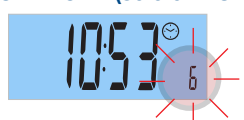







1 PARÁMETRO 1: SELECCIONAR TEMPERATURA CONFORT

El radiador permite **realizar una programación día a día, hora a hora. Cada día de la semana podrá elegir confort, economía, antihielo o apagado.**

La temperatura confort es la temperatura que se desea tener en las horas de ocupación en la estancia.

El **parámetro 1** permite ajustar la temperatura confort preestablecida:

<p>Paso 1: Acceda al menú usuario pulsando continuamente la tecla . Se muestra el Parámetro 1.</p>	
<p>Paso 2: Pulse la tecla  para confirmar.</p>	
<p>Paso 3: Pulse la tecla  o  para elegir la temperatura de confort deseada. Pulse la tecla  para confirmar.</p>	



- El ajuste de la temperatura confort se podrá realizar entre 16 y 30 °C.
- Recomendamos elegir una temperatura confort entre 20 y 21 °C.



Durante la elección de la temperatura deseada, un piloto luminoso situado encima de la pantalla cambiará de color según la temperatura de consigna elegida.

- **Rojo** si la temperatura elegida es igual o mayor de 24 °C.
- **Naranja** si la temperatura elegida está entre 19,5 y 23,5 °C.
- **Verde** si es menor a 19,5°C.











Las temperaturas en cada modo de funcionamiento vienen preestablecidas de fábrica. Son las temperaturas recomendadas para su confort, para un consumo eléctrico razonable, no es aconsejable superar estas temperaturas.

2 PARÁMETRO 2: SELECCIONAR LA TEMPERATURA DE ECONOMÍA

La temperatura de economía es la temperatura que se desea durante la noche o en los periodos cortos de ausencia. Evita que disminuya en exceso la temperatura ambiente de la estancia.

Para modificar la temperatura de economía preestablecida:

<p>Paso 1: Acceda al menú usuario, pulsando continuamente la tecla . Se muestra el Parámetro 1.</p>	 <p>Parámetro 1</p>
<p>Paso 2: Pulse sucesivamente la tecla  o  hasta elegir el parámetro 2. Pulse la tecla  para confirmar.</p>	 <p>Parámetro 2</p>
<p>Paso 3: Pulse la tecla  o  para seleccionar la temperatura de economía deseada. Pulse la tecla  para confirmar.</p>	



- El ajuste de la temperatura de economía se podrá realizar entre 12 y 18,5 °C.
- Recomendamos elegir una temperatura de economía entre 15 y 17 °C.











Durante la elección de la temperatura economía, el piloto luminoso situado encima de la pantalla estará en color **Verde**.

3 PARÁMETRO 3: SELECCIONAR TEMPERATURA ANTIHIELO

La temperatura antihielo es la temperatura que se utiliza para largos periodos de ausencia, evitando que se congelen las tuberías en su vivienda.

Para modificar la temperatura antihielo preestablecida:

<p>Paso 1: Acceda al menú usuario pulsando continuamente la tecla . Se muestra el Parámetro 1.</p>	
<p>Paso 2: Pulse sucesivamente la tecla  o  hasta elegir el parámetro 3. Pulse la tecla  para confirmar.</p>	
<p>Paso 3: Pulse la tecla  o  para elegir la temperatura antihielo deseada. Pulse la tecla  para confirmar.</p>	



- El ajuste de la temperatura de antihielo se podrá realizar entre 5 y 10 °C.
- Recomendamos elegir una temperatura de antihielo entre 5 y 7 °C.



Durante la definición de la temperatura antihielo, el piloto luminoso situado encima de la pantalla estará de color **Verde**.

4 PARÁMETRO 4: CALIBRACIÓN DE LA TEMPERATURA

El parámetro 4 permite ajustar la temperatura ambiente que mide el radiador. Esta calibración compensa una posible diferencia entre la temperatura obtenida en la habitación y la temperatura que ha programado en el radiador.

La calibración debe realizarse después de 1 día de funcionamiento y si existe mucha diferencia entre la temperatura de la habitación y la temperatura ambiente medida por el radiador.

1. Coloque un termómetro de precisión en la estancia retirado del radiador.
2. Después de una hora calentando, anote la temperatura medida en el termómetro de precisión.

<p>Paso 1: Acceda al menú usuario, pulsando continuamente la tecla . Se muestra el Parámetro 1.</p>	
<p>Paso 2: Pulse sucesivamente la tecla  o  hasta seleccionar el parámetro 4. En la pantalla se muestra alternativamente la temperatura ambiente en la sala y el valor de compensación.</p>	
<p>Paso 3: Pulse la tecla  para confirmar.</p>	
<p>Paso 4: Pulsando la tecla  o  introduzca el valor de la temperatura anotada anteriormente. Una vez introducido el valor de temperatura, pulse la tecla  para confirmar. En la pantalla se muestra alternativamente la nueva temperatura y el valor de compensación resultante (Por ejemplo, de 22 a 24 °C).</p>	



El rango de compensación es de + 5 °C / - 5 °C.

5 PARÁMETRO 5: AJUSTAR DÍA DE LA SEMANA



El radiador debe estar en modo AUTO.

MODO AUTO



El día de la semana se ajusta automáticamente al configurar el día, mes y el año en curso.

<p>Paso 1: Acceda al menú usuario pulsando continuamente la tecla . Se muestra el Parámetro 1.</p>	<p>Parámetro 1</p>
<p>Paso 2: Pulse sucesivamente la tecla o hasta seleccionar el parámetro 5. En la pantalla se muestra alternativamente el día, mes y año. Pulse la tecla para continuar.</p>	
<p>Paso 3: Pulsando la tecla o seleccione el año en curso. Pulse la tecla para confirmar.</p>	<p>AÑO</p>
<p>Paso 4: Pulsando la tecla o seleccione el mes en curso. Pulse la tecla para confirmar.</p>	<p>MES</p>
<p>Paso 5: Seleccione el día en curso, pulsando la tecla o . Pulse la tecla para confirmar.</p>	<p>DÍA</p>
<p>Paso 6: Para finalizar, pulse la tecla .</p>	

6 PARÁMETRO 6: AJUSTE DE HORA



El radiador debe estar en modo AUTO.

MODO AUTO



Podrá editar la hora y los minutos (formato horario de 24 horas).



<p>Paso 1: Acceda al menú usuario pulsando continuamente la tecla . Se muestra el Parámetro 1.</p>	 <p>Parámetro 1</p>
<p>Paso 2: Pulse sucesivamente la tecla  o  hasta seleccionar el parámetro 6. En la pantalla se muestra alternativamente la hora y los minutos. Pulse la tecla  para continuar.</p>	 <p>Parámetro 6</p>
<p>Paso 3: Pulsando la tecla  o  seleccione la hora. Pulse la tecla  para confirmar.</p>	 <p>HORA</p>
<p>Paso 4: Seleccione los minutos, pulsando la tecla  o . Pulse la tecla  para confirmar.</p>	 <p>MINUTOS</p>
<p>Paso 5: Para finalizar, pulse la tecla .</p>	

7 PARÁMETRO 7: PROGRAMACIÓN

Su radiador puede funcionar de forma manual o automática (con programación).

Teniendo en cuenta sus necesidades, sensación de confort, orientación y permanencia en la vivienda, el radiador le ofrece la posibilidad de crear un programa individual.

Tiene 3 opciones para programar su radiador: “dAY” / “PART” / “ALL”.

OPCIONES	EXPLICACIÓN PROGRAMA
<p>OPCIÓN “DAY”</p> 	<p>¿No tiene una rutina diaria? ¿Cada día de la semana es diferente? Elija la opción “DAY” para configurar un programa diferente para cada día de la semana. Si su rutina diaria es distinta para cada día de la semana, le recomendamos esta opción.</p>
<p>OPCIÓN “PART”</p> 	<p>¿Su rutina diaria se repite de lunes a viernes? ¿Su rutina es igual el fin de semana? Elija la opción “PART” si desea una programación de lunes a viernes y otra distinta para el fin de semana.</p>
<p>OPCIÓN “ALL”</p> 	<p>Elija la opción “ALL” si desea la misma programación para todos los días de la semana. Esta opción es ideal para usuarios que tienen la misma rutina diaria toda la semana.</p>













Por defecto, la programación semanal configurada desde fábrica es:

- **De Lunes a Viernes:**

El radiador funciona en modo confort desde las 06 h hasta las 09 h, desde las 12 h hasta las 14 h y desde 18h hasta las 23 h. El resto de horas, el radiador estará en modo economía.





- **De Sábado a Domingo:**

El radiador funciona en modo confort desde las 08 h hasta las 23 h. El resto de horas, el radiador estará en modo economía.

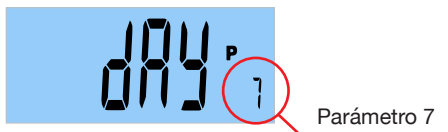
<p>Paso 1: Acceda al menú usuario pulsando continuamente la tecla . Se muestra el Parámetro 1.</p>	 <p>Parámetro 1</p>
<p>Paso 2: Pulse sucesivamente la tecla  o  hasta seleccionar el parámetro 7. En la pantalla se muestra PROG. Pulse la tecla  para continuar.</p>	 <p>Parámetro 7</p>
<p>Paso 3: Pulsando la tecla  o  y según la tabla anterior, seleccione una de las tres opciones para programar su radiador.</p> <p>Pulse la tecla  para confirmar la opción deseada.</p>	
<p>Paso 4:</p> <ul style="list-style-type: none"> • Si ha elegido la opción “dAY”, continúe en la página 24. • Si ha elegido la opción “PARt”, continúe en la página 27. • Si ha elegido la opción “ALL”, continúe en la página 30. 	

7.1 Si ha elegido la opción de programación “dAY”:



<p>Paso 5: Pulse la tecla  para empezar a configurar esta opción. Aparece día 1 (1 = Lunes). La programación comienza el primer día de la semana y a las 00 h.</p>	<p>LUNES</p>
<p>Paso 6: Para moverse de un día a otro pulse la tecla  o  :</p> <p>1 = Lunes, 2 = Martes, 3 = Miércoles, 4 = Jueves, 5 = Viernes, 6 = Sábado, 7 = Domingo</p>	<p>MARTES</p>
<p>Paso 7: Una vez elegido el día de la semana, pulse  para confirmar.</p> <p>En la pantalla se indica 00 h (12 de la noche) del día de la semana elegido y modo ECONOMÍA.</p> <p>A continuación, seleccione un modo de funcionamiento hora a hora:</p>	<p>ECONOMÍA</p> <p>HORA</p>

Paso 8: En la primera franja horaria, 00 h a 01 h, pulse sucesivamente la tecla  para seleccionar el modo de funcionamiento: confort, OFF, antihielo o economía. ¿Qué modo de funcionamiento elegir?



MODO CONFORT

Seleccione **Modo CONFORT** si en la franja horaria está ocupada la estancia.

En este modo, el radiador funcionará según la temperatura de confort elegida en el **parámetro 1**.



MODO APAGADO

Seleccione **Modo APAGADO** si en la franja horaria no necesita calefacción en la habitación.



MODO ANTIHIELO

El modo **ANTIHIELO** se suele utilizar para largos periodos de ausencia en los que se quiere evitar problemas de congelación de tuberías.

En este modo, el radiador funcionará según la temperatura de antihielo elegida en el **parámetro 3**.



MODO ECONOMÍA

El **Modo ECONOMÍA** se utiliza durante la noche o en periodos cortos de ausencia. Evita que la temperatura ambiente disminuya en exceso.

En este modo, el radiador funcionará según la temperatura de confort elegida en el **parámetro 2**.

Paso 9: Una vez elegido el modo de funcionamiento para la franja horaria de 00:00 a 01:00h, pulse la tecla  para pasar a configurar la franja horaria siguiente. Repita este proceso hora a hora.

3. FUNCIONAMIENTO

ES



Pulse la tecla  o  para desplazarse por cada franja horaria.

Paso 10: En la última franja horaria del día, aparece en la **pantalla END**.

Paso 11: Para confirmar la programación, pulse la tecla  .

Paso 12: Para salir del menú de programación, pulse la tecla  .

Una vez configurado el programa horario, el radiador obedecerá el programa configurado siempre y cuando **el modo de funcionamiento elegido sea el modo AUTO**.



ES











Pulse dos veces la tecla  para salir de menú de programación, **SIN GUARDAR LOS DATOS**.

7.2 Si ha elegido la opción de programación "Part":



Podrá configurar dos tramos: de lunes a viernes y de sábado a domingo.

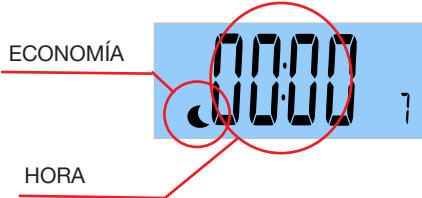

La programación que se realice el lunes, se repetirá hasta el viernes y la programación que se realice el sábado, se repetirá el domingo.













<p>Paso 5: Pulse la tecla  para empezar a configurar esta opción. Se muestra en pantalla 1 - 5 (Lunes a Viernes).</p>	
<p>Paso 6: Pulse la tecla  o  para elegir el tramo de lunes a viernes (1-5) o el tramo de sábado a domingo (6-7).</p> <div style="display: flex; justify-content: space-around; align-items: center;">   </div>	
<p>Paso 7: Una vez elegido el tramo de la semana, pulse  para confirmar. En la pantalla se indica 00 h (12 de la noche) del primer día del tramo elegido y además, modo ECONOMÍA.</p> <div style="text-align: center;">  </div>	
<p>Paso 8: Para la primera franja horaria de 00 h a 01 h del lunes, pulse sucesivamente la tecla  para elegir el modo de funcionamiento deseado: confort, OFF, antihielo o economía.</p>	
<p>Paso 9: Una vez elegido el modo de funcionamiento para la franja horaria de 00 h a 01 h, pulse la tecla  para pasar a la franja horaria siguiente. Repita este proceso para cada franja horaria.</p>	

3. FUNCIONAMIENTO

ES



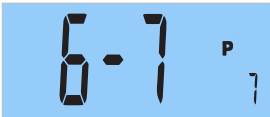

Pulse la tecla  o  para desplazarse por cada franja horaria.

<p>Paso 10: En la última franja horaria del día, aparece END, en la pantalla.</p>	
<p>Paso 11: Pulse la tecla  . El programa realizado el lunes, se repetirá hasta el viernes.</p>	
<p>Paso 12: Para comenzar a programar la franja de sábado a domingo, pulse la tecla  .</p>	
<p>Paso 13: Pulse la tecla  o  para elegir de nuevo la opción PArt.</p>	
<p>Paso 14: Pulse la tecla  . Se muestra 1 - 5 (Lunes a Viernes).</p>	
<p>Paso 15: Pulse la tecla  o  para seleccionar el tramo de sábado a domingo (6-7).</p>	

ES

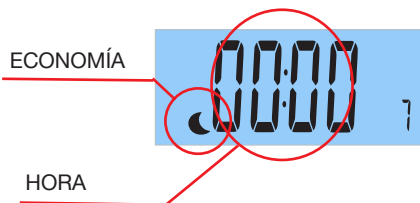
Paso 16: Pulse  para confirmar. En la pantalla se indica **00 h (12 de la noche) del sábado** y además, modo **ECONOMÍA**.



Paso 17: Para la primera franja horaria de 00 h a 01 h del lunes, pulse sucesivamente la tecla  para elegir el modo de funcionamiento deseado: confort, OFF, antihielo o economía.

Paso 18: Una vez elegido el modo de funcionamiento para la franja horaria de 00 h a 01 h, pulse la tecla  para pasar a la franja horaria siguiente. Repita este proceso para cada franja horaria.

Paso 19: En la última franja horaria del día, aparece en la **pantalla END**.



Paso 20: Para salir del menú de programación, pulse la tecla . El programa realizado el sábado, se repetirá también el domingo.



Pulse dos veces la tecla  para salir de menú de programación, **SIN GUARDAR LOS DATOS**.

7.3 Si ha elegido la opción de programación “ALL”:



Podrá configurar el mismo programa de lunes a domingo. La programación que se realice el lunes, se repetirá hasta el domingo.

Paso 16: Pulse  para confirmar. En la pantalla se indica **00 h (12 de la noche) del sábado** y además, modo **ECONOMÍA**.

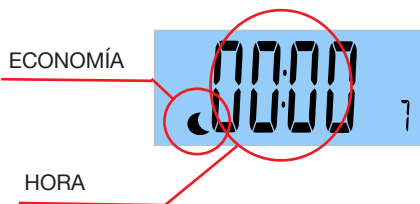

Paso 17: Para la primera franja horaria de 00 h a 01 h del lunes, pulse sucesivamente la tecla  para elegir el modo de funcionamiento deseado: confort, OFF, antihielo o economía.

Paso 18: Una vez elegido el modo de funcionamiento para la franja horaria de 00 h a 01 h, pulse la tecla  para pasar a la franja horaria siguiente. Repita este proceso para cada franja horaria.

Paso 19: En la última franja horaria del día, aparece en la **pantalla END**.



Paso 20: Para salir del menú de programación, pulse la tecla . El programa realizado el lunes, se repetirá hasta el domingo.

Una vez configurado la programación, el radiador obedecerá siempre y cuando **el modo de funcionamiento elegido sea el modo AUTO**.





Pulse dos veces la tecla  para salir de menú de programación, SIN GUARDAR LOS DATOS.



IMPORTANTE: Anulación temporal de un programa en curso

Esta función permite modificar la temperatura de consigna temporalmente hasta el próximo cambio programado de temperatura o cuando haya transcurrido más de 2 horas desde la modificación.

Paso 1: Con el radiador en modo Auto, pulse la tecla  o  para modificar temporalmente la temperatura de consigna.

Paso 2: Pulse  para confirmar.

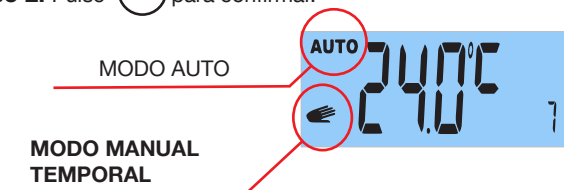

Esta modificación se cancelará automáticamente en el próximo cambio de programa o cuando haya transcurrido más de 2 horas desde la modificación.













IMPORTANTE:

- El radiador obedecerá según el modo de funcionamiento (confort / economía / anti-hielo / OFF) que visualicemos en la pantalla.
- No olvide que el radiador debe estar en modo AUTO para que se cumpla la programación configurada.
- Siempre podrá modificar las temperaturas asignadas para el modo confort, economía o antihielo, modificando el parámetro 1, parámetro 2 o parámetro 3, respectivamente.
- La temperatura que se muestra en la pantalla es la temperatura programada en el modo de funcionamiento en curso.
- El símbolo  aparecerá siempre que la resistencia del aparato esté funcionando.

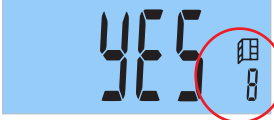
8 PARÁMETRO 8: FUNCIÓN AHORRO “VENTANAS ABIERTAS”

Esta función se activa cuando se produce un descenso brusco de la temperatura en la habitación. Al cerrar la ventana, el radiador detectará una subida de temperatura y el radiador calentará de nuevo volviendo al estado anterior a la desconexión.

Esta función inteligente está activada de serie. Puede ser desactivada si lo desea.

<p>Paso 1: Acceda al menú usuario pulsando continuamente la tecla . Se muestra el Parámetro 1.</p>	
<p>Paso 2: Pulse sucesivamente la tecla  o  hasta elegir el parámetro 8. Pulse la tecla  para confirmar.</p>	
<p>Paso 3: Pulse la tecla  o  para activar o desactivar la función. Pulse la tecla  para confirmar.</p> <div style="display: flex; justify-content: space-around; align-items: center;"> <div data-bbox="241 940 510 1054" style="text-align: center;">  <p>Función Activada</p> </div> <div data-bbox="608 940 876 1054" style="text-align: center;">  <p>Función Desactivada</p> </div> </div>	
<p>Paso 4: Para salir del menú de programación, pulse la tecla .</p>	













Pulse dos veces la tecla  para salir de menú de programación, SIN GUARDAR LOS DATOS.

9 PARÁMETRO 9: FUNCIÓN INTELIGENTE “ITCS”

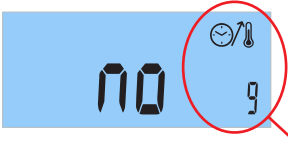
El radiador incorpora un **innovador sistema de control inteligente de temperatura ITCS**.

Este sistema activa la puesta en marcha del aparato con **antelación a la hora programada** (2 horas máximo), para asegurar que se consigue la temperatura deseada a la hora indicada y siguiendo el programa semanal establecido.

Esta función inteligente está activada de serie. Puede ser desactivada si lo desea.

<p>Paso 1: Acceda al menú usuario pulsando continuamente la tecla . Se muestra el Parámetro 1.</p>	 <p>Parámetro 1</p>
<p>Paso 2: Pulse sucesivamente la tecla  o  hasta elegir el parámetro 9. Pulse la tecla  para confirmar.</p>	 <p>Parámetro 9</p>
<p>Paso 3: Para activar o desactivar la función, pulse la tecla  o . Pulse la tecla  para confirmar.</p> <div style="display: flex; justify-content: space-around; align-items: center;"> <div data-bbox="224 949 492 1069">  <p>Función Desactivada</p> </div> <div data-bbox="588 949 856 1069">  <p>Función Activada</p> </div> </div>	
<p>Paso 4: Para salir del menú de programación, pulse la tecla .</p>	



Pulse dos veces la tecla  para salir del menú de programación, **SIN GUARDAR LOS DATOS**.

10 PARÁMETRO 10: FUNCIÓN “INDICADOR DE CONSUMO”

El radiador incorpora una función única en el mercado que le permite conocer su consumo eléctrico las últimas 24 horas, los últimos 7 días y los últimos 30 días.



- **Importante:** Antes de conocer el consumo eléctrico, debe introducir el valor de la potencia de su radiador (ver página 39).
- El radiador memoriza el dato de consumo cada 4 horas.



<p>Paso 1: Acceda al menú usuario, pulsando continuamente la tecla . Se muestra el Parámetro 1.</p>	
<p>Paso 2: Pulse sucesivamente la tecla o hasta elegir el parámetro 10. Pulse la tecla para confirmar.</p>	
<p>En la pantalla se muestra alternativamente, el consumo (en KWh) durante las últimas 24 horas:</p>	
<p>Consumo en KWh</p>	
<p>Paso 3: Pulse sucesivamente la tecla o para conocer el consumo eléctrico durante los últimos 7 días y los últimos 30 días.</p>	
<p>Paso 4: Para salir del menú, pulse dos veces la tecla .</p>	



En la opción “consumo últimas 24 horas” puede conocer el consumo total del radiador desde el primer día de funcionamiento, pulsando continuamente la tecla .



11 PARÁMETRO 11: END

Paso 1: Ha llegado al final del menú usuario.	
Paso 2: Pulse la tecla  para salir del menú usuario.	

3.6 MENÚ AVANZADO

Con el menú avanzado podrá acceder y ajustar los siguientes parámetros:

- **1:** SELECCIÓN GRADOS CELSIUS °C o FARENHEIT °F.
- **2:** ACTIVAR o DESACTIVAR LA FUNCIÓN “FIL PILOTE” (para Francia). Se necesita centralita (no incluida).
- **3:** INDICACIÓN VERSIÓN DE SOFTWARE.
- **4:** AJUSTE VALOR POTENCIA DEL RADIADOR.
- **5:** FUNCIÓN RESETEO.
- **6:** FIN MENÚ AVANZADO.

3.6.1 ¿CÓMO ACCEDER AL MENÚ AVANZADO?

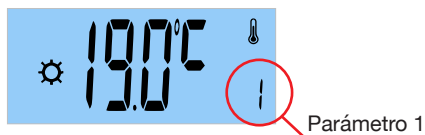

Paso 1: Pulse sin soltar la tecla . En la pantalla aparecerá unas rayas horizontales y a continuación, se mostrará el parámetro 1, “Selección Temperatura de Confort”.



Paso 2: Pulse sucesivamente la tecla  o  hasta elegir el **parámetro 11 “END”**.







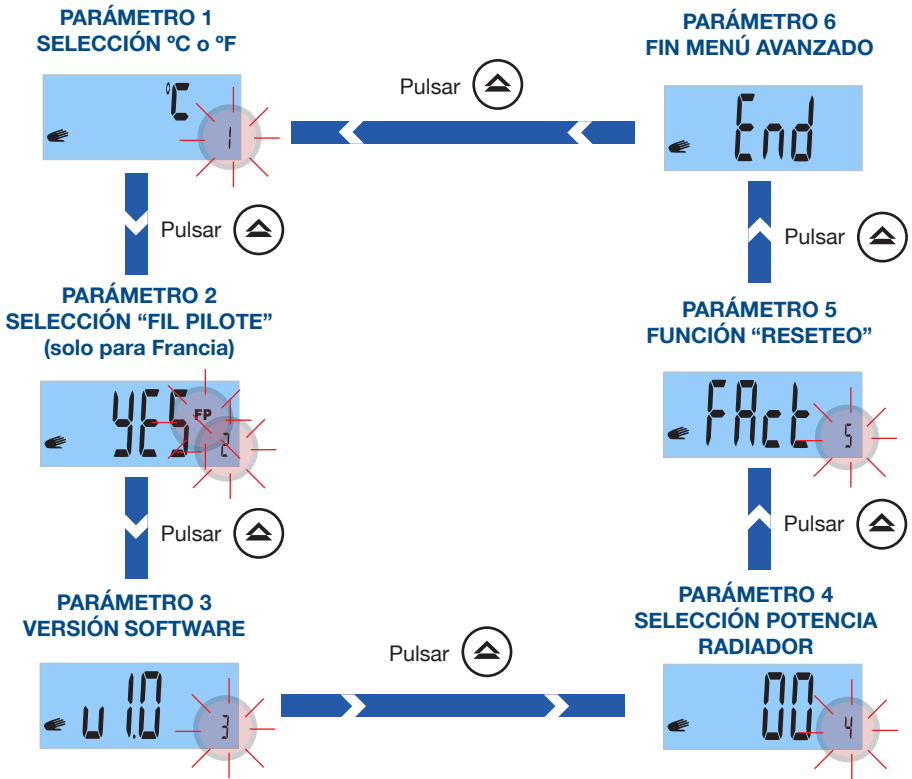



Paso 3: Pulse sin soltar de nuevo la tecla . En la pantalla aparecerán unas rayas horizontales. A continuación, se mostrará el **parámetro 1, “ELECCIÓN GRADOS CELSIUS °C / FARENHEIT °F”**.

Paso 4: Pulse la tecla  o  para seleccionar el parámetro avanzado que se desea modificar.













1 PARÁMETRO 1: SELECCIONAR GRADOS CELSIUS / FARENHEIT

Seleccione grados Celsius (°C) o grados Fahrenheit (°F).

<p>Paso 1: Acceda al menú avanzado.</p>	
<p>Paso 2: Pulse la tecla  para confirmar.</p>	
<p>Paso 3: Pulse la tecla  o  para elegir °C o °F. Pulse la tecla  para confirmar.</p>	
<p>Paso 4: Pulse la tecla  o  para seleccionar otro parámetro avanzado o pulse la tecla  para salir del menú avanzado.</p>	





2 PARÁMETRO 2: SELECCIÓN FUNCIÓN “FIL PILOTE” (solo para Francia y necesaria una centralita no incluida)

Esta función solo está operativa en Francia. Para activar o desactivar esta función, siga estos pasos:

<p>Paso 1: Acceda al menú avanzado. Con la tecla  o  seleccione 2.</p>	
<p>Paso 2: Pulse la tecla  para confirmar.</p>	
<p>Paso 3: Pulse la tecla  o  para elegir Yes (Sí) o No. Pulse la tecla  para confirmar.</p>	
<p>Paso 4: Pulse la tecla  o  para seleccionar otro parámetro avanzado o pulse la tecla  para salir del menú avanzado.</p>	

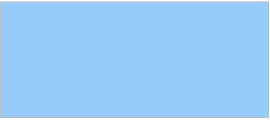
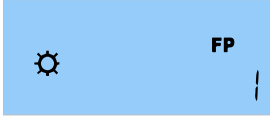

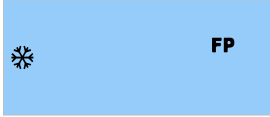



La función “Fil Pilote” funciona únicamente en modo **MANUAL**.

Una vez elegida la temperatura en el modo manual, las distintas órdenes “Fil Pilote” se comportan de la siguiente manera:

ORDEN “FIL PILOTE”	PANTALLA
Confort (No hay orden)	
Confort - 1°	
Confort - 2°	
Economía	
Antihielo	
OFF	











3 PARÁMETRO 3: VERSIÓN SOFTWARE

Indica la versión actual del software de su radiador.

<p>Paso 1: Acceda al menú avanzado. Con la tecla  o  seleccione 3.</p>	 <p>Parámetro 1</p>
<p>Paso 2: Se muestra la versión de software de su radiador.</p>	
<p>Paso 3: Pulse la tecla  o  para seleccionar otro parámetro avanzado o pulse la tecla  para salir del menú avanzado.</p>	

4 PARÁMETRO 4: SELECCIONAR POTENCIA DEL RADIADOR





Para que el parámetro 10 “indicador de consumo” funcione correctamente debe introducir el valor de la potencia de su radiador. **La potencia (vatios) está indicada en la etiqueta gris situada en el lateral derecho del radiador al lado del cable de alimentación.**

<p>Paso 1: Acceda al menú avanzado. Con la tecla  o  seleccione 4.</p>	 <p>Parámetro 1</p>
<p>Paso 2: Pulse la tecla  para confirmar.</p>	
<p>Paso 3: Pulse la tecla  o  para seleccionar la potencia de su radiador (por ejemplo 1000 W). Pulse la tecla  para confirmar.</p>	
<p>Paso 4: Pulse la tecla  o  para seleccionar otro parámetro avanzado o pulse la tecla  para salir del menú avanzado.</p>	

5 PARÁMETRO 5: “RESETEO”

Este parámetro nos permite:

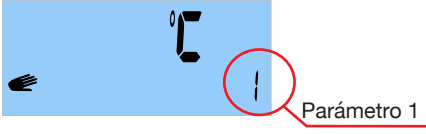
- **Borrar la programación del radiador.**
- **Borrar todos los parámetros, excepto la potencia de su radiador (Parámetro avanzado 4, página 39).**

<p>Paso 1: Acceda al menú avanzado. Con la tecla  o  seleccione 5.</p>	
<p>Paso 2: Para resetear el radiador a valores iniciales de fábrica, pulse sin soltar la tecla .</p>	
<p>Paso 3: Comenzará el proceso de “reseteo” de su radiador.</p> <p>Una vez finalizado el proceso de “reseteo”, el radiador retornará a modo manual con la temperatura prefijada de fábrica (20 °C).</p> <p>A continuación, elija el modo de funcionamiento deseado. Si elige el modo AUTO, deberá configurar la hora y el día actual. Programe de nuevo su radiador y configure los parámetros que desee.</p>	

6 PARÁMETRO 6: END

<p>Paso 1: Ha llegado al final del menú avanzado.</p>	
<p>Paso 2: Pulse la tecla  o  para salir del menú avanzado.</p>	

3.7 FUNCIÓN “BLOQUEO DE TECLADO”

Presione simultáneamente las teclas  y  hasta que aparezca en la pantalla **el símbolo de una llave**.



Repita la misma operación para desbloquear el teclado hasta que el símbolo de la llave desaparezca.



Si se produce un corte de la corriente eléctrica con la función de “bloqueo de teclado” activada, el radiador continuará con “bloqueo de teclado activada”.

3.8 MENSAJE ERROR “ERR”

Si en la pantalla aparece la palabra “Err” parpadeando, el sensor de su termostato se ha desconectado o averiado. Consulte con nuestro Servicio Postventa Haverland.



4. MANTENIMIENTO

Su radiador no precisa de ningún tipo de mantenimiento especial.

Solamente limpie el polvo que se pueda acumular con un trapo seco y suave.

Es conveniente, al comenzar la temporada de invierno, limpiar con un plumero el polvo acumulado sobre la superficie del radiador y entre los elementos de aluminio.



NUNCA UTILICE DISOLVENTES NI PRODUCTOS ABRASIVOS.

- **Please read these instructions carefully.**
- To disconnect mains power from the radiator remove the plug from the wall socket, but **never pull on the cable.**
- Do not leave the mains cable in contact with the radiator when it is switched on.
- During operation, the radiator must be kept well away from combustible materials, such as curtains, carpets and furniture etc.
- **The warranty for the radiator does not cover any damage caused by not reading these instructions.**



WARNING: In order to avoid overheating, do not cover the heater.



• **WARNING:** If the mains power cable is damaged, it must be replaced by the manufacturer, with their after-sales service or similar qualified persons, in order to prevent any danger.



• **WARNING:** If the heater is to be installed in a bathroom, it must be positioned so that it cannot be touched by anybody in the bath or shower.

• **The installation should be carried out with consideration to the manufacturer's instructions and in accordance to the relevant National Wiring Regulations BS7671.**

• It is very important that radiator has a good Electric Earth connection.

• The radiator shall be installed so that its mains plug is always accessible.

• The radiator must not be installed below or in front of a mains socket.

• **This radiator cannot be surface-mounted with a wall. Safety distances shall always be respected.**

• **The radiator has a keyboard blockage option to prevent children from changing the programming.**

• This unit is not designed to be handled by persons (including children) with physical, sensorial or mental handicaps, with little

experience or knowledge unless they are under the supervision of an adult responsible for their safety with the instructions on its use. Children shall always be supervised to ensure they do not play with the unit.

- Children under three shall be kept well away from the heater unless they are continually supervised.
- Children between three and eight shall only switch the unit off or on providing it is positioned or installed in its final operating location and be supervised or have received instructions on how to use the unit in a safe manner and understand the risks involved.
- Children between three and eight shall not plug in, adjust or clean the heater or carry out any maintenance operations.
- This unit may be used by children older than eight and by persons with physical, sensorial or mental handicaps, with little experience or knowledge, provided they have been duly trained and are supervised by an adult that understands the risks involved.
- Cleaning and maintenance shall be performed by adults not children. Children must not play with the unit.



• **WARNING: Certain parts of this product can become very hot and cause burns.** Special attention shall be paid when children and other vulnerable persons are present.

- Do not touch the external parts of the radiator when it is operating.
- It is quite normal that, with the first switch-on, the unit produces a “new” smell. Allow your heater to operate in a well-ventilated place for two or three hours.
- Before the first switch on for the coming winter or when the heater has not been used for several days, the unit should be cleaned (follow the steps given in the “maintenance section”). This cleaning operation will avoid burning the accumulated dust and other remains.



• This radiator **CAN'T OPERATE** with external programmable controllers or any other exterior control device.

2. INSTRUCTIONS FOR INSTALLATION

EN



• **CAUTION:** Keep bags and other accessories well out of the reach of children.

• The convection effect, together with other ambient factors, can cause discolouring to metal surfaces and to plastics.

• Temperature differences can cause crackling and other noises in the unit. This does not indicate any failure in the radiator.

• When the radiator is disposed of, the requirements established by current legislation on waste processing and recycling shall be taken into account.



IMPORTANT

• It is important that the radiator **IS FIXED FIRMLY TO A SOLID AND LEVELLED WALL**.

• Make sure that there is a socket near the area where you are going to place it.

• Take out the wall pattern from the box to see the exact positions of the necessary drill holes.

• You must keep a minimum distance of 15 cm between the radiator and any object, wall or combustible material.

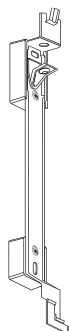
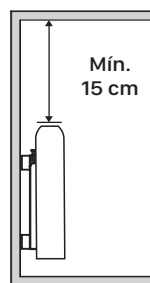
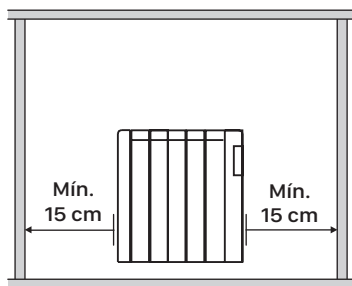

A

VERSION

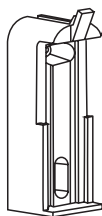

B

VERSION

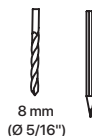
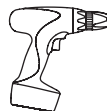

8 mm
(Ø 5/16")

* Not included

EN

A

VERSION

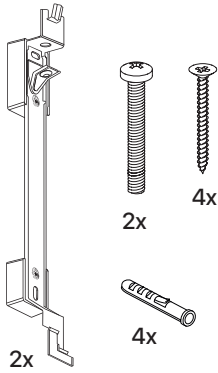

1.1

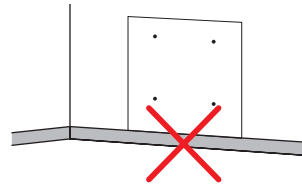
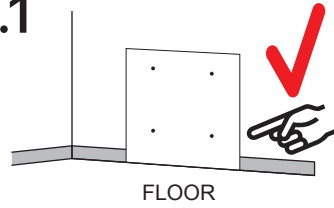

1.2

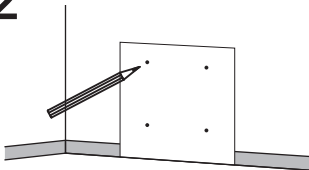

1.3

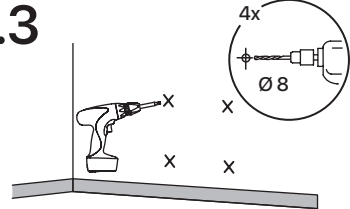

1.4

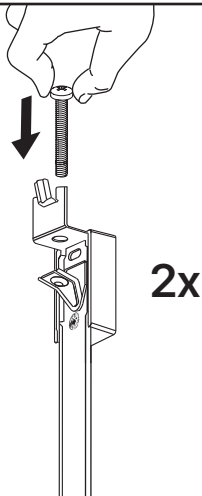

1.5

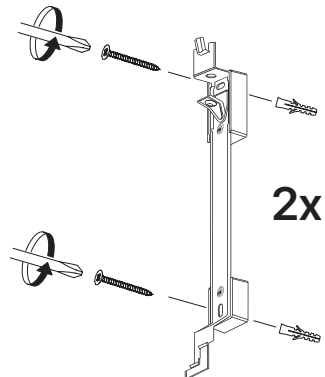

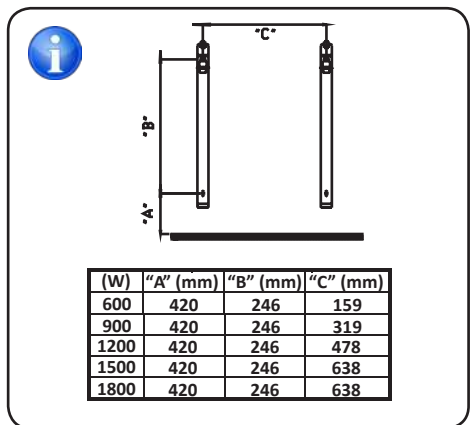
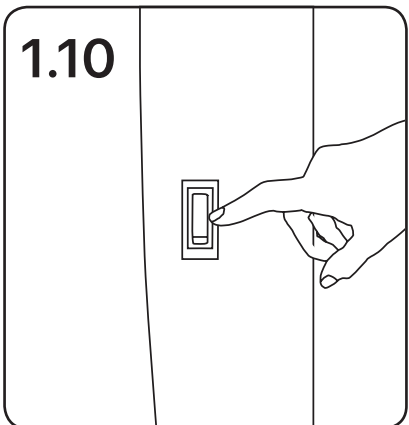
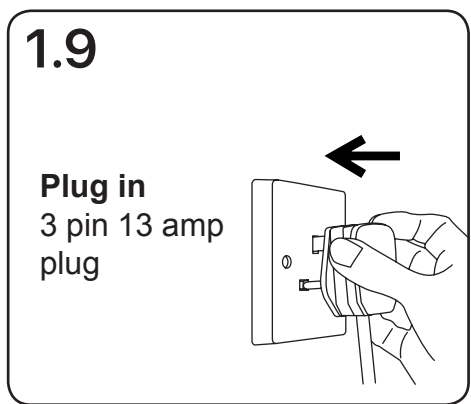
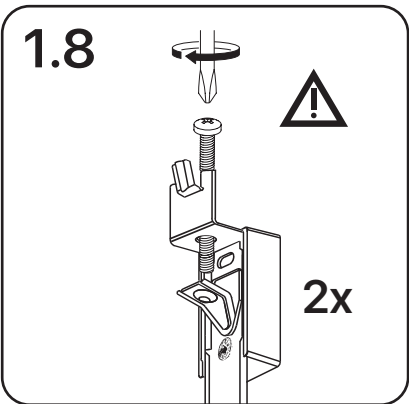
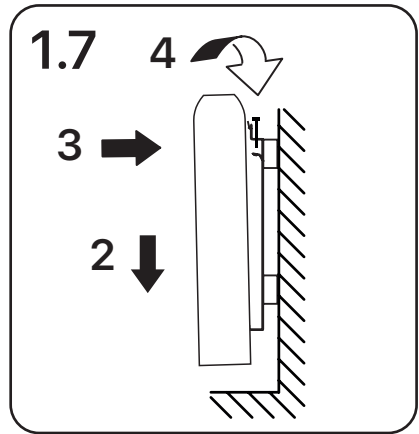
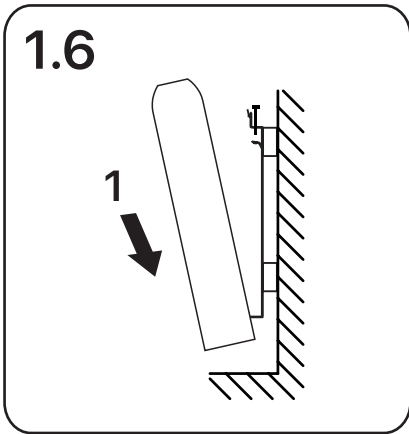

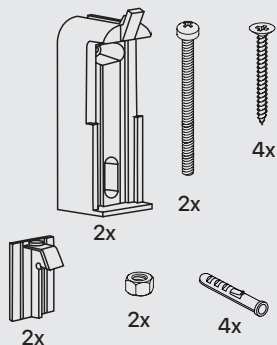
B VERSION

2.1

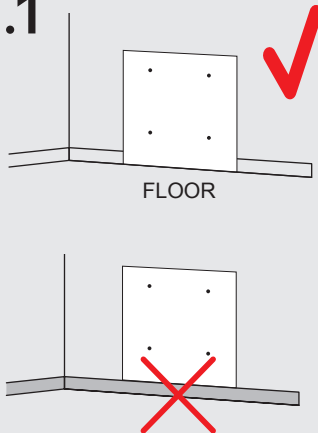

2.2

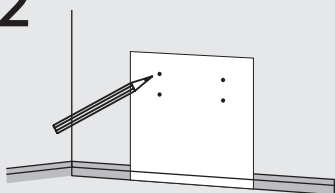

2.3

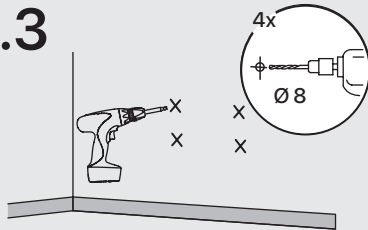

2.4

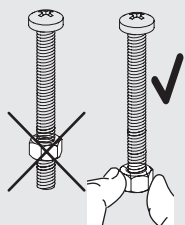

2.5

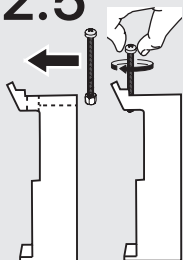

2.6

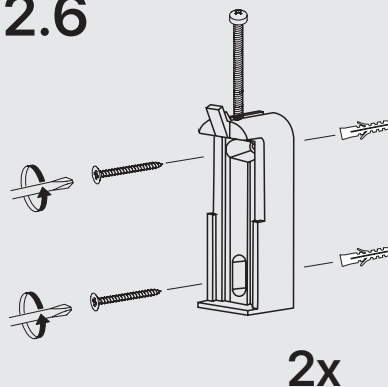

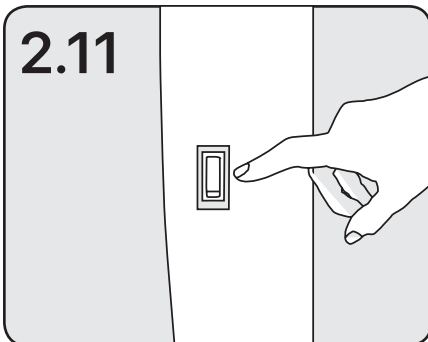
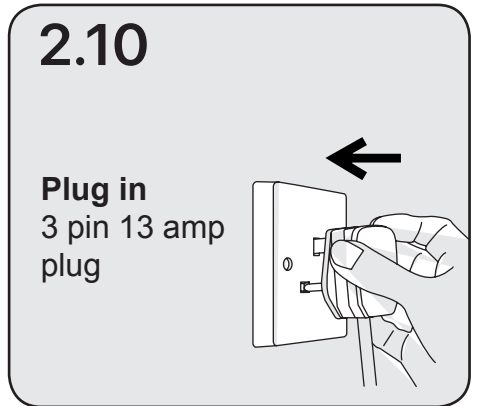
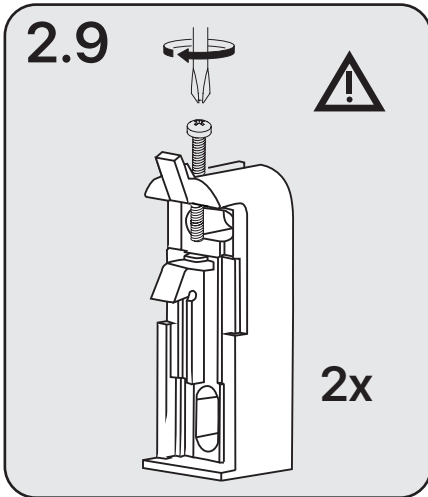
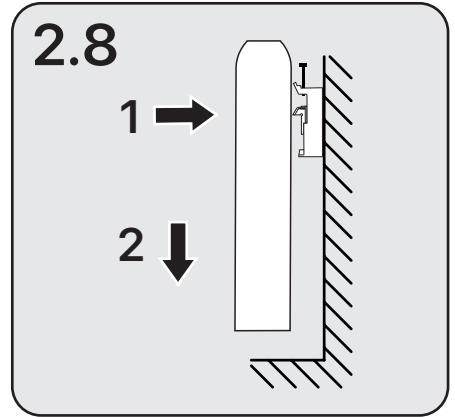
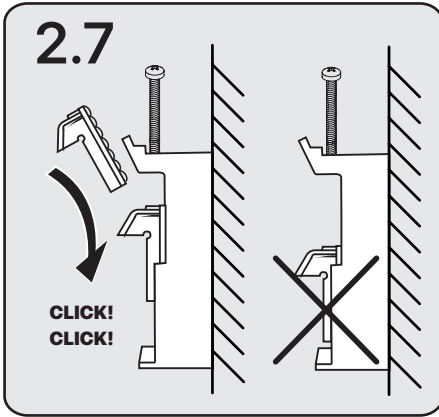

i

(W)	"A" (mm)	"B" (mm)	"C" (mm)
600	420	246	159
900	420	246	319
1200	420	246	478
1500	420	246	638
1800	420	246	638

3.1 CONTROL PANEL

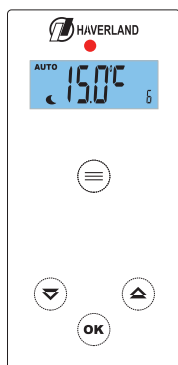

Button	Description
	AUTO / OFF / ANTI-FREEZE / MANUAL modes
	Decrease
	Increase
	Accept
	Colour indicator of the selected temperature

3.2 SCREEN DESCRIPTION

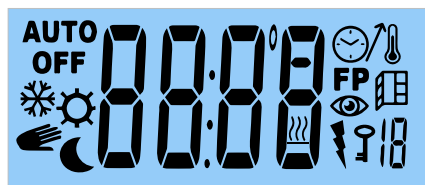

AUTO	AUTOMATIC mode indicator
	ANTI-FREEZE / COMFORT / MANUAL / ECONOMY mode indicator
OFF	OFF
	Temperature / Timer
	The radiator is heating up (the resistance is working)
	Advanced Features

3.3 START - FIRST CONNECTION

As soon as the radiator is connected to electricity, press the switch located on the right side:

- 1 All icons are shown on the screen:



- 2 Then, a second screen appears with the software version:



- 3 On the third screen:

- **If the radiator was in MANUAL / ANTI-FREEZE / OFF mode:**
 - The main screen is displayed in MANUAL / ANTI-FREEZE / OFF mode. **If you use the radiator in manual mode or in anti-frost mode, it is not necessary to set the current time and day.**
- **The radiator was in AUTO mode before the disconnection:**
 - If it is turned on of for the first time or if the radiator has been disconnected from the mains for more than 6 hours, the radiator will ask you to set the current time and day.
 - If it is not the first time or if the radiator has not been disconnected for more than 6 hours, the main screen is displayed.



If the electrical disconnection is less than 6 hours, the current time and day of the week are stored in memory; it even remembers the last operating mode.



The settings and selected temperatures are always stored in memory.

3.4 OPERATING MODES

The radiator has 4 operating modes: AUTO / OFF / ANTI-FREEZE / MANUAL. To select the operating mode, press the  button repeatedly.

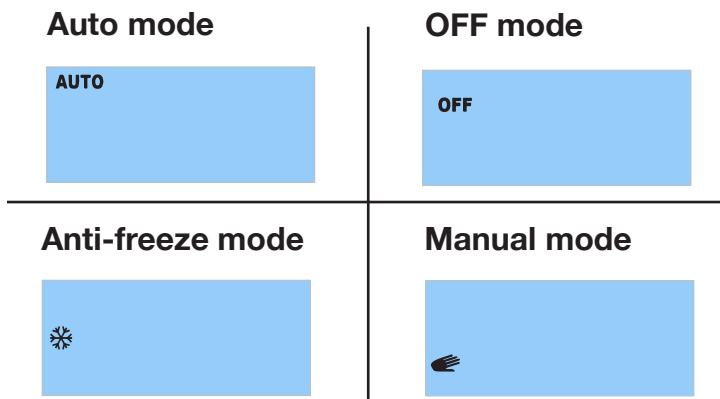

After selecting the operating mode, press the  button to confirm.

3.4.1 AUTO MODE (PROGRAMMING)

The radiator follows the settings made according to your needs and according to the temperatures selected in any operating mode.

Step 1: To select AUTO mode, press the  button repeatedly until **AUTO** appears on the screen.



IMPORTANT: While choosing AUTO mode, the current time and day are not correctly set, the radiator will ask you for the current time and day (see page 63, step 3).

Step 2: Press the  button to confirm.



The “flame” symbol will indicate that the radiator is heating; the room temperature is lower than the selected temperature. As soon as the selected temperature is reached, the symbol will disappear from the screen.



Press the  button if you want to know the room temperature.

3.4.2 OFF MODE

Step 1:

Successively press the  button until **OFF** appears on the screen.



Step 2:

Press the  button to confirm. The radiator remains off.



To switch on the radiator, press the  button successively and choose the preferred operating mode, AUTO, ANTI-FREEZE or MANUAL.

Press the  button to confirm.

3.4.3 ANTI-FREEZE MODE

The **default temperature is set to 7 °C**. This mode is used for long periods of absence in which you want to prevent the pipes from freezing.

Step 1:

Successively press the  button until  appears on the screen.



Step 2:

Press the  button to confirm.



Press the  button if you want to know the room temperature.

3.4.4 MANUAL MODE

If you do not want to set your radiator, we recommend you choose the MANUAL mode, where you can select the required temperature between 12 and 30 °C.



We recommend choosing a temperature between 20 - 21 °C.

Step 1: Successively press the  button until  appears on the screen.



Step 2: Press the  button to confirm. The pre-set temperature is displayed in manual mode.



Paso 3: Press the  or  buttons to set the target temperature. Press the  button to confirm.



The setting can be made between a minimum of 12 °C and a maximum of 30 °C.



During the selection of the requested temperature, a pilot light above the display will change colour according to the selected setpoint temperature.

- **Red** if the chosen temperature is equal to or greater than 24 °C.
- **Orange** if the chosen temperature is between 19.5 and 23.5 °C.
- **Green** if it is less than 19.5°C.



This symbol means that the radiator is heating up; the room temperature is lower than the selected temperature. As soon as the setpoint temperature is reached, the symbol will disappear from the display.



- We recommend selecting a temperature between 20 and 21 °C.
- Press the  button if you want to know the room temperature.

3.5 USER MENU



On this menu you can access and adjust the following parameters:

- **1:** CHOOSE THE COMFORT TEMPERATURE.
- **2:** CHOOSE THE ECONOMY TEMPERATURE.
- **3:** CHOOSE THE ANTI-FREEZE TEMPERATURE.
- **4:** CALIBRATE THE AMBIENT TEMPERATURE.
- **5:** SET THE DAY OF THE WEEK (**The radiator must be in AUTO mode**).
- **6:** SET THE CLOCK (**The radiator must be in AUTO mode**).
- **7:** MAKE A DAILY OR WEEKLY SCHEDULE.
- **8:** ACTIVATE OR DEACTIVATE THE “OPEN WINDOWS” FUNCTION.
- **9:** ACTIVATE OR DEACTIVATE THE “ITCS” INTELLIGENT FUNCTION.
- **10:** KNOW YOUR DAILY, WEEKLY OR MONTHLY ELECTRICITY CONSUMPTION.

3.5.1 HOW TO ACCESS THE USER MENU?

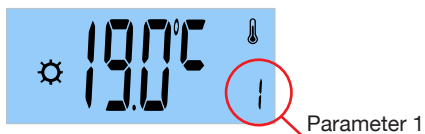
- 1** Press and hold the  button.
- 2** Horizontal stripes will appear on the screen. Next, **parameter 1, “Comfort Temperature Selection” will be displayed.**



- 3** By pressing the  or  buttons you will be able to choose, from the 10 available parameters.

**PARAMETER 1
TEMPERATURE SELECTION
COMFORT**



Press

**PARAMETER 2
SELECTION
TEMPERATURE ECONOMY**



Press

**PARAMETER 3
ANTI-FREEZE
TEMPERATURE SELECTION**



Press

**PARAMETER 4
TEMPERATURE SETTING**



Press

**PARAMETER 5
DAY WEEK SETTING (only in AUTO)**



Press

**PARAMETER 10
CONSUMPTION
INDICATOR**



Press

**PARAMETER 9
"ITCS" FUNCTION
SELECTION**



Press

**PARAMETER 8
OPEN WINDOWS
SELECTION**



Press

**PARAMETER 7
PROGRAMMATION**



Press

**PARAMETER 6
TIME SETTING (only in AUTO)**







1 PARAMETER 1: SELECT COMFORT TEMPERATURE

The radiator allows **programming day by day, hour by hour**. Each day of the week you can choose **Comfort, Economy, Anti-freeze or Off**.

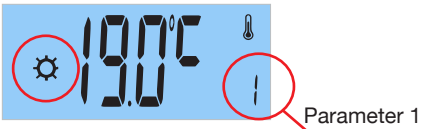
The comfort temperature is the desired temperature during the hours the room is in use.

Parameter 1 allows you to adjust the pre-set comfort temperature:

<p>Step 1: Access the user menu by pressing and holding the  button. Parameter 1 is displayed.</p>	
<p>Step 2: Press the  button to confirm.</p>	
<p>Step 3: Press the  or  buttons to choose the required comfort temperature. Press the  button to confirm.</p>	



- The comfort temperature setting can be set between 16 and 30 °C.
- We recommend choosing a comfort temperature between 20 and 21 °C.



During the selection of the required temperature, the pilot light above the display will change colour according to the selected setpoint temperature.

- **Red** if the chosen temperature is equal to or greater than 24 °C.
- **Orange** if the chosen temperature is between 19.5 and 23.5 °C.
- **Green** if it is less than 19.5°C.









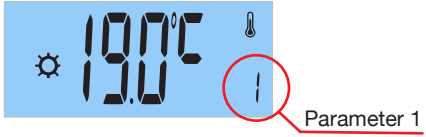

The temperatures in each operating mode are preset by default. These are the recommended temperatures for comfort, for rational electricity consumption, it is not recommended to exceed these temperatures.

2 PARAMETER 2: SELECTING THE ECONOMY TEMPERATURE

The economy temperature is the temperature that is required during the night or in the short periods of absence. Avoid excessively lowering the room temperature.

To modify the pre-set economy temperature:

<p>Step 1: Access the user menu by pressing continuously the  button. Parameter 1 is displayed.</p>	
<p>Step 2: Successively press the  or  buttons until parameter 2 is selected. Press the  buttons to confirm.</p>	
<p>Step 3: Press the  or  buttons to select the required economy temperature. Press the  buttons to confirm.</p>	



- The setting of the economy temperature can be made between 12 and 18.5 °C.
- We recommend choosing an economy temperature between 15 and 17 °C.











During the choice of the economy temperature, the pilot light above the screen will be **green**.

3 PARAMETER 3: SELECT ANTI-FREEZE TEMPERATURE

The anti-freeze temperature is the temperature that is used for long periods of absence, preventing the pipes in your home from freezing.

To modify the pre-set anti-freeze temperature:

<p>Step 1: Access the user menu by pressing and holding the  button. Parameter 1 is displayed.</p>	 <p>Parameter 1</p>
<p>Step 2: Press the  or  until parameter 3 is select. Pres the  button to confirm.</p>	 <p>Parameter 3</p>
<p>Step 3: Press the  or  buttons to choose the required anti-freeze temperature. Press the  button to confirm.</p>	



- The anti-freeze temperature can be set between 5 and 10 °C.
- We recommend choosing an anti-freeze temperature between 5 and 7 °C.















During the setting of the anti-freeze temperature, the pilot light located above the screen will be **green**.

4 PARAMETER 4: TEMPERATURE SETTING

Parameter 4 allows you to adjust the ambient temperature measured by the radiator. This calibration compensates for a possible difference between the temperature obtained in the room by an external thermostat and the temperature programmed in the radiator.

Calibration should be done after 1 day of operation and if there is a large difference between the room temperature and the ambient temperature measured by the radiator.

1. Place a precision thermometer in the room away from the radiator.
2. After one hour of heating, record the measured temperature on the thermometer.

<p>Step 1: Access the user menu by pressing the holding the  button. Parameter 1 is displayed.</p>	
<p>Step 2: Successively press the  or  buttons until parameter 4 is selected. The display alternately shows the ambient temperature in the room and the compensation value.</p> <div style="display: flex; justify-content: space-around;"> <div data-bbox="184 758 453 874">  </div> <div data-bbox="666 758 935 874">  </div> </div>	
<p>Step 3: Press the  button to confirm.</p>	
<p>Step 4: By pressing the  or  buttons, enter the previously noted temperature value. Once the temperature value has been entered, press the  buttons to confirm. The display alternately shows the new temperature and the resulting compensation value (e.g., 22 to 24 °C).</p> <div style="display: flex; justify-content: space-around;"> <div data-bbox="184 1289 453 1406">  </div> <div data-bbox="666 1289 935 1406">  </div> </div>	



The compensation range is + 5 °C / - 5 °C.





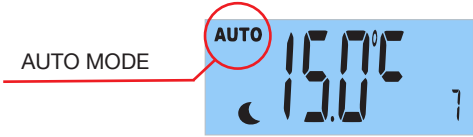













5 PARAMETER 5: SETTING DAY OF THE WEEK

 **The radiator must be in AUTO mode.**



AUTO MODE

The day of the week is automatically configured by setting the current day, month, and year.

<p>Step 1: Access the user menu by pressing and holding the  button. Parameter 1 is displayed.</p>	 <p>Parameter 1</p>
<p>Step 2: Successively press the  or  buttons until parameter 5 is selected. The display alternately shows the day, month and year. Press the  button to continue.</p>	
<p>Step 3: Press the  or  buttons select the current year. Press the  button to confirm.</p>	 <p>YEAR</p>
<p>Step 4: By pressing the  or  buttons select the current month. Press the  button to confirm.</p>	 <p>MONTH</p>
<p>Step 5: Select the current day by pressing the  or  buttons. Press the  button to confirm.</p>	 <p>DAY</p>
<p>Step 6: To finish, press the  button.</p>	

6 PARAMETER 6: TIME SETTING

















The radiator must be in AUTO mode.

AUTO MODE

AUTO





You can edit the hour and minute (24-hour time format).

<p>Step 1: Access the user menu by pressing and holding the  button. Parameter 1 is displayed.</p>	 <p>Parameter 1</p>
<p>Step 2: Successively press the  or  buttons until parameter 6 is selected. The display alternately shows the time and the minutes. Press the  button to continue.</p>	 <p>Parámetro 6</p>
<p>Step 3: Pressing the  or  buttons to select the time. Press the  button to confirm.</p>	 <p>HOUR</p>
<p>Step 4: Select the minutes by pressing a  or  buttons. Press the  button to confirm.</p>	 <p>MINUTES</p>
<p>Step 5: To finish, press the  button.</p>	

7 PARAMETER 7: PROGRAMMING

Your radiator can be operated manually or automatically (programming).

Considering your needs, feeling of comfort, orientation, and periods of stay at home, the radiator offers you the possibility of creating an individual program. **You have 3 options to program your radiator: “DAY” / “PART” / “ALL”.**

OPTIONS	PROGRAM EXPLANATION
<p>“DAY” OPTION</p> 	<p>Don't you have a daily routine? Is each day of the week different? Choose the “DAY” option to set a different programme for each day of the week. If your daily routine is different for each day of the week, we recommend this option.</p>
<p>“PART” OPTION</p> 	<p>Does your daily routine repeat itself from Monday to Friday? Is your routine the same on the weekend? Choose the option “Part” if you want a schedule from Monday to Friday and a different one for the weekend.</p>
<p>“ALL” OPTION</p> 	<p>Choose the “ALL” option if you want the same schedule for every day of the week. This option is ideal for users who have the same daily routine all week.</p>













By default, the weekly schedule set is:

- **Monday to Friday:**

The radiator works in comfort mode from 6 a.m. to 9 a.m., from 12 a.m. to 2 p.m. and from 6 p.m. to 11 p.m. The rest of the times, the radiator will be in economy mode.





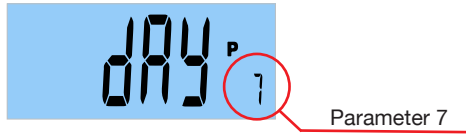

- **From Saturday to Sunday:**

The radiator works in comfort mode from 8 a.m. to 11 p.m. The rest of the times, the radiator will be in economy mode.

<p>Step 1: Access the user menu by pressing and holding the  button. Parameter 1 is displayed.</p>	
<p>Step 2: Successively press the  or  buttons until parameter 6 is selected. The display alternately shows the time and the minutes. Press the  button to continue.</p>	
<p>Step 3: By pressing the  or  buttons and according to the table above, select one of the three options to program your radiator.</p> <p>Press the  button to confirm the required option.</p>	
<p>Step 4:</p> <ul style="list-style-type: none"> • If you have chosen the “DAY” option, continue on page 62. • If you have chosen the “PART” option, continue on page 65. • If you have chosen the “ALL” option, continue on page 68. 	

7.1 If you have chosen the programming option “dAY”:

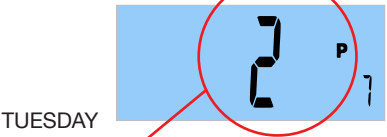

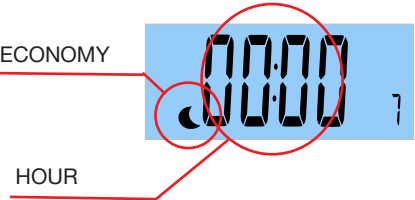
<p>Step 5: Press the  button to start configuring this option. Day 1 appears (1 = Monday). Programming begins the first day of the week and at 00 h.</p>	 <p>The LCD display shows 'MONDAY P'. The digit '1' is circled in red, and a red line points from the label 'MONDAY' to it.</p>
<p>Step 6: To move from one day to the next, press the  or  :</p> <p>1 = Monday, 2 = Tuesday, 3 = Wednesday, 4 = Thursday, 5 = Friday, 6 = Saturday, 7 = Sunday</p>	 <p>The LCD display shows 'TUESDAY P'. The digit '2' is circled in red, and a red line points from the label 'TUESDAY' to it.</p>
<p>Step 7: Once you have chosen the day of the week, press  to confirm.</p> <p>The display shows 00 h (midnight) of the chosen day of the week and ECONOMY mode.</p> <p>Then select hour-by-hour operation mode:</p>	 <p>The LCD display shows 'ECONOMY P' and '00:00'. The '00:00' is circled in red, and a red line points from the label 'HOUR' to it.</p>

Step 8: In the first time zone, 00 h to 01 h, press  button successively to select the operating mode: comfort, OFF, anti-freeze or economy. What operating mode to choose?



COMFORT MODE

Select **COMFORT Mode** if the room is occupied during the time slot.

In this mode, the radiator will work according to the comfort temperature chosen in **parameter 1**.

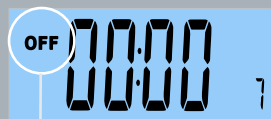

OFF MODE

Select **OFF Mode** if you do not need heating in the room during the time slot.



ANTI-FREEZE MODE

The **ANTI-FREEZE Mode** is usually used for long periods of absence in which you want to avoid problems of freezing pipes.

In this mode, the radiator will operate according to the anti-freeze temperature selected in **parameter 3**.



ECONOMY MODE

The **ECONOMY mode** is used at night or in short periods of absence. Prevent the ambient temperature from dropping excessively.

In this mode, the radiator will operate according to the comfort temperature chosen in **parameter 2**.

Step 9: Once you have chosen the operating mode for the time slot from 00:00 to 01: 00h, press the  button to configure the next time slot. Repeat this process hour by hour.



Press the  or  buttons to scroll through each time slot.

Step 10: In the last time slot of the day, **END** appears on the screen.



Step 11: To confirm the programming, press the



ok button.



Step 12: To exit the programming menu, press the  button.

Once the time program has been set, the radiator will follow the set program **as long as the chosen operating mode is AUTO mode.**











Press the  button twice to exit the programming menu, **WITHOUT SAVING THE DATA.**

7.2 If you have chosen the programming option “PART”:





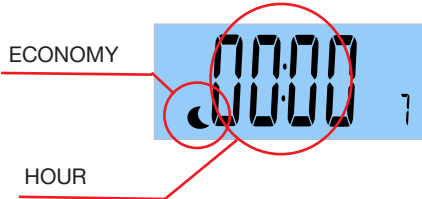









You can configure two periods: from Monday to Friday and Saturday to Sunday.

The programming carried out on Monday will be repeated until Friday and the programming carried out on Saturday will be repeated on Sunday.

<p>Step 5: Press the  button to start configuring this option. The display shows 1 - 5 (Monday to Friday).</p>	
<p>Step 6: Press the  or  buttons to choose the period from Monday to Friday (1-5) or the period from Saturday to Sunday (6-7).</p> <div style="display: flex; justify-content: space-around; align-items: center;">   </div>	
<p>Step 7: Once you have chosen the day of the week, press  to confirm. The display shows 00 h (midnight) on the first day of the chosen period and also, ECONOMY mode.</p> <div style="text-align: center;">  <p style="margin-left: 20px;">ECONOMY</p> <p style="margin-left: 20px;">HOUR</p> </div>	
<p>Step 8: For the first time slot from 00:00 to 01:00 on Monday, successively press the  button to choose the required operating mode: Comfort, OFF, Anti-freeze or Economy.</p>	
<p>Step 9: Once you have chosen the operating mode for the time slot from 00 h to 01 h, press the  button to move to the next time slot. Repeat this process for each time slot.</p>	

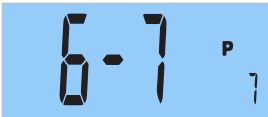

Press the  or  buttons to scroll through each time slot.

<p>Step 10: In the last time slot of the day, END appears on the screen.</p>	
<p>Step 11: Press the  button. The program carried out on Monday will be repeated until Friday.</p>	
<p>Step 12: To start programming the time slot from Saturday to Sunday, press the  button.</p>	
<p>Step 13: Press the  or  buttons to choose the PART option again.</p>	
<p>Step 14: Press the  button. 1 - 5 (Monday to Friday) is displayed.</p>	
<p>Step 15: Press the  or  buttons to select the time slot from Saturday to Sunday (6-7).</p>	

Step 16: Press  button to confirm. The display shows **00 h (midnight) on Saturday** and also, **ECONOMY** mode.

ECONOMY



HOUR

Step 17: For the first time slot from 00:00 to 01:00 on Monday, successively press the  button to choose the required operating mode: comfort, OFF, anti-freeze or economy.

Step 18: Once you have chosen the operating mode for the time slot from 00 h to 01 h, press the



to move to the next time slot. Repeat this process for each time slot.

Step 19: In the last time slot of the day, **END** appears on the screen.



Step 20: To exit the programming menu, press the  button. The program carried out on Saturday will also be repeated on Sunday.



Press the



button twice to exit the programming menu, **WITHOUT SAVING THE DATA.**

7.3 If you have chosen the programming option “ALL”:



You can configure the same program from Monday to Sunday. The programming that takes place on Monday, will be repeated until Sunday.

Step 16: Press **OK** to confirm. The display shows **00 h (midnight) on Saturday and also, ECONOMY mode.**

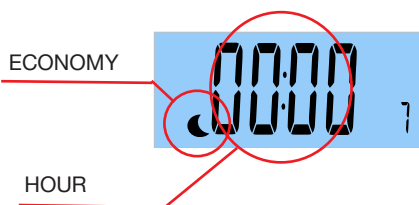

Step 17: For the first time slot from 00:00 to 01:00 on Monday, successively press the **OK** button to choose the required operating mode: comfort, OFF, anti-frost or economy.

Step 18: Once you have chosen the operating mode for the time slot from 00 h to 01 h, press the



button to move to the next time slot. Repeat this process for each time slot.

Step 19: In the last time slot of the day, **END** appears on the screen.



Step 20: To exit the programming menu, press the **OK** button. The program carried out on Monday will be repeated until Sunday.

Once the programme is configured, the radiator will follow it **as long as the chosen operating mode is AUTO mode.**





Press the  button twice to exit the programming menu, **WITHOUT SAVING THE DATA.**



IMPORTANT: Temporary modification of a program in progress

This function allows you to modify the setpoint temperature temporarily until the next programmed temperature change or when more than 2 hours have elapsed since the modification.

Step 1: While the radiator is in Auto mode, press the  or  buttons to temporarily modify the setpoint temperature.

Step 2: Press  to confirm.

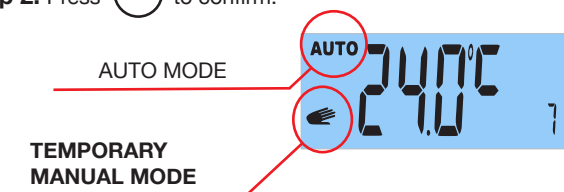

This modification will be automatically cancelled at the next programme change or when more than 2 hours have elapsed since the modification.













IMPORTANT:

- The radiator will operate accordingly to the operating mode (Comfort / Economy / Anti-frost / OFF) that we see on the screen.
- Do not forget that the radiator must be in AUTO mode for the configured programming to be fulfilled.
- You can always modify the temperatures assigned for comfort, economy, or anti-freeze mode, modifying parameter 1, parameter 2 or parameter 3, respectively.
- The temperature shown on the display is the temperature set in the current operating mode.
- The  symbol will appear whenever the resistance of the device is running.

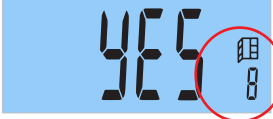
8 PARAMETER 8: "OPEN WINDOWS" SAVING FUNCTION

This function is activated when there is a sudden drop in the temperature in the room. When the window is closed, the radiator will detect a rise in temperature and the radiator will heat up again, returning to the state before it was switched off.

This intelligent function is activated as standard. It can be disabled if you wish.

<p>Step 1: Access the user menu by pressing and holding the  button. Parameter 1 is displayed.</p>	
<p>Step 2: Successively press the  or  button until parameter 8 is selected. Press the  button to confirm.</p>	
<p>Step 3: Press the  or  button to activate or deactivate the function. Press the  button to confirm.</p> <div style="display: flex; justify-content: space-around; align-items: center;"> <div data-bbox="241 938 510 1056">  <p>Function Enabled</p> </div> <div data-bbox="609 938 878 1056">  <p>Function Disabled</p> </div> </div>	
<p>Step 4: To exit the programming menu, press the  button.</p>	













Press the  button twice to exit the programming menu, **WITHOUT SAVING THE DATA**

9 PARAMETER 9: INTELLIGENT FUNCTION "ITCS"

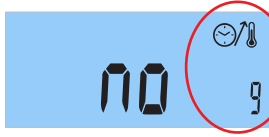
The radiator incorporates an **innovative ITCS smart temperature control system**.

This system activates the start-up of the machine in **advance of the programmed time** (2 hours maximum), to ensure that the required temperature is achieved at the indicated time and following the established weekly program.

This intelligent function is activated as standard. It can be deactivated if you wish.

<p>Step 1: Access the user menu by pressing and holding the  button. Parameter 1 is displayed.</p>	
<p>Step 2: Successively press the  or  until parameter 9 is selected. The display alternately shows the time and the minutes.</p> <p>Press the  to confirm.</p>	
<p>Step 3: To activate or deactivate the function, press the  or  buttons. Press  to confirm.</p> <div style="display: flex; justify-content: space-around; align-items: center;"> <div data-bbox="224 949 492 1125" style="text-align: center;">  <p>Function Disabled</p> </div> <div data-bbox="588 949 856 1125" style="text-align: center;">  <p>Function Enabled</p> </div> </div>	
<p>Step 4: To exit the programming menu, press the  button.</p>	















Press the  button twice to exit the programming menu, **WITHOUT SAVING THE DATA**

10 PARAMETER 10: "CONSUMPTION INDICATOR" FUNCTION

The radiator incorporates a unique function on the market that allows you to know your electricity consumption in the last 24 hours, the last 7 days, and the last 30 days.



- **Important: Before knowing the electricity consumption, you must enter the power value of your radiator (see page 77).**
- **The radiator saves the consumption data every 4 hours.**



<p>Step 1: Access the user menu by pressing and holding the  button. Parameter 1 is displayed.</p>	 <p>Parameter 1</p>
<p>Step 2: Successively press the  or  buttons until parameter 10 is selected. Press the  button to confirm.</p>	 <p>Parameter 10</p>
<p>The screen alternately shows the consumption (in kWh) during the last 24 hours:</p> <p>Consumption in kWh</p>  	
<p>Step 3: Successively press the  or  buttons to know the electricity consumption during the last 7 days and the last 30 days.</p>  	
<p>Step 4: To exit the menu, press twice .</p>	



In the option "consumption last 24 hours" you can know the total consumption of the radiator from the first day of operation by continuously pressing the  button.



11 PARAMETER 11: END

<p>Step 1: You have reached the end of the user menu.</p>	
<p>Step 2: Press the  button to exit the user menu.</p>	

3.6 ADVANCED MENU

With the advanced menu you can access and adjust the following parameters:

- **1:** SELECTION OF DEGREES CELSIUS °C or FARENHEIT °F.
- **2:** ACTIVATE or DEACTIVATE THE “FIL PILOTE” FUNCTION (for France). It requires a switchboard (not included).
- **3:** SOFTWARE VERSION INDICATION.
- **4:** RADIATOR POWER VALUE ADJUSTMENT.
- **5:** RESET FUNCTION.
- **6:** ADVANCED MENU END.

3.6.1 HOW TO ACCESS THE ADVANCED MENU?

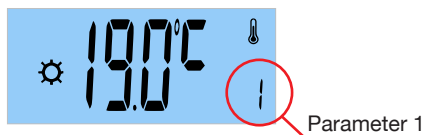

Step 1: Press and hold the  button. Horizontal stripes will appear on the screen and then parameter 1, “Comfort Temperature Selection” will be displayed.



Step 2: Successively press the  or  buttons until **parameter 11 “END” is selected.**



Step 3: Press and hold the  Horizontal stripes will appear on the screen. Next, **parameter 1 will be displayed, “CHOICE OF DEGREES CELSIUS °C / FARENHEIT °F”.**

Step 4: Press the  or  buttons to select the advanced parameter to be modified.

**PARAMETER 1
SELECTION °C or °F**

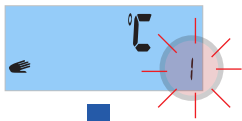

**PARAMETER 2
"FIL PILOTE" SELECTION
(only for France)**



**PARAMETER 3
SOFTWARE VERSION**



**PARAMETER 6
ADVANCED END MENU**



**PARAMETER 5
"RESET" FUNCTION**











**PARAMETER 4
RADIATOR POWER
SELECTION**













1 PARAMETER 1: SELECT CELSIUS / FARENHEIT DEGREES

Select degrees Celsius (°C) or degrees Fahrenheit (°F).

<p>Step 1: Access the advanced menu.</p>	
<p>Step 2: Press the  button to confirm.</p>	
<p>Step 3: Press the  or  buttons to choose °C or °F. Press the  button to confirm.</p>	
<p>Step 4: Press the  or  buttons to select another advanced parameter or press the  button to exit the advanced menu.</p>	





2 PARAMETER 2: "FIL PILOT" FUNCTION SELECTION (only for France and requires a switchboard not included)

This function is only operational in France. To enable or disable this function, follow these steps:

<p>Step 1: Access the advanced menu. Using the  or  select 2.</p>	
<p>Step 2: Press the  button to confirm.</p>	
<p>Step 3: Press the  or  buttons to choose Yes or No. Press the  button to confirm.</p>	
<p>Step 4: Press the  or  buttons to select another advanced parameter or press  button to exit the advanced menu.</p>	

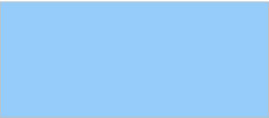
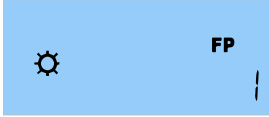





The “Fil Pilote” function works only in **MANUAL** mode.

Once the temperature has been chosen in manual mode, the different “Fil Pilote” commands behave as follows:

“FIL PILOTE” ORDER	SCREEN
Comfort (There is no order)	
Comfort - 1°	
Comfort - 2°	
Economy	
Anti-freeze	
OFF	











3 PARAMETER 3: SOFTWARE VERSION

Indicates the current version of your radiator software.

<p>Step 1: Access the advanced menu. Using the  or  buttons select 3.</p>	
<p>Step 2: The software version of your radiator is displayed.</p>	
<p>Step 3: Press the  or  to select another advanced parameter or press the  button to exit the advanced menu.</p>	

4 PARAMETER 4: SELECT RADIATOR POWER





For parameter 10 “consumption indicator” to work correctly you must enter the value of the power of your radiator. **The power (watts) is indicated on the gray label located on the right side of the radiator next to the power cable.**

<p>Step 1: Access the advanced menu. Using the  or  buttons select 4.</p>	
<p>Step 2: Press the  button to confirm.</p>	
<p>Step 3: Press the  or  buttons to select the power of your radiator (for example 1000 W). Press the  button to confirm.</p>	
<p>Step 4: Press the  or  buttons to select another advanced parameter or press the  button to exit the advanced menu.</p>	



5 PARAMETER 5: "RESET"

This parameter allows us to:



- **Clear radiator programming.**
- **Clear all parameters, except the power of your radiator (Advanced parameter 4, page 77).**

<p>Step 1: Access the advanced menu. Using the  or  buttons select 5.</p>	
<p>Step 2: To reset the radiator to factory defaults, press and hold the  button.</p>	
<p>Step 3: The "reset" process of your radiator will begin.</p> <p>Once the "reset" process has been completed, the radiator will return to manual mode with the factory pre-set temperature (20 °C).</p> <p>Then, choose the required operating mode. If you choose AUTO mode, you will need to set the current time and day. Reprogram your radiator and set the parameters you want.</p>	

6 PARAMETER 6: END

<p>Step 1: You have reached the end of the advanced menu.</p>	
<p>Step 2: Press the  or  buttons to exit the advanced menu.</p>	

3.7 “KEYBOARD LOCK” FUNCTION

Press the  and  buttons simultaneously until a KEY symbol appears on the screen.



Repeat the same operation to unlock the keyboard until the KEY symbol disappears.



If there is a power failure while the “key lock” function is activated, the radiator will continue with “key lock” activated.

3.8 ERROR MESSAGE “ERR”

If the message “Err” is flashing on the screen, your thermostat sensor has been disconnected or faulty. Consult with our Haverland After-Sales Service.



4. MAINTENANCE

Your device does not require any type of special maintenance.

You need only clean any dust that may accumulate with a dry and soft cloth.

We advise that you clean any accumulated dust from the radiator surface at the beginning of the winter season.



NEVER USE SOLVENTS OR ABRASIVE PRODUCTS.

- **Veillez lire les instructions explicatives.**
- Pour déconnecter le radiateur du réseau électrique, retirez le câble d'alimentation de la prise de courant. **Ne jamais tirer du câble électrique.**
- Ne pas laisser le câble de connexion en contact avec l'appareil pendant qu'il est allumé.
- **La garantie de l'appareil ne tiendra pas en compte des dommages causés par la non lecture de ces instructions.**



DANGER: NE PAS COUVRIR L'APPAREIL. NE PAS L'UTILISER POUR SÉCHER LE LINGE.
Le couvrir occasionnerait un danger, car il pourrait se produire une surchauffe.



• **DANGER:** Si le câble d'alimentation s'abîme il faudra le faire remplacer par un Service Technique Autorisé afin d'éviter un risque quelconque.



• **DANGER:** Si l'appareil va être installé dans une salle de bain, il doit être placé de telle sorte que l'appareil ne puisse pas être touché par n'importe quelle personne qui se trouve dans la baignoire ou la douche.



• **L'installation doit être effectuée selon les instructions du fabricant et conformément à la législation électrique en vigueur.**

• L'appareil ne doit pas être placé en dessous ou devant une prise de courant.

• Pendant son fonctionnement, il faudra prendre la précaution de maintenir éloigné l'appareil de matériaux combustibles tels que rideaux, moquettes, meubles, etc.

• L'installation doit être effectuée selon la législation électrique en vigueur.

• Cet appareil doit être connecté à une prise de terre.

• Le radiateur doit être installé de telle manière que le câble électrique d'alimentation soit parfaitement accessible.

• **Cet radiateur est un appareil qui doit être fixé au mur. Ce radiateur ne doit pas être encastré. Respectez toujours les distances de**

sécurité.

• **Pour éviter que les enfants ne puissent modifier la programmation de l'émetteur, ce-lui-ci dispose d'un blocage.**

• Cet appareil n'est pas conçu pour être utilisé par des personnes (y compris les enfants) ayant des capacités physiques, sensorielles ou mentales réduites, avec peu d'expérience ou de connaissance, à moins qu'elles ne soient sous la supervision d'une personne responsable de leur sécurité, avec les instructions d'usage de l'appareil. Les enfants doivent être supervisés pour s'assurer qu'ils ne jouent pas avec l'appareil.

• Les enfants âgés de moins de 3 ans doivent se maintenir hors de portée de l'appareil, à moins qu'ils ne soient continuellement supervisés.

• Les enfants de 3 ans à 8 ans peuvent allumer / éteindre l'appareil, seulement si celui-ci a été placé ou installé dans sa position de fonctionnement normal prévue, et s'ils sont supervisés ou qu'ils ont reçu des instructions relatives à l'usage de l'appareil de façon sûre, et aient les risques que renferme l'appareil.

• Les enfants de 3 ans à 8 ans ne doivent pas brancher, ni régler, ni nettoyer l'appareil ni réaliser des opérations de maintenance.

• Cet appareil peut être utilisé par les enfants à partir de 8 ans et les personnes avec capacités physiques, sensorielles ou mentales réduites avec peu d'expérience et de connaissance, si elles ont reçu la supervision ou la formation convenable en ce qui concerne l'utilisation de l'appareil de façon sûre et qu'elles comprennent les dangers qu'il implique. Le nettoyage et la maintenance à réaliser par l'utilisateur ne doivent pas être effectués par des enfants. Les enfants ne doivent pas jouer avec l'appareil.



• **PRÉCAUTION : Certaines parties de ce produit peuvent devenir très chaudes et provoquer des brûlures.**

• Avant chaque saison hivernale, ou si l'appareil a été débranché pendant plusieurs jours, nettoyez l'appareil avant de le connecter (suivez les étapes "section Maintenance"). Avec ledit nettoyage, vous éviterez de faire brûler la poussière accumulée et autres restes.

- Il est normal que, lors du premier démarrage, l'appareil puisse dégager une odeur. Faites fonctionner votre émetteur dans un lieu ventilé pendant 2 ou 3 heures.
- Il faudra y accorder une attention particulière lorsque des enfants et/ou des personnes vulnérables seront présents.
- Évitez de toucher les parties externes de l'émetteur pendant son fonctionnement.
- Le radiateur **NE peut pas fonctionner** avec des centrales externes de programmation ou tout autre dispositif de contrôle extérieur.
- **PRÉCAUTION** : Pour éviter tout danger d'asphyxie, gardez ce sac en plastique hors de portée des bébés et des enfants.
- L'effet de la convection, conjointement avec d'autres facteurs environnementaux, peut provoquer une décoloration dans les surfaces métalliques et plastiques.
- Les contrastes de température peuvent générer "des craquements" ou des bruits dans l'appareil. Ceci n'est pas une défaillance du radiateur.
- Au moment de jeter les radiateurs, il faudra tenir compte des exigences requises par la législation pour le traitement et recyclage des résidus.

**IMPORTANT**

- Il est indispensable **FIXER FERMEMENT le radiateur A UN MUR SOLIDE ET NIVELÉ.**
- Vérifier qu'il y a une prise de courant proche de l'endroit où vous souhaitez le situer.
- Prenez de l'intérieur de la boîte d'emballage le patron qui indique la position exacte.
- Pour éviter des problèmes, la distance minimum de 15 cm est nécessaire entre le radiateur et tout autres matériaux.

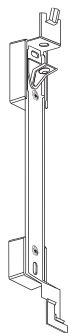
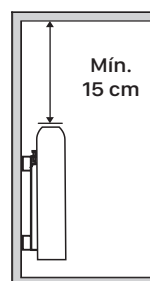
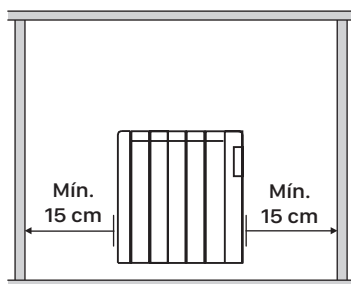

A
VERSION

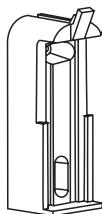

B
VERSION

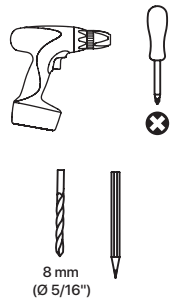

* Non inclus

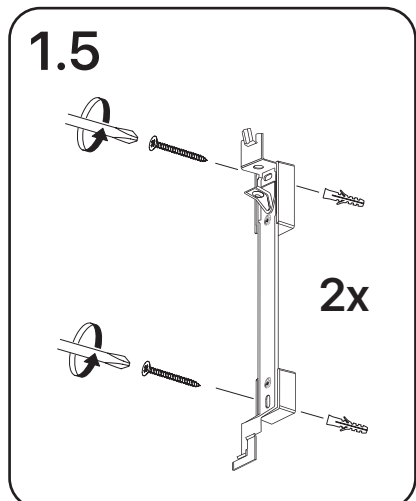
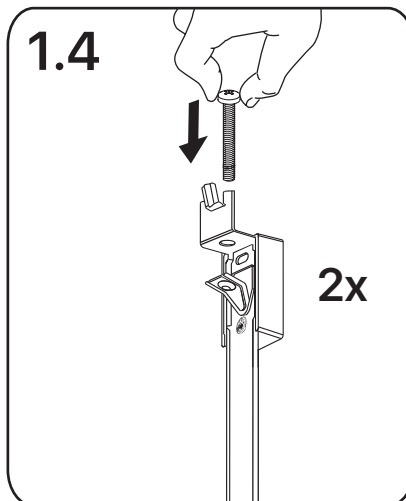
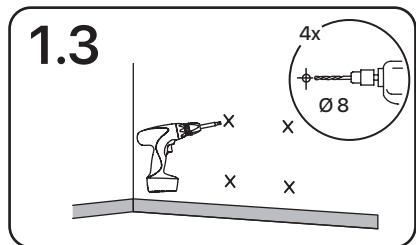
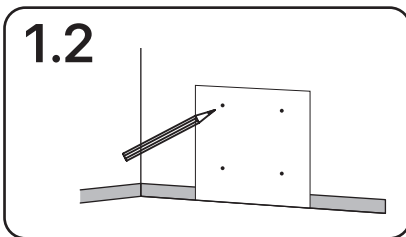
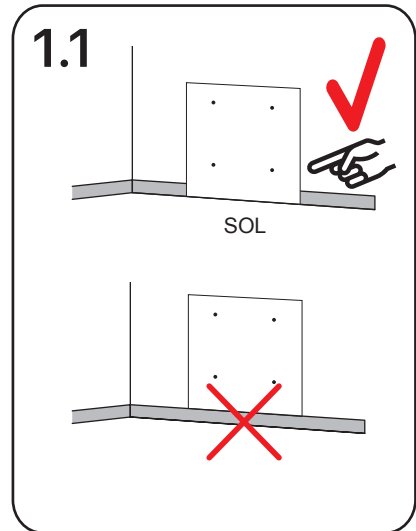
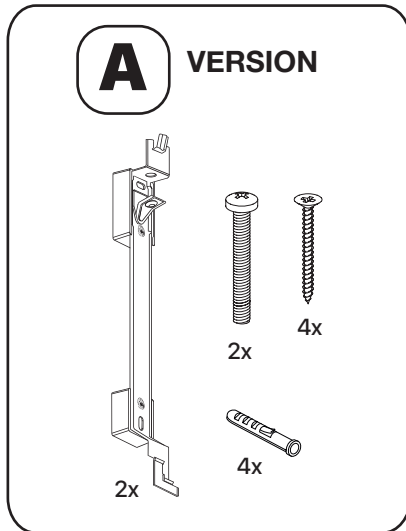

1.6

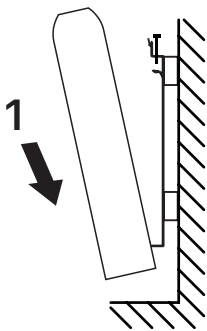

1.7

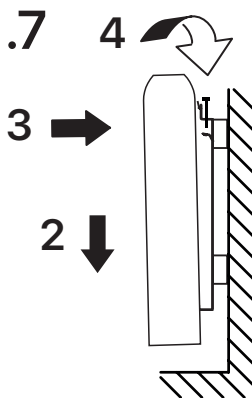

1.8

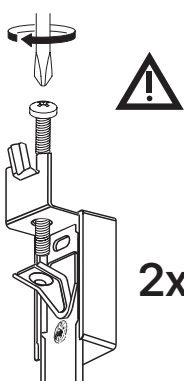

1.9

Cordon de l'appareil

RÉSEAU 230 V

Bleu ou Gris

Marron

Terre (Vert et jaune)

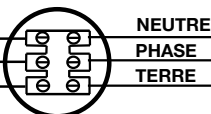

1.10

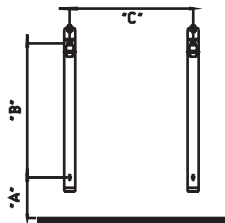
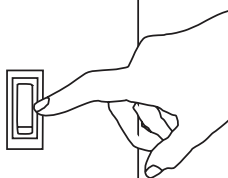

(W)	"A" (mm)	"B" (mm)	"C" (mm)
600	420	246	159
900	420	246	319
1200	420	246	478
1500	420	246	638
1800	420	246	638

B VERSION

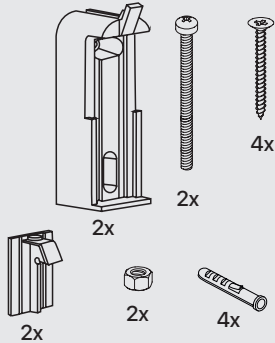

2.1

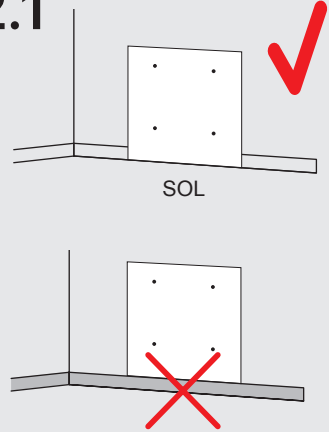

2.2

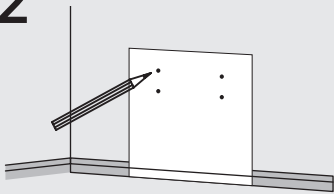

2.3

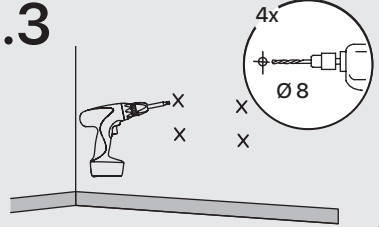

2.4

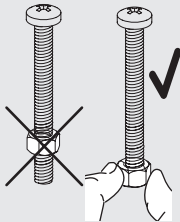

2.5

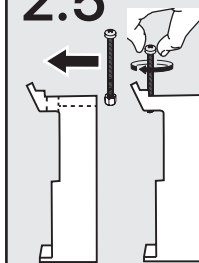

2.6

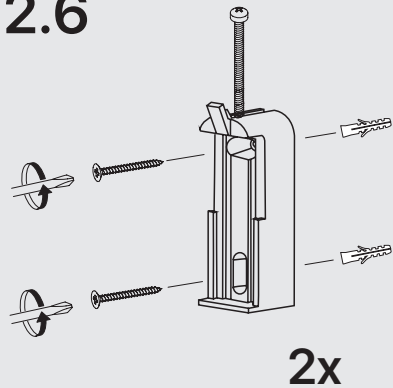

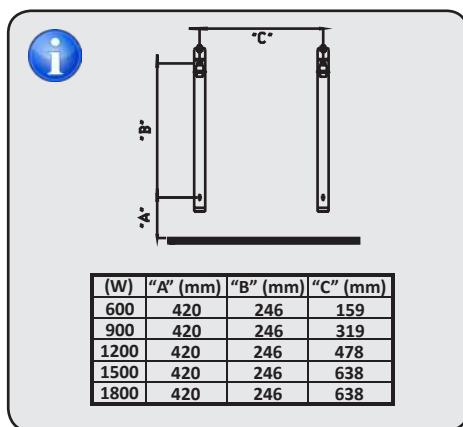
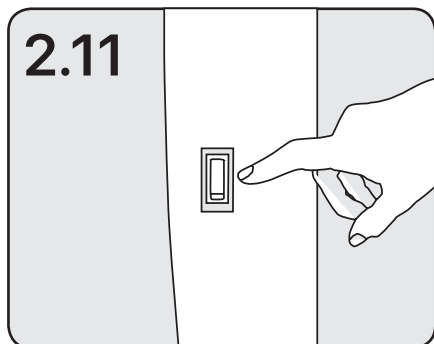
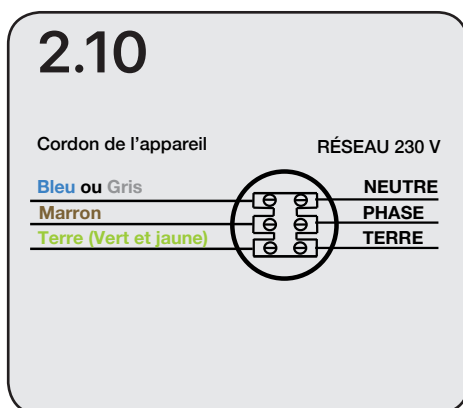
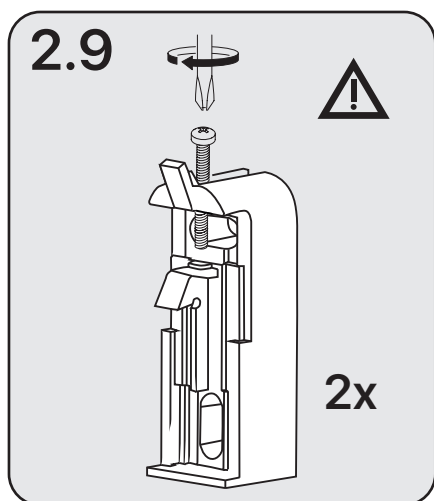
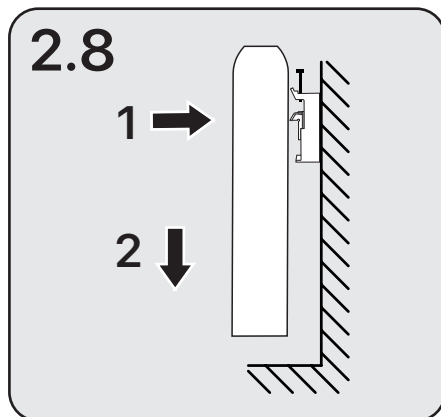
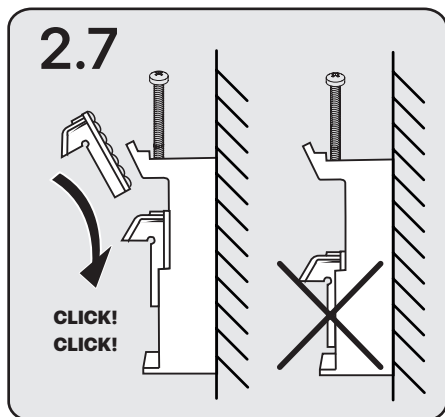

3.1 PANNEAU DE COMMANDE

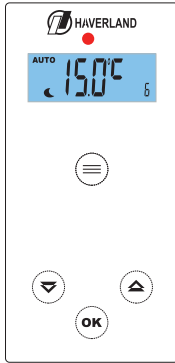

Touche	Description
	Modes AUTO / OFF / ANTIGEL / MANUEL
	Diminuer
	Augmenter
	Valider
	Indicateur de couleur de la température sélectionnée

3.2 AFFICHAGE



AUTO	Indicateur du mode AUTOMATIQUE
	Indicateur du mode ANTIGEL / CONFORT / MANUEL / ECONOMIE
OFF	Éteint/OFF
	Température / Minuteur
	Indicateur de résistance connectée
	Fonctions avancées

3.3 DÉMARRAGE - PREMIER BRANCHEMENT

Dès que le radiateur est raccordé au réseau et que l'on appuie sur l'interrupteur, situé sur le côté droit :

- 1 Toutes les icônes s'affichent à l'écran :



- 2 Puis un deuxième écran apparaît avec la version du logiciel :



- 3 Sur le troisième écran :

- **Si le radiateur était en mode MANUEL / ANTIGEL / OFF :**
 - L'écran principal s'affiche en mode MANUEL / ANTIGEL / OFF. **Si vous utilisez le radiateur en mode manuel ou en mode antigel, il ne sera pas nécessaire de régler l'heure et le jour actuel.**
- **Si avant de le débrancher, il était en mode AUTO :**
 - Si c'est la première fois ou **si le radiateur a été débranché du réseau électrique pendant plus de 6 heures, le radiateur vous demandera de régler l'heure et le jour en cours.**
 - Si ce n'est pas la première fois ou si le radiateur n'a pas été débranché depuis plus de 6 heures, l'écran principal s'affiche.



Si la durée du débranchement électrique est inférieure à 6 heures, l'heure et le jour de la semaine actuels seront mémorisés ; L'appareil se souviendra également du dernier mode de fonctionnement.



La programmation et les températures sélectionnées sont toujours gardées en mémoire.

3.4 MODES DE FONCTIONNEMENT

Le radiateur dispose de 4 modes de fonctionnement : **AUTO** / **OFF** / **HORS-GEL** / **MANUEL**. Pour sélectionner le mode de fonctionnement, appuyez successivement sur la touche .

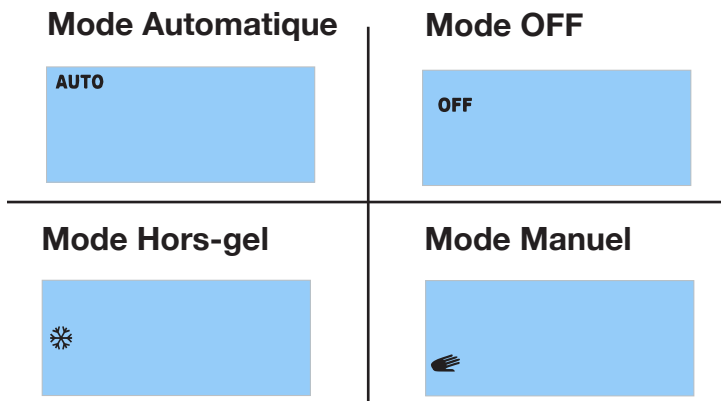

Après avoir sélectionné le mode de fonctionnement, appuyez sur la touche  pour confirmer.

3.4.1 MODE AUTO (PROGRAMMATION)

Le radiateur suit la programmation effectuée selon vos besoins et selon les températures sélectionnées dans n'importe quel mode de fonctionnement.

Étape 1: Pour sélectionner le mode AUTO, appuyez successivement sur la touche  jusqu'à ce que **AUTO** s'affiche à l'écran.



IMPORTANT : Si lorsque vous sélectionnez le mode AUTO, l'heure et le jour en cours ne sont pas correctement configurés, le radiateur vous demandera l'heure et le jour (voir page 104, étape 3).

Étape 2: Appuyez sur la touche .



Le symbole "flamme" indique que le radiateur chauffe ; la température ambiante est inférieure à la température sélectionnée. Dès que la température sélectionnée est atteinte, le symbole disparaît de l'écran.



Appuyez sur la touche  si vous voulez connaître la température ambiante

3.4.2 MODE OFF

Étape 1:

Appuyez successivement sur la touche  jusqu'à ce que **OFF** s'affiche à l'écran.



Étape 2:

Appuyez sur la touche  pour confirmer. Le radiateur reste éteint.



Pour allumer le radiateur, appuyez successivement sur la  et sélectionnez le mode de fonctionnement souhaité, AUTO, ANTIGEL ou MANUEL.

Appuyez sur la touche  pour confirmer.

3.4.3 MODE HORS-GEL

La température réglée en usine est de 7 °C. Ce mode est utilisé pour les longues périodes d'absence pendant lesquelles vous souhaitez éviter que les tuyaux ne gèlent.

Étape 1:

Appuyez successivement sur la touche  jusqu'à ce que  s'affiche à l'écran.



Étape 2:

Appuyez sur la touche  pour confirmer.



Appuyez sur la touche  si vous souhaitez connaître la température ambiante.

3.4.4 MODE MANUEL

Si vous ne souhaitez pas programmer votre radiateur, nous vous recommandons de sélectionner le mode MANUEL, dans lequel vous pouvez sélectionner la température souhaitée entre 12 et 30 °C.

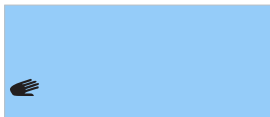

Nous vous recommandons de choisir une température comprise entre 20 et 21 °C.

Étape 1: Appuyez successivement sur la touche  jusqu'à ce que  s'affiche à l'écran.



Étape 2: Appuyez sur la touche  pour confirmer. La température pré-réglée est affichée en mode manuel.



Étape 3: Appuyez sur la touche  ou  pour régler la température souhaitée. Appuyez sur la touche  pour confirmer.



 Le réglage peut être effectué entre un minimum de 12 °C et un maximum de 30 °C.

 Lorsque vous sélectionnez la température souhaitée, un voyant situé au-dessus de l'écran changera de couleur en fonction de la température de consigne choisie.

- **Rouge** si la température choisie est égale ou supérieure à 24 °C.
- **Orange** si la température choisie est comprise entre 19,5 et 23,5 °C.
- **Vert** si la température est inférieure à 19,5°C.



Ce symbole vous indiquera que le radiateur chauffe ; la température ambiante est inférieure à la température sélectionnée. Dès que la température de consigne est atteinte, le symbole disparaît de l'écran.



- Nous vous recommandons de choisir une température comprise entre 20 et 21 °C.
- Appuyez sur  si vous voulez connaître la température ambiante.

3.5 MENU UTILISATEUR

Ce menu vous permet d'accéder et de régler les paramètres suivants :

- **1:** CHOISIR LA TEMPÉRATURE DE CONFORT.
- **2:** CHOISIR LA TEMPÉRATURE ÉCONOMIE.
- **3:** CHOISIR LA TEMPÉRATURE ANTIGEL.
- **4:** CALIBRER LA TEMPÉRATURE AMBIANTE.
- **5:** FIXER LE JOUR DE LA SEMAINE (**Le radiateur doit être en mode AUTO**).
- **6:** RÉGLER LA MINUTERIE (**Le radiateur doit être en mode AUTO**).
- **7:** ÉTABLIR UN PROGRAMME QUOTIDIEN OU HEBDOMADAIRE.
- **8:** ACTIVER OU DÉSACTIVER LA FONCTION "FENÊTRES OUVERTES".
- **9:** ACTIVER OU DÉSACTIVER LA FONCTION INTELLIGENTE "ITCS".
- **10:** CONNAÎTRE LA CONSOMMATION D'ÉLECTRICITÉ QUOTIDIENNE, HEBDOMADAIRE OU MENSUELLE.

3.5.1 COMMENT ACCÉDER AU MENU UTILISATEUR ?

1 Appuyez et maintenez la touche .

2 Des bandes horizontales apparaîtront à l'écran. Puis le **paramètre 1**, "Sélection de la température de confort" s'affichera.



3 En appuyant sur la touche  ou  vous pourrez choisir, parmi les 10 paramètres disponibles, le paramètre à modifier.

**PARAMÈTRE 1
SÉLECTION DE LA
TEMPÉRATURE DE CONFORT**



Appuyez

**PARAMÈTRE 2
SÉLECTION DE LA
TEMPÉRATURE ECONOMIE**



Appuyez

**PARAMÈTRE 3
SÉLECTION DE LA
TEMPÉRATURE HORS-GEL**



Appuyez

**PARAMÈTRE 4
ETALONNAGE DE LA TEMPÉRATURE**



Appuyez

**PARAMÈTRE 5
RÉGLAGE DU JOUR DE LA SEMAINE
(AUTO seulement)**



Appuyez

**PARAMÈTRE 10
INDICATEUR DE
CONSOMMATION**



Appuyez

**PARAMÈTRE 9
SÉLECTION
FONCTION "ITCS"**



Appuyez

**PARAMÈTRE 8
SÉLECTION DES
FENÊTRES OUVERTES**



Appuyez

**PARAMÈTRE 7
PROGRAMMATION**



Appuyez

**PARAMÈTRE 6
RÉGLAGE DE
L'HEURE (AUTO seulement)**







1 PARAMÈTRE 1 : SÉLECTIONNER LA TEMPÉRATURE DE CONFORT

Le radiateur permet d'effectuer un **programme jour par jour, heure par heure**. Chaque jour de la semaine, vous pouvez choisir le mode confort, économie, hors-gel ou OFF.

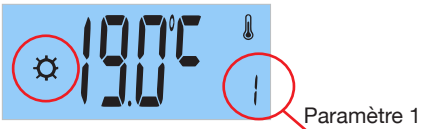
La température de confort est la température que vous souhaitez atteindre pendant les heures où la pièce est occupée.

Le paramètre 1 permet de régler la température de confort pré réglée :

<p>Étape 1: Accédez au menu utilisateur en appuyant sur de manière continue sur la touche . Le paramètre 1 s'affiche.</p>	
<p>Étape 2: Appuyez sur la touche  pour confirmer.</p>	
<p>Étape 3: Appuyez sur la touche  ou  pour choisir la température de confort souhaitée. Appuyez sur la touche  pour confirmer.</p>	



- Le réglage de la température de confort peut se faire entre 16 et 30 °C.
- Nous vous recommandons de choisir une température de confort entre 20 et 21 °C.



Lorsque vous sélectionnez la température souhaitée, un voyant situé au-dessus de l'écran changera de couleur en fonction de la température de consigne choisie.

- **Rouge** si la température choisie est égale ou supérieure à 24 °C.
- **Orange** si la température choisie est comprise entre 19,5 et 23,5 °C.
- **Vert** si elle est inférieure à 19,5°C.











Les températures de chaque mode de fonctionnement sont pré réglées en usine. Ce sont les températures conseillées pour votre confort, pour une consommation électrique raisonnable, il est déconseillé de dépasser ces températures.

2 PARAMÈTRE 2 : RÉGLAGE TEMPÉRATURE D'ÉCONOMIE

La température d'économie est la température souhaitée pendant la nuit ou pendant les courtes périodes d'absence. Cela évite que la température ambiante de la pièce ne descende trop bas.

Pour modifier la température d'économie pré-réglée :

<p>Étape 1: Accédez au menu utilisateur en appuyant sur . Le paramètre 1 s'affiche.</p>	 <p>Paramètre 1</p>
<p>Étape 2: Appuyez successivement sur la touche  ou  jusqu'à ce que le paramètre 2 soit sélectionné. Appuyez sur la touche  pour confirmer.</p>	 <p>Paramètre 2</p>
<p>Étape 3: Appuyez sur la touche  ou  pour sélectionner la température d'économie souhaitée. Appuyez sur la touche  pour confirmer.</p>	



- Le réglage de la température d'économie peut se faire entre 12 et 18,5 °C.
- Nous vous recommandons de choisir une température d'économie comprise entre 15 et 17 °C.









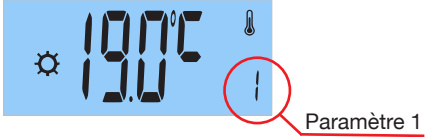

Lorsque vous sélectionnez la température d'économie, le voyant au-dessus de l'écran sera de couleur **Vert**.

3 PARAMÈTRE 3 : SÉLECTIONNER LA TEMPÉRATURE HORS-GEL

La température hors-gel est la température qui est utilisée pendant de longues périodes d'absence, pour empêcher les canalisations de votre maison de geler.

Pour modifier la température hors-gel pré réglée :

<p>Étape 1: Accédez au menu utilisateur en appuyant sur . La paramètre 1 s'affiche.</p>	
<p>Étape 2: Appuyez successivement sur la touche  ou  jusqu'à ce que le paramètre 2 soit sélectionné. Appuyez sur la touche  pour confirmer.</p>	
<p>Étape 3: Appuyez sur la touche  ou  pour choisir la température d'hors-gel souhaitée. Appuyez sur la touche  pour confirmer.</p>	



- La température hors-gel peut être réglée entre 5 et 10 °C.
- Nous vous recommandons de choisir une température hors-gel comprise entre 5 et 7 °C.











Lorsque vous définissez la température hors-gel, le voyant lumineux au-dessus de l'écran deviendra **Vert**.

4 PARAMÈTRE 4: ETALONNAGE DE LA TEMPÉRATURE

Le paramètre 4 permet de régler la température ambiante mesurée par le radiateur. Cet étalonnage compense une éventuelle différence entre la température atteinte dans la pièce et la température que vous avez programmée pour le radiateur.

L'étalonnage doit être effectué après 1 jour de fonctionnement et s'il y a une grande différence entre la température ambiante de la pièce et la température ambiante mesurée par le radiateur.

1. Placez un thermomètre de précision dans la pièce éloignée du radiateur.
2. Après une heure de chauffage, enregistrez la température mesurée sur le thermomètre de précision.

<p>Étape 1: Accédez au menu utilisateur en appuyant sur  de manière continue. Le paramètre 1 s'affiche.</p>	 <p>Paramètre 1</p>
<p>Étape 2: Appuyez successivement sur la touche  ou  jusqu'à ce que le paramètre 4 soit sélectionné. L'écran affiche alternativement la température ambiante de la pièce et la valeur de compensation.</p>	
<p>Étape 3: Appuyez sur la touche  pour confirmer.</p>	 <p>Température ambiante</p> <p>Paramètre 4</p>
<p>Étape 4: En appuyant sur la touche  ou  entrez la valeur de la température notée précédemment. Une fois la valeur de température saisie, appuyez sur la touche  pour confirmer. L'écran affiche alternativement la nouvelle température et la valeur de compensation qui en résulte (par ex. de 22 à 24 °C).</p>	
	



La plage de compensation est de + 5 °C / - 5 °C.

5 PARAMÈTRE 5 : RÉGLER LE JOUR DE LA SEMAINE



Le radiateur doit être en mode AUTO.

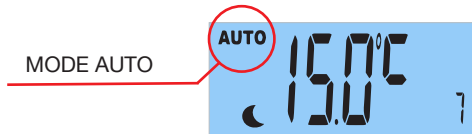

Le jour de la semaine se règle automatiquement lorsque vous configurez le jour, le mois et l'année en cours.

<p>Étape 1: Accédez au menu utilisateur en appuyant sur de manière continue. Le paramètre 1 s'affiche.</p>	
<p>Étape 2: Appuyez successivement sur la touche ou jusqu'à ce que vous sélectionniez le paramètre 5. L'écran affiche alternativement le jour, le mois et l'année. Appuyez sur la touche pour continuer.</p>	
<p>Étape 3: En appuyant sur la touche ou sélectionnez l'année en cours. Appuyez sur la touche pour confirmer.</p>	
<p>Étape 4: En appuyant sur la touche ou sélectionnez le mois en cours. Appuyez sur la touche pour confirmer.</p>	
<p>Étape 5: Sélectionnez le jour en cours en appuyant sur ou . Appuyez sur pour confirmer.</p>	
<p>Étape 6: Pour terminer, appuyez sur la touche .</p>	

6 PARAMÈTRE 6 : RÉGLAGE DE L'HEURE



Le radiateur doit être en mode AUTO.

MODE AUTO



Vous pouvez modifier l'heure et les minutes (format 24 heures).



<p>Étape 1: Accédez au menu utilisateur en appuyant sur de manière continue. Le paramètre 1 s'affiche.</p>	
<p>Étape 2: Appuyez successivement sur la touche ou jusqu'à ce que vous sélectionniez le paramètre 6. L'écran affiche alternativement l'heure et les minutes. Appuyez sur la touche pour continuer.</p>	
<p>Étape 3: En appuyant sur la touche ou sélectionnez l'heure. Appuyez sur la touche pour confirmer.</p>	
<p>Étape 4: Sélectionnez les minutes en appuyant ou . Appuyez sur la touche pour confirmer.</p>	
<p>Étape 5: Pour terminer, appuyez sur la touche .</p>	

7 PARAMÈTRE 7: PROGRAMMATION

Votre radiateur peut fonctionner manuellement ou automatiquement (avec programmation).

Parce qu'il tient compte de vos besoins, de votre confort, de votre orientation et durée de présence dans votre logement, le radiateur vous offre la possibilité de créer un programme personnalisé.

Vous avez 3 options pour programmer votre radiateur : "dAY" / "PArt" / "ALL".

OPTIONS	EXPLICATION DU PROGRAMME
<p>OPTION "DAY"</p> 	<p>Vous n'avez pas de routine quotidienne ? Chaque jour de la semaine est-il différent ? Choisissez l'option "DAY" pour configurer un programme différent pour chaque jour de la semaine. Si votre routine quotidienne est différente pour chaque jour de la semaine, nous vous recommandons cette option.</p>
<p>OPTION "PART"</p> 	<p>Votre routine quotidienne se répète du lundi au vendredi ? Votre routine est-elle la même le week-end ? Choisissez l'option "PART" si vous souhaitez un programme du lundi au vendredi et un autre pour le week-end.</p>
<p>OPTION "ALL"</p> 	<p>Choisissez l'option "ALL" si vous souhaitez le même programme pour tous les jours de la semaine. Cette option est idéale pour les utilisateurs qui ont la même routine quotidienne toute la semaine.</p>



Par défaut, le programme hebdomadaire défini en usine est :

- **De lundi au vendredi :**

Le radiateur fonctionne en mode confort de 6h à 9h, de 12h à 14h et de 18h à 23h. Le reste du temps, le radiateur sera en mode économie.

- **Du samedi au dimanche :**

Le radiateur fonctionne en mode confort de 8h à 23h. Le reste du temps, le radiateur sera en mode économie.

Étape 1: Accédez au menu utilisateur en

appuyant sur  de manière continue. Le paramètre 1 s'affiche.

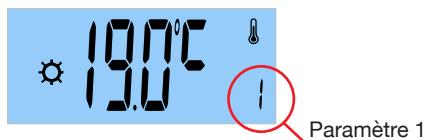



Étape 2: Appuyez successivement sur la

touche  ou  jusqu'à ce que vous sélectionniez le paramètre 7.

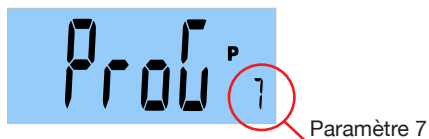
Sur l'écran s'affiche PROG. Appuyer sur  pour continuer.



Étape 3: En appuyant sur la touche 

ou  et en fonction du tableau ci-dessus, sélectionnez l'une des trois options pour programmer votre radiateur. Appuyez sur la touche  pour confirmer l'option souhaitée.







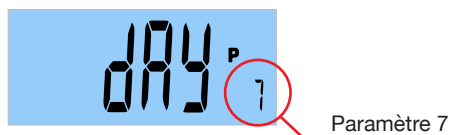

Étape 4:

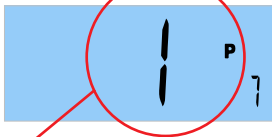
- Si vous avez choisi l'option "DAY", reportez-vous à la page 100.
- Si vous avez choisi l'option "PART", reportez-vous à la page 103.
- Si vous avez choisi l'option "ALL", reportez-vous à la page 106.

7.1 Si vous avez choisi l'option de programmation "dAY":



<p>Étape 5 : Appuyez sur la touche  pour commencer à configurer cette option. Le jour 1 apparaît (1 = Lundi). La programmation commence le premier jour de la semaine et à 00 h.</p>	 <p>LUNDI</p>
<p>Étape 6 : Pour passer d'un jour à l'autre appuyez sur la touche  ou  :</p> <p>1 = Lundi, 2 = Mardi, 3 = Mercredi, 4 = Jeudi, 5 = Vendredi, 6 = Samedi, 7 = Dimanche</p>	 <p>MARDI</p>
<p>Étape 7: Une fois que vous avez choisi le jour de la semaine, appuyez sur  pour confirmer.</p> <p>L'écran indique 00 h (minuit) du jour de la semaine choisi et le mode ÉCONOMIE.</p> <p>Sélectionnez ensuite un mode de fonctionnement heure par heure :</p>	 <p>ÉCONOMIE</p> <p>HEURE</p>

3. FONCTIONNEMENT

FR

Étape 8: Dans la première tranche horaire, 00h à 01h, appuyez successivement sur  pour sélectionner le mode de fonctionnement : confort, OFF, hors-gel ou économie. Quel mode de fonctionnement choisir ?



MODE CONFORT

Veillez sélectionner le mode **CONFORT** si pendant la tranche horaire la chambre est occupée.

Avec ce mode, le radiateur fonctionnera selon la température de confort choisie dans le **paramètre 1**.

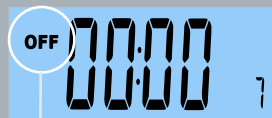

MODE ARRÊT

Veillez sélectionner le mode **OFF** si dans la la tranche horaire la pièce n'a pas besoin d'être chauffée.



MODE HORS-GEL

Le mode **HORS-GEL** est généralement utilisé pour de longues périodes d'absence pendant lesquelles vous voulez éviter les problèmes de gel des canalisations.

Dans ce mode, le radiateur fonctionnera selon la température hors-gel sélectionnée dans le **paramètre 3**.



MODE ÉCONOMIE

Le mode **ÉCONOMIE** est utilisé pendant la nuit ou lors de courtes périodes d'absence. Il permet d'éviter que la température de la pièce ne descende trop bas.



Dans ce mode, le radiateur fonctionnera selon la température de confort choisie dans le **paramètre 2**.

Étape 9: Une fois que vous avez choisi le mode de fonctionnement pour la tranche horaire de

00:00 à 01:00h, appuyez sur la touche  pour continuer à configurer la tranche horaire suivante. Répétez ce processus heure par heure.

FR



Appuyez sur  ou  pour faire défiler chaque tranche horaire.

Étape 10: Dans la dernière tranche horaire de la journée, **END** s'affiche à l'écran.

Étape 11: Pour confirmer la programmation, appuyez sur la touche .

Étape 12: Pour quitter le menu de programmation, appuyez sur la touche .

Une fois le programme horaire configuré, le radiateur répondra au programme réglé à condition que le **mode de fonctionnement sélectionné soit le mode AUTO**.











Appuyez deux fois sur la touche  pour quitter le menu de programmation, **SANS SAUVEGARDER LES DONNÉES.**

7.2 Si vous avez choisi l'option de programmation "PART":



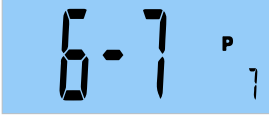











Vous pouvez configurer deux périodes : du lundi au vendredi et du samedi au dimanche.

La programmation du lundi se répétera jusqu'au vendredi et la programmation du samedi se répétera le dimanche.

<p>Étape 5: Appuyez sur  pour commencer à configurer cette option. Sur l'écran apparaîtra 1-5 (Lundi à Vendredi).</p>	
<p>Étape 6: Appuyez sur la touche  ou  pour choisir la période du lundi au vendredi (1-5) ou la période du samedi au dimanche (6-7).</p> <div style="display: flex; justify-content: space-around; align-items: center;">   </div>	
<p>Étape 7: Une fois que vous avez choisi le jour de la semaine, appuyez sur  pour confirmer. L'affichage indique 00 h (minuit) le premier jour de la période choisie, ainsi que le mode ÉCONOMIE.</p> <div style="display: flex; align-items: center; justify-content: center;"> <div style="margin-right: 20px;"> <p>ÉCONOMIE</p> <p>HEURE</p> </div>  </div>	
<p>Étape 8: Pour la première tranche horaire de 00h à 01h le lundi, appuyez successivement sur la touche  pour choisir le mode de fonctionnement souhaité : confort, OFF, hors-gel ou économie.</p>	
<p>Étape 9: Une fois que vous avez choisi le mode de fonctionnement pour la tranche horaire de 00 h à 01 h, appuyez sur la touche  pour passer à la tranche horaire suivante. Répétez ce processus pour chaque tranche horaire.</p>	

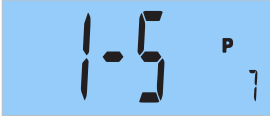

Appuyez sur  ou  pour faire défiler chaque tranche horaire.

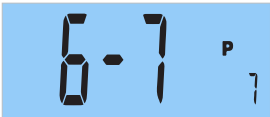
<p>Étape 10: Dans la dernière tranche horaire de la journée, END, s'affiche à l'écran.</p>	
<p>Étape 11: Appuyez sur la touche  . Le programme effectué le lundi se répétera jusqu'au vendredi.</p>	
<p>Étape 12: Pour lancer la programmation de la période du samedi au dimanche, appuyez sur la touche  .</p>	
<p>Étape 13: Appuyez sur la touche  ou  pour sélectionner à nouveau l'option PArt.</p>	
<p>Étape 14: Appuyez sur la touche  . 1 - 5 (du lundi au vendredi) s'affiche.</p>	
<p>Étape 15: Appuyez sur la touche  ou  pour sélectionner la période de samedi à dimanche (6-7).</p>	

Étape 16: Appuyez sur la touche  pour confirmer. L'affichage indique **00 h (minuit) le samedi ainsi que le mode ÉCONOMIE.**

ÉCONOMIE



HEURE

Étape 17: Pour la première tranche horaire de 00h à 01h le lundi, appuyez successivement sur la touche  pour choisir le mode de fonctionnement souhaité : confort, OFF, hors-gel ou économie.

Étape 18: Une fois que vous avez choisi le mode de fonctionnement pour la tranche horaire de 00 h à 01 h, appuyez sur la touche  pour passer à la tranche horaire suivante. Répétez ce processus pour chaque tranche horaire.

Étape 19: Dans la dernière tranche horaire de la journée, **END s'affiche à l'écran.**



Étape 20: Pour quitter le menu de programmation, appuyez sur la touche . Le programme réalisé le samedi se répétera également le dimanche.



Appuyez deux fois sur  pour quitter le menu de programmation, **SANS SAUVEGARDER** les données.

7.3 Si vous avez sélectionné l'option de programmation "ALL":



Vous pouvez configurer le même programme du lundi au dimanche. La programmation effectuée pour le lundi, se répétera jusqu'au dimanche.

Étape 16: Appuyez sur la touche  pour confirmer. L'affichage indique 00 h (minuit) le samedi ainsi que le mode ÉCONOMIE.

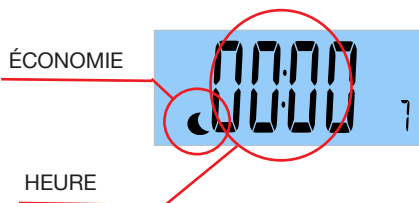

Étape 17: Pour la première tranche horaire de 00h à 01h le lundi, appuyez successivement sur la touche  pour choisir le mode de fonctionnement souhaité : confort, OFF, hors-gel ou économie.

Étape 18: Une fois que vous avez choisi le mode de fonctionnement pour la tranche horaire de 00 h à 01 h, appuyez sur la touche  pour passer à la tranche horaire suivante. Répétez ce processus pour chaque tranche horaire.

Étape 19: Dans la dernière tranche horaire de la journée, **END s'affiche à l'écran.**



Étape 20: Pour quitter le menu de programmation, appuyez sur la touche . Le programme effectué pour le lundi se répétera jusqu'au dimanche.

Une fois la programmation effectuée, le radiateur suivra ce programme **à condition que le mode de fonctionnement sélectionné soit le mode AUTO.**





Appuyez deux fois sur la touche  pour quitter le menu de programmation, **SANS SAUVEGARDER** les données.



IMPORTANT : Annulation temporaire d'un programme en cours:

Cette fonction permet de modifier temporairement la température de consigne jusqu'au prochain changement de température programmé ou lorsque plus de 2 heures se sont écoulées depuis la modification.

Étape 1: Lorsque le radiateur est en mode **Auto**, appuyez sur la touche  ou  pour modifier temporairement la température de consigne.

Étape 2: Appuyez sur  sur pour confirmer.

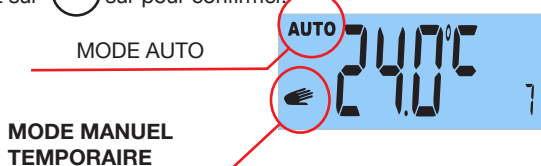

Ce changement sera automatiquement annulé lors du prochain changement de programme ou lorsque plus de 2 heures se seront écoulées depuis le changement.















IMPORTANT:

- Le radiateur obéira selon le mode de fonctionnement (confort / économie / antigel / OFF) qui s'affiche à l'écran.
- N'oubliez pas que le radiateur doit être en mode AUTO pour que la programmation configurée se réalise.
- Vous pouvez toujours modifier les températures attribuées au mode confort, économie ou antigel, en modifiant respectivement le paramètre 1, le paramètre 2 ou le paramètre 3.
- La température indiquée sur l'écran est la température réglée dans le mode de fonctionnement en cours.
- Le symbole  s'affiche lorsque la résistance de l'appareil est en marche.

8 PARAMÈTRE 8 : FONCTION D'ÉCONOMIE " FENÊTRES OUVERTES "

Avec cette fonction, lorsque le radiateur détecte une baisse soudaine de la température dans la pièce suite à l'ouverture d'une fenêtre, celui-ci s'arrête de fonctionner afin d'économiser de l'énergie.

Cette fonction intelligente est activée par défaut. Elle peut être désactivée si vous le souhaitez.

<p>Étape 1: Accédez au menu utilisateur en appuyant sur  de manière continue. Le paramètre 1 s'affiche.</p>	 <p>Paramètre 1</p>
<p>Étape 2: Appuyez successivement sur  ou  jusqu'à ce que le paramètre 8 soit sélectionné. Appuyez sur la touche  pour confirmer.</p>	 <p>Paramètre 8</p>
<p>Étape 3: Appuyez sur la touche  ou  pour activer ou désactiver la fonction. Appuyez sur la touche  pour confirmer.</p> <div style="display: flex; justify-content: space-around; align-items: center;"> <div data-bbox="241 963 510 1082">  <p>Fonction Activée</p> </div> <div data-bbox="605 963 874 1082">  <p>Fonction Désactivée</p> </div> </div>	
<p>Étape 4: Pour quitter le menu de programmation, appuyez sur la touche .</p>	













Appuyez deux fois sur la touche  pour quitter le menu de programmation, **SANS SAUVEGARDER** les données.

9 PARAMÈTRE 9 : FONCTION INTELLIGENTE “ ITCS ”

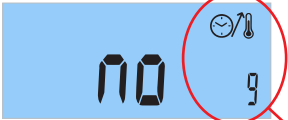
Le radiateur intègre un **système innovant de contrôle intelligent de la température ITCS**.

Ce système active la mise en marche de l'appareil **avant l'heure programmée** (2 heures maximum), afin de garantir l'obtention de la température souhaitée à l'heure indiquée et selon le programme hebdomadaire établi.

Cette fonction intelligente est activée par défaut. Elle peut être désactivée si vous le souhaitez.

<p>Étape 1: Accédez au menu utilisateur en appuyant sur de manière continue sur la touche  . Le paramètre 1 s'affiche.</p>	 <p>Paramètre 1</p>
<p>Étape 2: Appuyez successivement sur la touche  ou  jusqu'à ce que le paramètre 9 soit sélectionné. Appuyez sur la touche  pour confirmer.</p>	 <p>Paramètre 9</p>
<p>Étape 3: Pour activer ou désactiver la fonction, appuyez sur la touche  ou  . Appuyez sur la touche  pour confirmer.</p> <div style="display: flex; justify-content: space-around; align-items: center;"> <div data-bbox="225 967 493 1082">  <p>Fonction Désactivée</p> </div> <div data-bbox="589 967 857 1082">  <p>Fonction Activée</p> </div> </div>	
<p>Étape 4: Pour quitter le menu de programmation, appuyez sur la touche  .</p>	



Appuyez deux fois sur la touche  pour quitter le menu de programmation, **SANS SAUVEGARDER** les données.

10 PARAMÈTRE 10 : FONCTION “ INDICATEUR DE CONSOMMATION ”

Le radiateur intègre une fonction unique sur le marché qui vous permet de connaître votre consommation électrique pendant les dernières 24 heures, les 7 derniers jours et les 30 derniers jours.



- **Important : Afin de connaître la consommation électrique, vous devez d’abord saisir la valeur de puissance de votre radiateur (voir page 115).**
- **Le radiateur mémorise les données de consommation toutes les 4 heures.**

<p>Étape 1: Accédez au menu utilisateur en appuyant sur de manière continue. Le paramètre 1 s’affiche.</p>	
<p>Étape 2: Appuyez successivement sur la touche ou jusqu’à ce que le paramètre 10 soit sélectionné. Appuyez sur la touche pour confirmer.</p>	
<p>L’écran affiche alternativement la consommation (en kWh) des dernières 24 heures :</p> <div style="display: flex; justify-content: space-around;"> <div data-bbox="68 842 313 986"> <p>Consommation en kWh</p> </div> <div data-bbox="313 842 591 986"> </div> </div>	
<p>Étape 3: Appuyez successivement sur la touche ou pour connaître la consommation d’électricité au cours des 7 derniers jours et des 30 derniers jours.</p> <div style="display: flex; justify-content: space-around;"> <div data-bbox="252 1093 520 1212"> </div> <div data-bbox="599 1093 868 1212"> </div> </div>	
<p>Étape 4: Pour quitter le menu, appuyez deux fois sur la touche .</p>	



Dans l’option “consommation dernières 24heures” vous pouvez connaître la consommation totale du radiateur à partir du premier jour de fonctionnement en appuyant en continu sur la touche .



11 PARAMÈTRE 11 : END

Étape 1: Vous avez atteint la fin du menu utilisateur.



Étape 2: Appuyez sur la touche  pour quitter le menu utilisateur.

3.6 MENU AVANCÉ

Ce menu vous permet d'accéder et de régler les paramètres suivants :

- **1:** SÉLECTION DES DEGRÉS CELSIUS °C ou FARENHEIT °F.
- **2:** ACTIVER ou DESACTIVER LA FONCTION "FIL PILOTE"(pour la France). Une centrale de commande (non incluse) est requise.
- **3:** INDICATION DE LA VERSION DU LOGICIEL.
- **4:** RÉGLAGE DE LA VALEUR DE PUISSANCE DU RADIATEUR.
- **5:** FONCTION DE RÉINITIALISATION.
- **6:** FIN DU MENU AVANCÉ.

3.6.1 COMMENT ACCÉDER AU MENU AVANCÉ ?

Étape 1: Appuyez et maintenez la touche . Des bandes horizontales apparaîtront à l'écran, puis le paramètre 1, "Sélection de la température de confort" s'affichera.

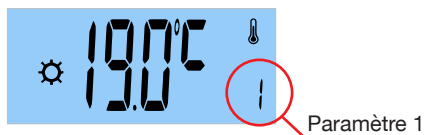

Étape 2: Appuyez successivement sur la touche  ou  jusqu'à la sélection du paramètre 11 "END".







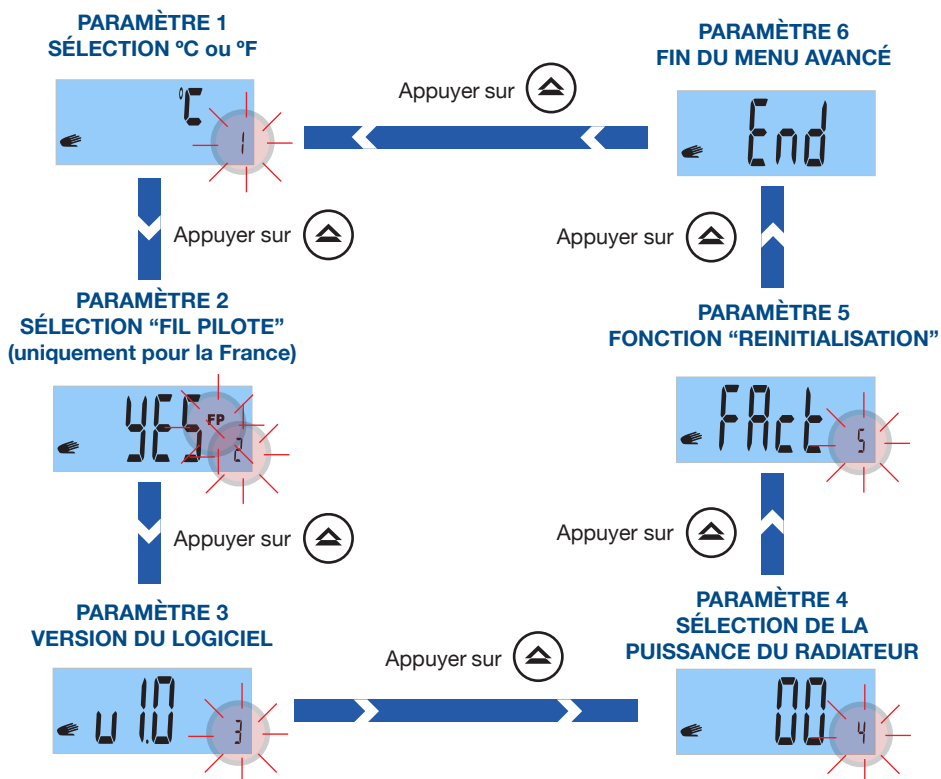



Étape 3: Appuyez et maintenez la touche . Des bandes horizontales s'afficheront à l'écran. Puis le paramètre 1, "CHOIX DES DEGRÉS CELSIUS °C / FARENHEIT °F". s'affichera.

Étape 4: Appuyez sur la touche  ou  pour sélectionner le paramètre avancé que vous souhaitez modifier.



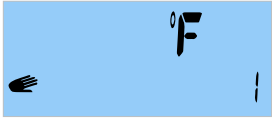







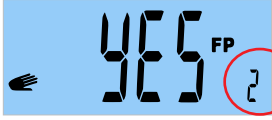

1 PARAMÈTRE 1 : SÉLECTIONNER DEGRÉS CELSIUS / FARENHEIT

Sélectionnez degrés Celsius (°C) ou degrés Fahrenheit (°F).

<p>Étape 1: Accédez au menu avancé.</p>	
<p>Étape 2: Appuyez sur la touche  pour confirmer.</p>	
<p>Étape 3: Appuyez sur la touche  ou  pour choisir °C ou °F. Appuyez sur  pour confirmer.</p>	
<p>Étape 4: Appuyez sur la touche  ou  pour sélectionner un autre paramètre avancé ou appuyez sur la touche  pour quitter le menu avancé.</p>	





2 PARAMÈTRE 2 : SÉLECTION DE LA FONCTION “FIL PILOTE” (uniquement pour la France et nécessite une centrale de commande non incluse)

Cette fonction n'est opérationnelle qu'en France. Pour activer ou désactiver cette fonctionnalité, procédez comme suit :

<p>Étape 1: Accédez au menu avancé. Avec la touche  ou  sélectionnez 2.</p>	
<p>Étape 2: Appuyez sur la touche  pour confirmer.</p>	
<p>Étape 3: Appuyez sur la touche  ou  pour choisir Yes (Oui) ou No (Non). Appuyez sur la touche  pour confirmer.</p>	
<p>Étape 4: Appuyez sur la touche  ou  pour sélectionner un autre paramètre avancé ou appuyez sur la touche  pour quitter le menu avancé.</p>	

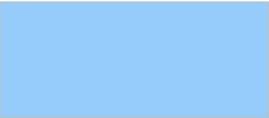

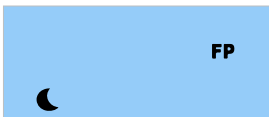

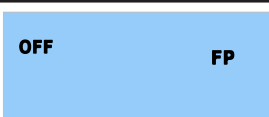

La fonction “Fil Pilote” ne fonctionne qu’en mode MANUEL.

Une fois la température sélectionnée en mode manuel, les différentes commandes “Fil Pilote” apparaissent comme suit :

COMMANDE “ FIL PILOTE “	ÉCRAN
Confort (Aucun ordre)	
Confort - 1°	
Confort - 2°	
Économie	
Hors-gel	
Arrêt	











3 PARAMÈTRE 3: VERSION DU LOGICIEL

Il indique la version actuelle du logiciel de votre radiateur.

<p>Étape 1: Accédez au menu avancé. Avec la touche  ou  sélectionnez 3.</p>	
<p>Étape 2: La version du logiciel de votre radiateur s'affiche.</p>	
<p>Étape 3: Appuyez sur la touche  ou  pour sélectionner un autre paramètre avancé ou appuyez sur la touche  pour quitter le menu avancé.</p>	

4 PARAMÈTRE 4 : SÉLECTIONNER LA PUISSANCE DU RADIATEUR





Pour que le paramètre 10 “indicateur de consommation” fonctionne correctement vous devez saisir la valeur de la puissance de votre radiateur. **La puissance (watts) est indiquée sur l'étiquette grise située sur le côté droit du radiateur à côté du câble d'alimentation.**

<p>Étape 1: Accédez au menu avancé. Avec la touche  ou  sélectionnez 4.</p>	
<p>Étape 2: Appuyez sur la touche  pour confirmer.</p>	
<p>Étape 3: Appuyez sur la touche  ou  pour sélectionner la puissance de votre radiateur (par exemple 1000W). Appuyez sur la touche  pour confirmer.</p>	
<p>Étape 4: Appuyez sur la touche  ou  pour sélectionner un autre paramètre avancé ou appuyez sur la touche  pour quitter le menu avancé.</p>	

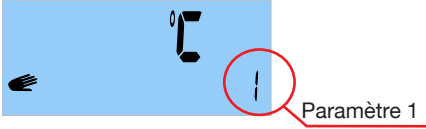

5 PARAMÈTRE 5 : “ RÉINITIALISATION ”

Ce paramètre nous permet de :

- **Effacer la programmation du radiateur.**
- **Effacer tous les paramètres sauf la puissance de votre radiateur (Paramètre avancé 4, page 115).**

<p>Étape 1: Accédez au menu avancé. En appuyant sur la touche  ou  sélectionnez 5.</p>	
<p>Étape 2: Pour réinitialiser le radiateur aux réglages d'usine initiaux, appuyez et maintenez la touche .</p>	
<p>Étape 3: Le processus de “réinitialisation” de votre radiateur commencera.</p> <p>Une fois le processus de “réinitialisation” terminé, le radiateur revient en mode manuel avec la température pré-réglée en usine (20 °C).</p> <p>Sélectionnez ensuite le mode de fonctionnement souhaité. Si vous sélectionnez le mode AUTO, vous devrez régler l'heure et le jour en cours. Reprogrammez votre radiateur et réglez les paramètres que vous souhaitez.</p>	

6 PARAMÈTRE 6 : END

<p>Étape 1: Vous avez atteint la fin du menu avancé</p>	
<p>Étape 2: Appuyez sur la touche  ou alors  pour quitter le menu avancé.</p>	

3. FONCTIONNEMENT

FR

3.7 FONCTION “ VERROUILLAGE CLAVIER ”

Appuyez simultanément sur les touches  et  jusqu'à ce que l'écran affiche **le symbole d'une clé**.



Répétez la même opération pour déverrouiller le clavier jusqu'à ce que le symbole de la clé disparaisse.



S'il y a une panne de courant alors que la fonction “ verrouillage du clavier ” est activée, le radiateur maintiendra le “ verrouillage du clavier ” activé.

3.8 MESSAGE D'ERREUR “ ERR ”

Si le message d'erreur “Err” s'affiche à l'écran en clignotant, cela signifie que le thermostat s'est déconnecté ou est en panne. Dans ce cas, veuillez contacter le service après vente.



4. ENTRETIEN

Votre appareil ne nécessite aucun entretien particulier.

Nettoyez uniquement la poussière qui peut s'accumuler avec un chiffon sec et doux.

Avant la remise en marche pour la saison hivernale, il est recommandé de nettoyer la poussière accumulée sur la surface du radiateur.



NE JAMAIS UTILISER DE SOLVANTS OU DE PRODUITS ABRASIFS.

FR

- **Leia as instruções de montagem.**
- Para desligar o emissor térmico da rede elétrica, retire a ficha de alimentação da tomada. **Nunca puxe o cabo.**
- Não deixe o cabo de ligação em contacto com o aparelho enquanto este estiver aceso.
- **A garantia do aparelho não cobre o não cumprimento das instruções.**



PERIGO: Não tape o aparelho. Não o use para secar roupa. Se o cobrir, corre o risco de um sobreaquecimento.



• **PERIGO: Se o cabo de alimentação estiver danificado, deve ser substituído pelo fabricante ou pelo serviço pós-venda.**



• **PERIGO: Num quarto de banho, o aparelho deve ser instalado de forma a não poder tocado por qualquer pessoa que se encontre na banheira ou duche.**



• **A instalação deve ser realizada levando em consideração estas instruções e de acordo com a legislação elétrica vigente.**

• Durante o funcionamento deve ter-se em atenção manter o aparelho afastado das matérias inflamáveis, tais como, cortinas, tapetes, móveis, etc.

• Verifique se o emissor está desligado antes de realizar qualquer operação no seu interior.

• Este aparelho deve ser ligado á terra.

• **O emissor deve ser instalado de tal maneira que a ficha de ligação esteja sempre acessível. Este emissor não se deve encastrar. Deve-se respeitar sempre as distâncias de segurança.**

• **O emissor dispõe de um bloqueio para evitar que as crianças alterem a programação.**

• Este aparelho não foi concebido para utilização por pessoas (incluindo crianças) com capacidades físicas, sensoriais ou mentais diminuídas nem com experiência ou conhecimento reduzido, exceto

sob supervisão de um responsável pela sua segurança com as instruções de utilização do aparelho. As crianças devem ser vigiadas para garantir que não brincam com o aparelho.

- As crianças com menos de 3 anos devem ser mantidas fora do alcance do aparelho, caso contrario devem estar supervisionadas permanente.

- As crianças com mais de 3 e menos de 8 anos devem só podem ligar/desligar o aparelho (on/off), se este estiver colocado ou instalado na posição de funcionamento defenitiva, se estiverem supervisionadas ou tenham recebido instruções de como usar o aparelho de forma segura e entenderam os riscos que o aparelho envolve.

- As crianças com mais de 3 anos e menos de 8 anos não devem ligar o aparelho na tomada de rede electrica, regular, limpar o aparelho ou realizar operações de manutenção.

- Este aparelho pode ser utilizado por crianças maiores de 8 anos e por pessoas com capacidades físicas, sensoriais ou mentais reduzidas, com pouca experiência ou conhecimento, desde que tenham sido devidamente treinados e são supervisionados por um adulto que conheça os riscos envolvidos.

- A limpeza e a manutenção deve efectuada por pessoas adultas não por crianças. As crianças não devem brincar com o aparelho.

- Deve ter-se um especial cuidado quando estão presentes crianças e pessoas com algum tipo de vulnerabilidade ou deficiência.



- **PERIGO: Algumas peças deste produto podem ficar muito quentes e causar queimaduras.** Deve prestar especial atenção na presença de crianças e de pessoas vulneráveis.



- **PERIGO:** Mantenha os sacos e os restantes acessórios incluídos fora do alcance das crianças.

- Evite tocar nas partes exteriores do emissor durante o funcionamento.

- É normal que na primeira colocação em funcionamento o aparelho liberte um cheiro “a novo”. Deixe o emissor funcionar num local ventilado durante duas ou três horas.

- O emissor **NÃO pode funcionar** com centrais externas de control.

- Antes de cada inverno ou depois de vários dias de inatividade, limpe

o aparelho antes de o ligar (siga os passos da secção 4 - Manutenção). Com esta limpeza evitará queimar o pó acumulado e outros resíduos.

- Durante o funcionamento do emissor a convecção emitida junto com outros fatores ambientais podem descolorar as superfícies metálicas.
- Mudanças bruscas de temperatura ambiente podem provocar “estalidos” e/ou ruidos no emisor. Isto não é indicativo de avaria no emisor.
- Deve ter em conta os requisitos estabelecidos pela legislação para o tratamento e reciclagem de resíduos quando deite o aparelho fora.



IMPORTANTE

• É indispensável que o emissor **SEJA FIXADO FIRMEMENTE A UMA PAREDE FIXA E NIVELADA.**

- Verifique se há alguma tomada perto de onde o vai colocar.
- Tire de dentro de caixa o escantilhão onde se indica a posição exacta dos furos.
- Para evitar problemas é necessária uma distância mínima de 15 cm entre o emissor e qualquer.

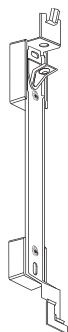
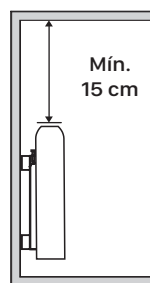
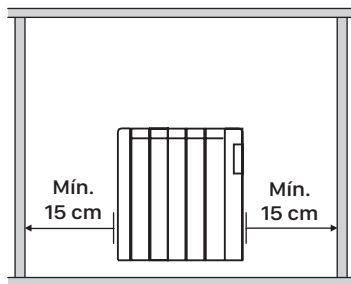

A

VERSÃO

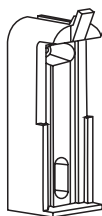

B

VERSÃO

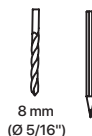

* Não incluído

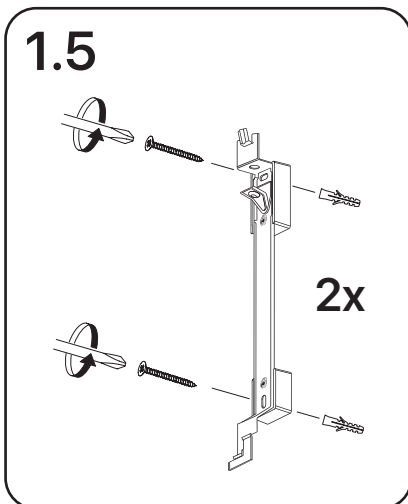
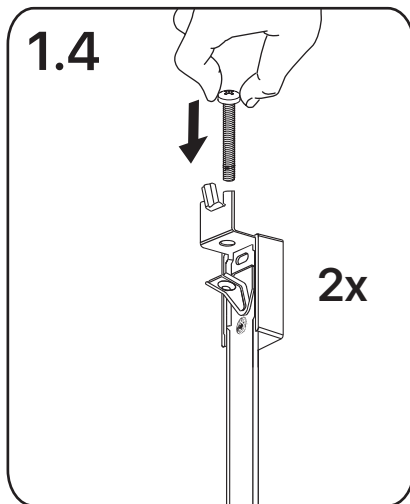
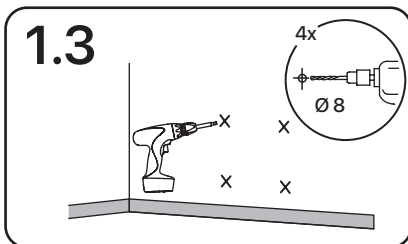
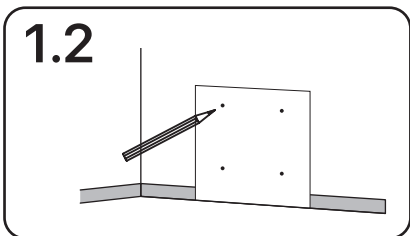
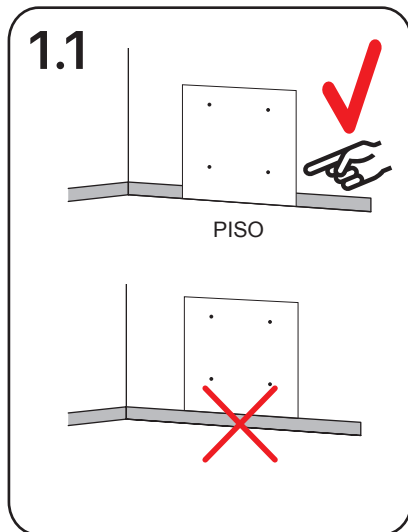
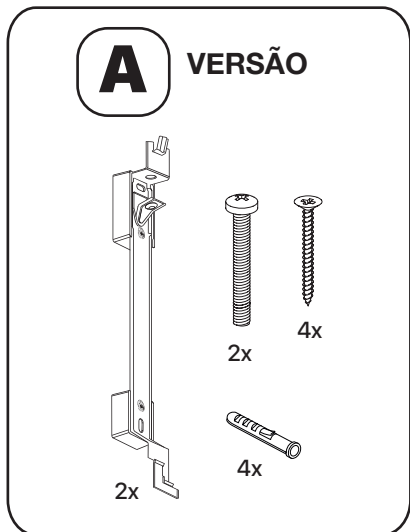

1.6

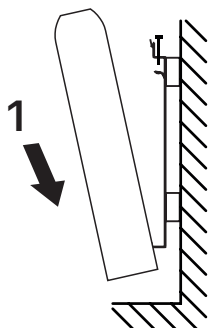

1.7

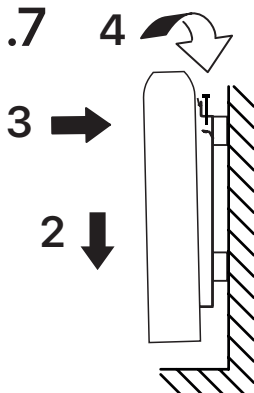

1.8

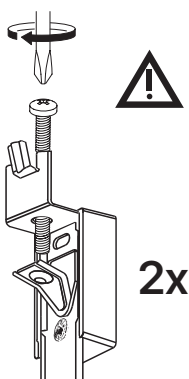

1.9

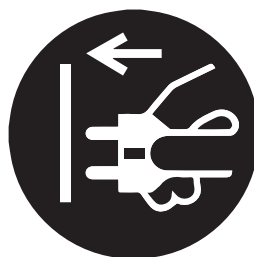

1.10

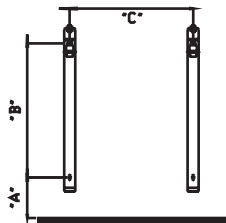
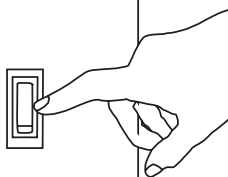

(W)	"A" (mm)	"B" (mm)	"C" (mm)
600	420	246	159
900	420	246	319
1200	420	246	478
1500	420	246	638
1800	420	246	638

2. INSTRUÇÕES DE INSTALAÇÃO

P

B VERSÃO

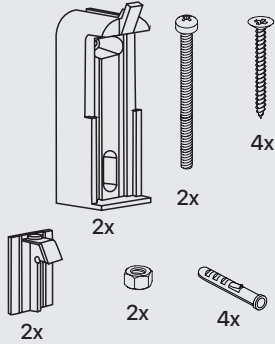

2.1

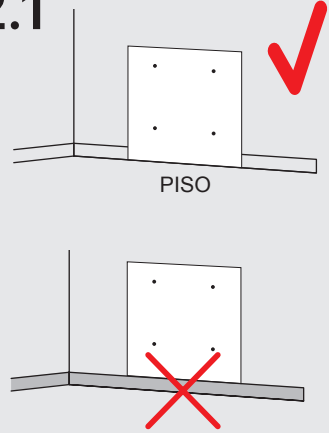

2.2

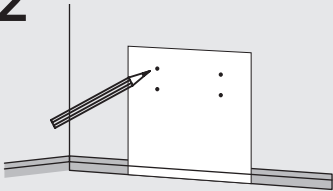

2.3

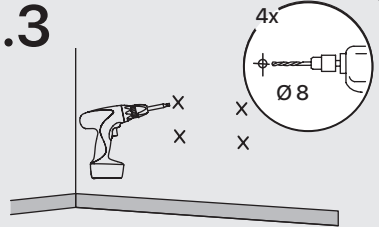

2.4

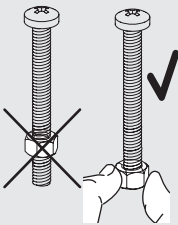

2.5

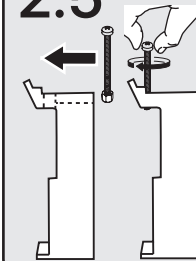

2.6

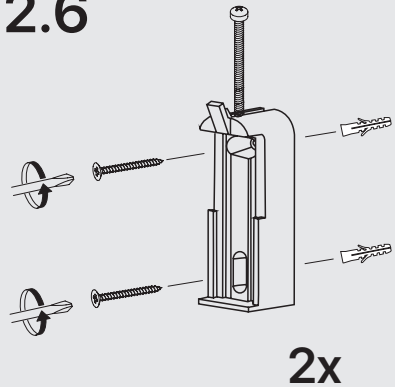

P

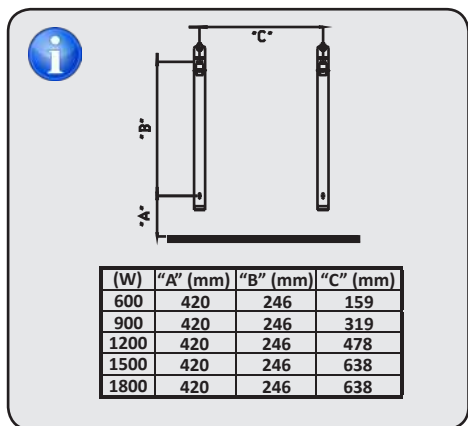
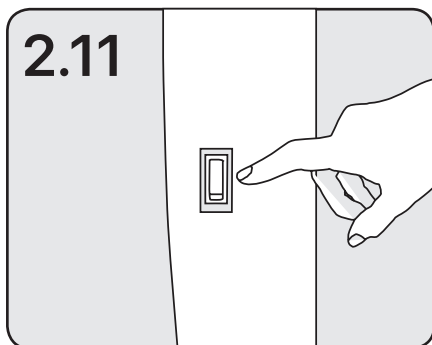
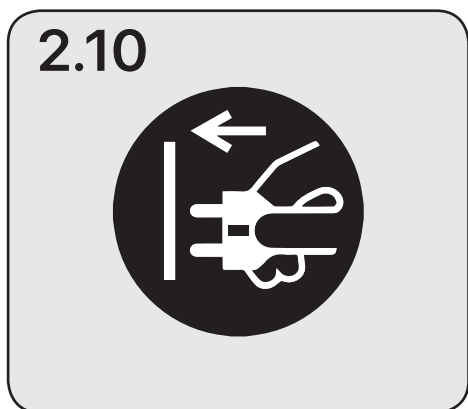
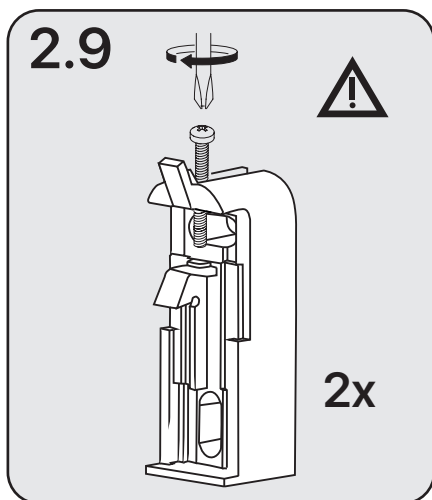
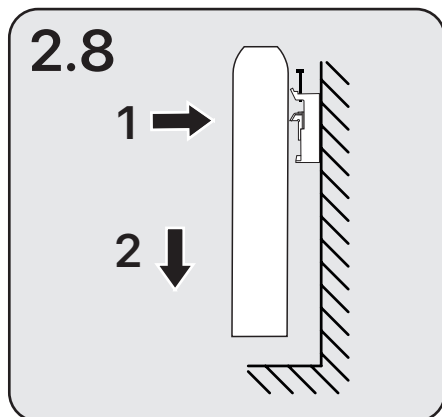
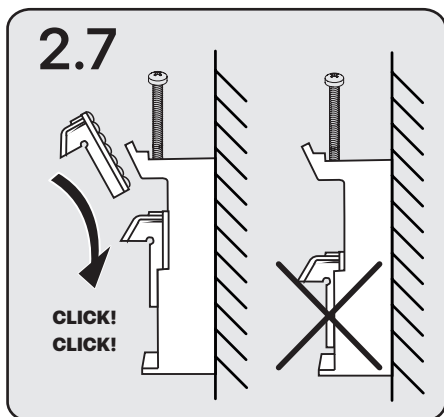

3. FUNCIONAMENTO

P

3.1 PAINEL DE CONTROLO

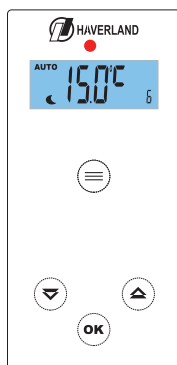

Tecla	Descrição
	Modos AUTO / DESLIGADO / ANTI-GELO / MANUAL
	Diminuir
	Aumentar
	Aceitar
	Indicador de cor da temperatura selecionada

3.2 ECRÃ

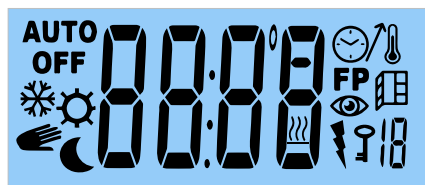

AUTO	Indicador do modo AUTOMÁTICO
	Indicador do modo ANTI-GELO / CONFORTO / MANUAL / ECONOMIA
OFF	Desligar
	Temperatura / Temporizador
	Indicador de resistência conectada
	Funções avançadas

P

3.3 INÍCIO - PRIMEIRA CONEXÃO

Assim que o radiador é ligado à rede e o interruptor, localizado no lado direito, é premido:

- 1 Todos os ícones são mostrados no ecrã:



- 2 Em seguida, um segundo ecrã aparece com a versão do software:



- 3 No terceiro ecrã:

- **Se o radiador estava no modo MANUAL / ANTI-GELO / DESLIGADO:**
 - O ecrã principal é exibido no modo MANUAL / ANTI-GELO / DESLIGADO. **Se usa o radiador no modo manual ou no modo Anti-gelo, não será necessário definir a hora e o dia atuais.**
- **Se antes da desconexão estava no modo AUTO:**
 - Se for a primeira vez ou **o radiador foi desconectado da corrente elétrica por mais de 6 horas, o radiador irá pedir definir a hora e o dia atuais.**
 - Se não for a primeira vez ou se o radiador não for desconectado por mais de 6 horas, o ecrã principal será exibido.



Se o tempo de desconexão elétrica for inferior a 6 horas, a hora atual e o dia da semana são mantidos na memória; mesmo irá lembrar o último modo de operação.





A programação e as temperaturas selecionadas são sempre mantidas na memória.

3.4 MODOS DE OPERAÇÃO

O radiador possui 4 modos de operação: **AUTO** / **OFF** / **ANTI-GELO** / **MANUAL**.

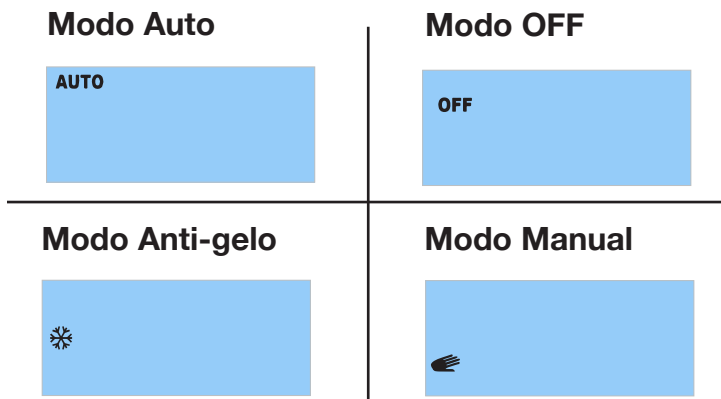
Para seleccionar o modo de operação, pressione sucessivamente a tecla .



Após seleccionar o modo de operação, pressione a tecla  para confirmar.

3.4.1 MODO AUTOMÁTICO (PROGRAMAÇÃO)

O radiador segue a programação realizada de acordo com as suas necessidades e de acordo com as temperaturas seleccionadas em qualquer modo de operação.

Passo 1: Para seleccionar o modo AUTO, pressione sucessivamente a tecla  até **AUTO** aparecer no ecrã.



IMPORTANTE: Se ao escolher o modo AUTO, a hora e o dia atuais não são configurados corretamente, o radiador irá perguntar a hora e o dia atuais (ver página 144, passo 3).

Passo 2: Pressione a tecla  para confirmar.



O símbolo de “chama” indica que o radiador está a aquecer; a temperatura ambiente é inferior à temperatura seleccionada. Assim que a temperatura seleccionada for atingida, o símbolo irá desaparecer do ecrã.



Pressione a  se quiser saber a temperatura.

3.4.2 MODO DESLIGADO

Passo 1:

Pressione a tecla  sucessivamente até que **OFF** apareça no ecrã.



Passo 2:

Pressione a tecla  para confirmar. O radiador permanece desligado.

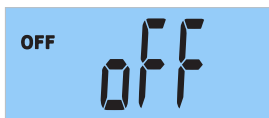

Para ligar o radiador, pressione a tecla  sucessivamente e seleccione o modo de operação pretendido, AUTO, ANTI-GELO ou MANUAL.

Pressione a tecla  para confirmar.

3.4.3 MODO ANTI-GELO

A temperatura padrão definida é 7°C. Este modo é utilizado para longos períodos de ausência quando se pretende evitar o congelamento das tubagens.

Passo 1:

Pressione a tecla  sucessivamente até que apareça  no ecrã.



Passo 2:

Pressione a tecla  para confirmar.



Pressione a tecla  se quiser saber a temperatura ambiente.

3.4.4 MODO MANUAL

Se não desejar programar o seu radiador, recomendamos-lhe que escolha o modo MANUAL, no qual pode selecionar a temperatura pretendida entre 12 e 30 °C.

Recomendamos escolher uma temperatura entre 20 - 21 °C.

Passo 1: Pressione a tecla  sucessivamente até que apareça  no ecrã.

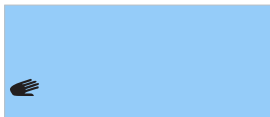

Passo 2: Pressione a tecla  para confirmar. A temperatura predefinida é mostrada no modo manual.



Passo 3: Pressione a tecla  ou  para definir a temperatura pretendida. Pressione a tecla  para confirmar.



O ajuste pode ser feito entre um mínimo de 12 °C e um máximo de 30 °C.



Durante a seleção da temperatura pretendida, uma luz piloto acima do ecrã irá mudar de cor de acordo com a temperatura de set-point selecionada.

- **Vermelho** se a temperatura escolhida for igual ou superior a 24 °C.
- **Laranja** se a temperatura escolhida estiver entre 19,5 e 23,5 °C.
- **Verde** se for inferior a 19,5°C.



Este símbolo indica que o radiador está a aquecer; a temperatura ambiente é mais baixa do que a temperatura selecionada. Assim que a temperatura selecionada for atingida, o símbolo irá desaparecer do ecrã.



- Recomendamos selecionar uma temperatura entre 20 e 21 °C.
- Pressione a tecla  se quiser saber a temperatura.

3.5 MENU DO USUÁRIO

Com este menu pode aceder e ajustar os seguintes parâmetros:



- **1:** ESCOLHER A TEMPERATURA DE CONFORTO.
- **2:** ESCOLHER A TEMPERATURA DE ECONOMIA.
- **3:** ESCOLHER A TEMPERATURA ANTI-GELO.
- **4:** CALIBRAR A TEMPERATURA AMBIENTE.
- **5:** AJUSTAR O DIA DA SEMANA (**O radiador deve estar no modo AUTO**).
- **6:** AJUSTAR TEMPORIZADOR (**O radiador deve estar no modo AUTO**).
- **7:** CONFIGURAR UM PROGRAMA DIÁRIO OU SEMANAL.
- **8:** ATIVAR OU DESATIVAR A FUNÇÃO “JANELAS ABERTAS”.
- **9:** ATIVAR OU DESATIVAR A FUNÇÃO INTELIGENTE “ITCS”.
- **10:** CONHECER O SEU CONSUMO DE ENERGIA DIÁRIO, SEMANAL OU MENSAL.

3.5.1 COMO ACEDER AO MENU DO UTILIZADOR?

1 Pressione e segure a tecla .

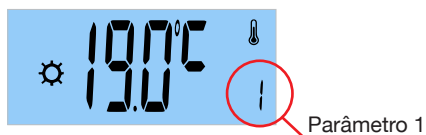
2 Irão aparecer no ecrã faixas horizontais. Então o **parâmetro 1**, “**Seleção de temperatura de conforto**” será mostrado.



3 Pressione a tecla  ou  para selecionar o parâmetro a ser modificado entre os 10 parâmetros disponíveis.

PARÂMETRO 1 SELEÇÃO DE TEMPERATURA CONFORTO

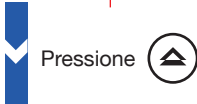

PARÂMETRO 2 SELEÇÃO TEMPERATURA ECONOMIA



PARÂMETRO 3 SELEÇÃO TEMPERATURA ANTI-GELO



PARÂMETRO 4 AJUSTE DE TEMPERATURA



PARÂMETRO 5 AJUSTE DIA SEMANA (apenas AUTO)



PARÂMETRO 10 INDICADOR DE CONSUMO



PARÂMETRO 9 SELEÇÃO DE FUNÇÃO "ITCS"

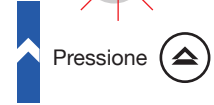

PARÂMETRO 8 SELEÇÃO DE JANELAS ABERTAS



PARÂMETRO 7 PROGRAMAÇÃO



PARÂMETRO 6 AJUSTE HORA (apenas em AUTO)









1 PARÂMETRO 1: SELECIONAR A TEMPERATURA DE CONFORTO

O radiador permite **realizar uma programação dia a dia, hora a hora. Cada dia da semana pode escolher Conforto, Economia, Anti-gelo ou Desligado.**

A temperatura de conforto é a temperatura que pretende ter durante as horas de ocupação da divisão.

O **parâmetro 1** permite ajustar a temperatura de conforto pré-definida:

<p>Passo 1: Aceda ao menu do utilizador premindo continuamente a tecla . O parâmetro 1 é mostrado.</p>	
<p>Passo 2: Pressione a tecla  para confirmar.</p>	
<p>Passo 3: Pressione a tecla  ou  ou para escolher a temperatura de conforto pretendida. Pressione a tecla  para confirmar.</p>	



- O ajuste da temperatura de conforto pode ser feito entre 16 e 30 °C.
- Recomendamos escolher uma temperatura de conforto entre 20 e 21 °C.



Durante a seleção da temperatura pretendida, uma luz piloto acima do ecrã irá mudar de cor de acordo com a temperatura de set-point selecionada.

- **Vermelho** se a temperatura escolhida for igual ou superior a 24 °C.
- **Laranja** se a temperatura escolhida estiver entre 19,5 e 23,5 °C.
- **Verde** se for inferior a 19,5°C.











As temperaturas em cada modo de funcionamento são **pré-definidas em fábrica**. Estas são as temperaturas recomendadas para o seu conforto, para um consumo elétrico razoável, não é aconselhável exceder estas temperaturas.

2 PARÂMETRO 2: SELECIONE A TEMPERATURA DE ECONOMIA

A temperatura de economia é aquela pretendida durante a noite ou nos períodos curtos de ausência. Evita que a temperatura ambiente da divisão caia demasiado baixo.

Para modificar a temperatura de economia predefinida:

<p>Passo 1: Aceda ao menu do utilizador premindo continuamente a tecla . O parâmetro 1 é mostrado.</p>	 <p>Parâmetro 1</p>
<p>Passo 2: Pressione a tecla  ou  até que o parâmetro 2 seja selecionado. Pressione a tecla  para confirmar.</p>	 <p>Parâmetro 2</p>
<p>Passo 3: Pressione a tecla  ou  para selecionar a temperatura de economia desejada. Pressione a tecla  para confirmar.</p>	



- O ajuste da temperatura de economia pode ser feito entre 12 e 18,5 °C.
- Recomendamos escolher uma temperatura de economia entre 15 e 17 °C.











Durante a seleção da temperatura de economia, a luz indicadora acima do ecrã é Verde.

3 PARÂMETRO 3: SELECIONAR TEMPERATURA ANTI-GELO

A temperatura Anti-gelo é a temperatura que é usada para longos períodos de ausência, evitando o congelamento de tubagens na sua casa.

Para modificar a temperatura anti-gelo predefinida:

<p>Passo 1: Acesse ao menu do utilizador premindo continuamente a tecla . O parâmetro 1 é mostrado.</p>	
<p>Passo 2: Pressione a tecla  ou  até que o parâmetro 3 seja selecionado.</p> <p>Pressione a tecla  para confirmar.</p>	
<p>Passo 3: Pressione a tecla  ou  para escolher a temperatura Anti-gelo pretendida.</p> <p>Pressione a tecla  para confirmar.</p>	



- O ajuste da temperatura de Anti-gelo pode ser feito entre 5 e 10 °C.
- Recomendamos a escolha de uma temperatura Anti-gelo entre 5 e 7 °C.



Durante a configuração da temperatura Anti-gelo, a luz indicadora acima do ecrã é Verde.

4 PARÂMETRO 4: CALIBRAÇÃO DA TEMPERATURA

O parâmetro 4 permite ajustar a temperatura ambiente medida pelo radiador. Esta calibração compensa uma possível diferença entre a temperatura obtida na divisão e a temperatura que programou no radiador.

A calibração deve ser feita após 1 dia de operação e se houver uma grande diferença entre a temperatura da divisão e a temperatura ambiente medida pelo radiador.

1. Coloque um termómetro de precisão na divisão, longe do radiador.
2. Após uma hora de aquecimento, registre a temperatura medida no termómetro de precisão.

<p>Passo 1: Aceda ao menumenu do utilizador premindo continuamente a tecla . O parâmetro 1 é mostrado.</p>	 <p>Parâmetro 1</p>
<p>Passo 2: Pressione sucessivamente as teclas  ou  até que o parâmetro 4 é selecionado. O ecrã mostra alternadamente a temperatura da divisão e o valor de compensação.</p>	
<p>Passo 3: Pressione a tecla  para confirmar.</p>	 <p>Parâmetro 4 Temperatura ambiente</p>
<p>Passo 4: Pressionando a tecla  ou  introduza o valor da temperatura anotada anteriormente. Uma vez introduzido o valor da temperatura, prima a tecla  para confirmar. O ecrã mostra alternadamente a nova temperatura e o valor de compensação resultante (por exemplo, de 22 a 24 °C).</p>	



O intervalo de compensação é + 5 °C / - 5 °C.

5 PARÂMETRO 5: AJUSTAR DO DIA DA SEMANA





















O radiador deve estar no modo AUTO.

MODO AUTO



O dia da semana é ajustado automaticamente ao configurar o dia, mês e ano atuais.

<p>Passo 1: Acesse ao menu do utilizador premindo continuamente a tecla . O parâmetro 1 é mostrado.</p>	
<p>Passo 2: Pressione sucessivamente as teclas  ou  até selecionar o parâmetro 5. O ecrã mostra alternadamente o dia, mês e ano. Pressione a tecla  para continuar.</p>	
<p>Passo 3: Pressione a tecla  ou  seleccione o ano atual. Pressione a tecla  para confirmar.</p>	
<p>Passo 4: Pressionando a tecla  ou  seleccione o mês atual. Pressione a tecla  para confirmar.</p>	
<p>Passo 5: Seleccione o dia atual, pressionando a tecla  ou . Pressione a tecla  para confirmar.</p>	
<p>Passo 6: Para finalizar, pressione a tecla .</p>	

6 PARÂMETRO 6: AJUSTE DE HORA



O radiador deve estar no modo AUTO.

MODO AUTO



Pode editar a hora e os minutos (formato de 24 horas).



<p>Passo 1: Aceda ao menu do utilizador premindo continuamente a tecla . O parâmetro 1 é mostrado.</p>	<p>Parâmetro 1</p>
<p>Passo 2: Pressione sucessivamente as teclas ou até selecionar o parâmetro 6. O ecrã mostra alternadamente a hora e os minutos. Pressione a tecla para continuar.</p>	<p>Parâmetro 6</p>
<p>Passo 3: Pressionando as teclas ou seleccione a hora. Pressione a tecla para confirmar.</p>	<p>HORA</p>
<p>Passo 4: Seleccione os minutos, pressionando as teclas ou . Pressione a tecla para confirmar.</p>	<p>MINUTOS</p>
<p>Passo 5: Para finalizar, pressione a tecla .</p>	

7 PARÂMETRO 7 PROGRAMAÇÃO

O seu radiador pode ser operado manualmente ou automaticamente (com programação).

Levando em conta as suas necessidades, sensação de conforto, orientação e permanência na casa, o radiador oferece-lhe a possibilidade de criar um programa individual.

Tem 3 opções para programar o seu radiador: “dAY” / “PArT” / “ALL”.

OPÇÕES	EXPLICAÇÃO DO PROGRAMA
<p>OPÇÃO “DAY”</p> 	<p>Não tem uma rotina diária? Cada dia da semana é diferente? Escolha a opção “DAY” para configurar um programa diferente para cada dia da semana. Se a sua rotina diária é diferente para cada dia da semana, recomendamos esta opção.</p>
<p>OPÇÃO “PART”</p> 	<p>A sua rotina diária repete-se de segunda a sexta-feira?</p> <p>A sua rotina é a mesma durante o fim-de-semana? Escolha a opção “PART” se deseja uma programação de segunda a sexta e outra diferente para o fim-de-semana.</p>
<p>OPÇÃO “ALL”</p> 	<p>Escolha a opção “ALL” se deseja a mesma programação para todos os dias da semana. Esta opção é ideal para usuários que têm a mesma rotina diária durante toda a semana.</p>













Por defeito, o horário semanal definido de fábrica é:

- **De segunda a sexta-feira:**

O radiador funciona no modo conforto das 6h às 9h, das 12h às 14h e das 18h às 23h. No resto das horas, o radiador estará em modo economia.





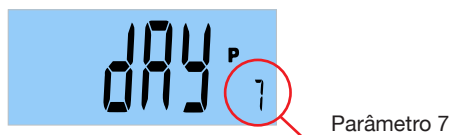

- **De Sábado a Domingo:**

O radiador funciona em modo conforto das 8h às 23h. No resto das horas, o radiador estará no modo economia

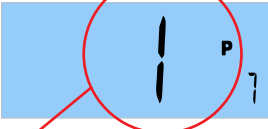
<p>Passo 1: Acesse ao menu do utilizador premindo continuamente a tecla . O parâmetro 1 é mostrado.</p>	 <p>Parâmetro 1</p>
<p>Passo 2: Pressione a tecla sucessivamente  ou  até selecionar o parâmetro 7. O ecrã mostra PROG. Pressione a tecla  para continuar.</p>	 <p>Parâmetro 7</p>
<p>Passo 3: Pressionando a tecla  ou  e com base na tabela anterior, selecione uma das três opções para programar o seu radiador. Pressione a tecla  para confirmar a opção pretendida.</p>	
<p>Passo 4:</p> <ul style="list-style-type: none"> • Se escolheu a opção “dAY”, continue na página 138. • Se escolheu a opção “PART”, continue na página 141. • Se escolheu a opção “dAY”, continue na página 144. 	

7.1 Se escolheu a opção de programação “dAY”:



<p>Passo 5: Pressione a tecla  para começar a configurar esta opção. Irá aparecer dia 1 (1 = Segunda-feira). A programação começa no primeiro dia da semana e às 00 h.</p>	
<p>Passo 6: Para passar de um dia para outro pressione a tecla  ou  :</p> <p>1 = Segunda-feira, 2 = Terça-feira, 3 = Quarta-feira, 4 = Quinta-feira, 5 = Sexta-feira, 6 = Sábado, 7 = Domingo</p>	
<p>Passo 7: Depois de escolher o dia da semana, pressione  para confirmar.</p> <p>O ecrã indica 00 h (12 da noite) do dia da semana escolhido e no modo ECONOMIA.</p> <p>Em seguida, seleccione um modo de operação hora a hora:</p>	

3. FUNCIONAMENTO

P

Passo 8: Na primeira faixa horária, de 00 h a 01 h, pressione sucessivamente a tecla  para selecionar o modo de operação: Conforto, OFF, Anti-gelo ou Economia. Que modo de operação escolher?



MODO CONFORTO

Selecione **Modo CONFORTO** se durante o intervalo de tempo a divisão está ocupada.

Neste modo, o radiador irá funcionar de acordo com a temperatura de conforto escolhida no **parâmetro 1**.



MODO DESLIGADO

Por favor, selecione **Modo DESLIGADO** se no intervalo de tempo não precisa de aquecimento na divisão.



MODO ANTI-GELO

El modo **ANTIHIELO** se suele utilizar para largos periodos de ausencia en los que se quiere evitar problemas de congelación de tuberías.

En este modo, el radiador funcionará según la temperatura de antihielo elegida en el **parámetro 3**.



MODO ECONOMIA

O modo **ECONOMIA** é usado durante a noite ou em curtos períodos de ausência. Evita que a temperatura ambiente caia demasiado baixo.

Neste modo, o radiador irá operar de acordo com a temperatura de economia escolhida no **parâmetro 2**.

Passo 9: Uma vez escolhido o modo de operação para a faixa horária de 00:00 a 01:00h,

pressione a tecla  para passar a configurar a próxima faixa horária. Repita este processo hora a hora.

P



Pressione a tecla  ou  para percorrer cada faixa horária.

Passo 10: Na última faixa horária do dia, aparece no ecrã **END**.

Passo 11: Para confirmar a programação, pressione a tecla  .

Passo 12: Para sair do menu de programação, pressione a tecla  .

Uma vez que o programa de tempo tenha sido definido, o radiador irá responder ao programa definido se o **modo de operação escolhido é o modo AUTO**.



Pressione a tecla  duas vezes para sair do menu de programação, **SEM GUARDAR OS DADOS**.

3. FUNCIONAMENTO











P

7.2 Se escolheu a opção de programação “PArt”:



Poderá estabelecer dois períodos: de segunda a sexta-feira e de sábado a domingo.













A programação efetuada na segunda-feira repete-se até sexta-feira, e a programação efetuada no sábado repete-se no domingo.

<p>Passo 5: Pressione a tecla  para começar a configurar esta opção. O visor mostra 1 - 5 (de segunda a sexta-feira).</p>	
<p>Passo 6: Pressione a tecla  ou  para escolher a faixa horária de segunda a sexta-feira (1-5) ou a faixa horária de sábado a domingo (6-7).</p> <div data-bbox="263 734 532 853"></div> <div data-bbox="582 734 851 853"></div>	
<p>Passo 7: Depois de escolher o dia da semana, pressione  para confirmar. O ecrã indica 00 h (12 da noite) do primeiro dia da faixa horária escolhida e além disso, modo ECONOMIA.</p> <div data-bbox="347 1013 767 1212"><p>ECONOMIA</p><p>HORA</p></div>	
<p>Passo 8: Para a primeira faixa horária de 00:00 a 01:00 de segunda-feira, pressione sucessivamente a tecla  para escolher o modo de operação pretendido: Conforto, OFF, Anti-gelo ou Economia.</p>	
<p>Passo 9: Depois de escolher o modo de operação para a faixa horária de 00 h a 01 h, pressione  para mover para a próxima faixa horária. Repita este processo para cada faixa horária.</p>	

P

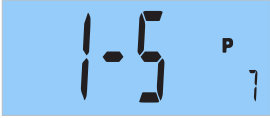

Pressione a tecla  ou  para percorrer cada faixa horária.

<p>Passo 10: Na última faixa horária do dia, aparece no ecrã END.</p>	
<p>Passo 11: Pressione a tecla  . A programação realizada na segunda-feira se repete até sexta-feira.</p>	
<p>Passo 12: Para iniciar a programação da faixa de sábado a domingo, pressione a tecla  .</p>	
<p>Passo 13: Pressione a tecla  ou  para escolher a opção Part novamente.</p>	
<p>Passo 14: Pressione a tecla  . É mostrado 1 -5 (de segunda-feira a sexta- feira).</p>	
<p>Passo 15: Pressione a tecla  ou  para seleccionar a faixa de sábado a domingo (6-7).</p>	

3. FUNCIONAMENTO

P

Passo 16: Pressione  para confirmar. O ecrã indica **00 h (12h da meia-noite) no sábado e além disso, modo ECONOMIA.**

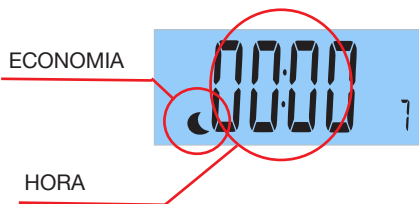

Passo 17: Depois de escolher o modo de operação para a faixa horária de 00 h a 01 h, pressione a tecla  para passar para a próxima faixa horária. Repita este processo para cada faixa horária.

Passo 18: Depois de escolher o modo de operação para a faixa horária de 00 h a 01 h, pressione a tecla  para passar para a próxima faixa horária. Repita este processo para cada faixa horária.

Passo 19: Na última faixa horária do dia, aparece no ecrã **END.**



Passo 20: Para sair do menu de programação, pressione a tecla . A programação realizada no sábado também é a mesma no domingo.



Pressione a tecla  duas vezes para sair do menu de programação, **SEM GUARDAR DADOS.**

P

7.3 Se escolheu a opção de programação “ALL”:



Pode definir o mesmo programa de segunda-feira a domingo. A programação da segunda-feira, se repete até domingo.

Passo 16: Pressione  para confirmar. O ecrã indica **00 h (12h da meia-noite) no sábado e também, modo ECONOMIA.**

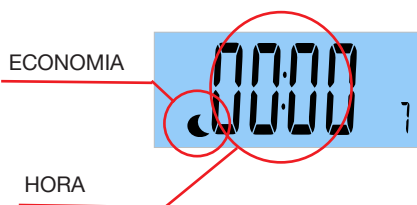

Passo 17: Para a primeira faixa horária de 00:00 a 01:00 de segunda-feira, pressione sucessivamente a tecla , para escolher o modo de operação pretendido: Conforto, OFF, Anti-gelo ou Economia.

Passo 18: Depois de escolher o modo de operação para a faixa horária de 00 h a 01 h, pressione a tecla  para passar para a próxima faixa horária. Repita este processo para cada faixa horária.

Passo 19: Na última faixa horária do dia, aparece no ecrã **END.**



Passo 20: Para sair do menu de programação, pressione a tecla . A programação realizada na segunda-feira se repete até domingo.

Uma vez configurada a programação, o radiador irá responder sempre que o **modo de operação escolhido é o modo AUTO.**



Pressione a tecla  duas vezes para sair do menu de programação, SEM GUARDAR DADOS.



IMPORTANTE: Cancelamento temporário de um programa em curso

Esta função permite alterar temporariamente a temperatura do set-point até à próxima modificação programada de temperatura ou quando tiverem decorrido mais de 2 horas desde a modificação.

Passo 1: Com o radiador no modo Auto, pressione a tecla  ou  para modificar temporariamente a temperatura de set-point.

Passo 2: Pressione  para confirmar.

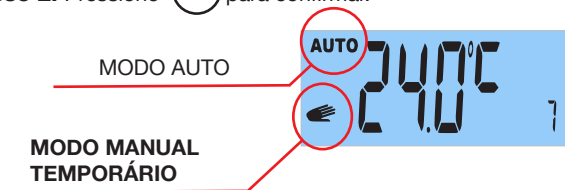

Esta alteração será automaticamente cancelada na próxima modificação de programa ou quando tiverem decorrido mais de 2 horas desde a modificação.















IMPORTANTE:

- O radiador irá responder de acordo ao modo de funcionamento (Conforto / Economia / Anti-gelo / Desligado) mostrado no ecrã.
- Não esqueça que o radiador deve estar em modo AUTO para que a programação configurada seja realizada.
- Pode sempre modificar as temperaturas designadas para o modo Conforto, Economia ou Anti-gelo, modificando o parâmetro 1, o parâmetro 2 ou o parâmetro 3, respetivamente.
- A temperatura mostrada no ecrã é a temperatura configurada no modo de operação em curso.
- O símbolo  irá aparecer sempre que a resistência do aparelho esteja a funcionar.

8 PARÂMETRO 8: FUNÇÃO ECONOMIA “JANELAS ABERTAS”

Esta função é ativada quando ocorre uma queda brusca da temperatura na divisão. Ao fechar a janela, o radiador irá detetar um aumento de temperatura e o radiador irá aquecer novamente, voltando ao estado antes de desligar.

Esta função inteligente é ativada como padrão. Pode ser desativada, se desejar.

<p>Passo 1: Acesse ao menu do utilizador premindo continuamente a tecla . O parâmetro 1 é mostrado.</p>	
<p>Passo 2: Pressione sucessivamente a tecla  ou  até que o parâmetro 8 seja selecionado. Pressione a tecla  para confirmar.</p>	
<p>Passo 3: Pressione a tecla  ou  para ativar ou desativar a função. Pressione a tecla  para confirmar.</p> <div style="display: flex; justify-content: space-around; align-items: center;"> <div data-bbox="240 957 509 1077" style="text-align: center;">  <p>Função Ativada</p> </div> <div data-bbox="610 957 879 1077" style="text-align: center;">  <p>Função Desabilitada</p> </div> </div>	
<p>Passo 4: Para sair do menu de programação, pressione a tecla .</p>	













Pressione a tecla  duas vezes para sair do menu de programação, **SEM GUARDAR DADOS**.

9 PARÂMETRO 9: FUNÇÃO INTELIGENTE “ITCS”

O radiador incorpora um **sistema inovador de controlo inteligente de temperatura ITCS**.

Este sistema ativa o aparelho **antes da hora programada** (máximo de 2 horas), para assegurar que se consegue a temperatura pretendida à hora indicada e seguindo o programa semanal estabelecido.

Esta função inteligente é ativada como padrão. Pode ser desativada, se desejar.

<p>Passo 1: Acesse ao menu do utilizador premindo continuamente a tecla. O parâmetro 1 é mostrado.</p>	 <p>Parâmetro 1</p>
<p>Passo 2: Pressione sucessivamente a tecla  ou  até que o parâmetro 9 seja selecionado. Pressione a tecla  para confirmar.</p>	 <p>Parâmetro 9</p>
<p>Passo 3: Pressione a tecla  ou  para ativar ou desativar a função. Pressione a tecla  para confirmar.</p> <div style="display: flex; justify-content: space-around; align-items: center;"> <div style="text-align: center;">  <p>Função Ativada</p> </div> <div style="text-align: center;">  <p>Função Desabilitada</p> </div> </div>	
<p>Passo 4: Para sair do menu de programação, pressione a tecla .</p>	



Pressione a tecla  duas vezes para sair do menu de programação, SEM GUARDAR DADOS.

10 PARÂMETRO 10: FUNÇÃO “INDICADOR DE CONSUMO”

O radiador incorpora uma função única no mercado que permite conhecer o seu consumo de eletricidade nas últimas 24 horas, nos últimos 7 dias e nos últimos 30 dias.



- **Importante:** Antes de conhecer o consumo de energia, deve introduzir o valor da potência do seu radiador (ver página 153).
- O radiador memoriza os dados de consumo a cada 4 horas.

<p>Passo 1: Aceda ao menu do utilizador premindo continuamente a tecla . O parâmetro 1 é mostrado.</p>	
<p>Passo 2: Pressione sucessivamente a tecla ou até que o parâmetro 10 seja selecionado. Pressione a tecla para confirmar.</p>	
<p>O ecrã mostra alternadamente o consumo (em KWh) durante as últimas 24 horas:</p>	
<p>Consumo em KWh</p>	
<p>Passo 3: Pressione a tecla sucessivamente ou para conhecer o consumo de eletricidade durante os últimos 7 dias e os últimos 30 dias.</p>	
<p>Passo 4: Para sair do menu, pressione a tecla duas vezes .</p>	



Na opção “consumo de 24 horas” pode saber o consumo total do radiador a partir do primeiro dia de operação, pressionando continuamente a tecla



11 PARÂMETRO 11: END

Passo 1: Chegou ao fim do menu do utilizador.



Passo 2: Pressione a tecla  para sair do menu do utilizador.

3.6 MENU AVANÇADO

Com este menu pode aceder e ajustar os seguintes parâmetros:

- **1:** SELEÇÃO DE GRAUS CELSIUS °C ou FARENHEIT °F.
- **2:** ATIVAR ou DESATIVAR A FUNÇÃO “FIL PILOTE” (para a França). Requer quadro distribuidor (não incluso).
- **3:** INDICAÇÃO DA VERSÃO DO SOFTWARE.
- **4:** AJUSTE DO VALOR DA POTÊNCIA DO RADIADOR.
- **5:** FUNÇÃO RESET.
- **6:** FIN MENU AVANÇADO

3.6.1 COMO ACEDER AO MENU AVANÇADO?

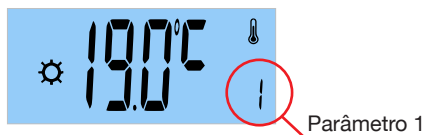

Passo 1: Pressione e segure a tecla . Irão aparecer no ecrã faixas horizontais e depois o parâmetro 1 “Seleção de Temperatura de Conforto” será mostrado.



Passo 2: Pressione sucessivamente as teclas  ou  até escolher o **parâmetro 11 “END”**.



Passo 3: Pressione e segure a tecla . novamente. Irão aparecer no ecrã faixas horizontais. Seguidamente o **parâmetro 1** é mostrado, “**ESCOLHA GRAUS CELSIUS °C / FARENHEIT °F**”.

Passo 4: Pressione a tecla  ou  para seleccionar o parâmetro avançado a ser modificado.

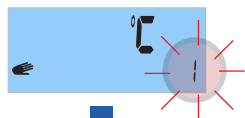
**PARÂMETRO 1
SELEÇÃO °C ou °F**

Pressione

**PARÂMETRO 2
SELEÇÃO "FIL PILOTE"
(apenas para a França)**

Pressione

**PARÂMETRO 3:
VERSÃO DO
SOFTWARE**

Pressione

**PARÂMETRO 6
FIM DO MENU AVANÇADO**

Pressione

**PARÂMETRO 5
FUNÇÃO "RESET"**

Pressione

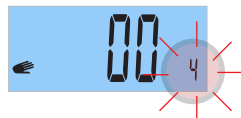







**PARÂMETRO 4
SELEÇÃO DE POTÊNCIA
DO RADIADOR**

3. FUNCIONAMENTO

P





1 PARÂMETRO 1: SELECIONAR GRAUS CELSIUS / FARENHEIT

Selecione graus Celsius (°C) ou graus Fahrenheit (°F).

Passo 1: Acesse ao menu avançado.	
Passo 2: Pressione a tecla  para confirmar.	
Passo 3: Pressione a tecla  ou  para escolher °C ou °F. Pressione a tecla  para confirmar.	
Passo 4: Pressione a tecla  ou  para selecionar outro parâmetro avançado ou pressione a tecla  para sair do menu avançado.	



2 PARÂMETRO 2: SELEÇÃO DA FUNÇÃO “FIL PILOTE” (apenas para França e requer quadro distribuidor (não incluído)).

Esta função é operacional apenas na França. Para ativar ou desativar esta função, siga os passos abaixo:

Passo 1: Acesse ao menu avançado. Com a tecla  ou  selecione 2.	
Passo 2: Pressione a tecla  para confirmar.	
Passo 3: Pressione a tecla  ou  para escolher Yes (Sim) ou No (Não). Pressione a tecla  para confirmar.	
Passo 4: Pressione a tecla  ou  para selecionar outro parâmetro avançado ou pressione a tecla  para sair do menu avançado.	

A função “Fil Pilote” funciona apenas no modo MANUAL.

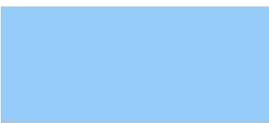
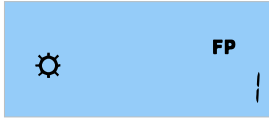
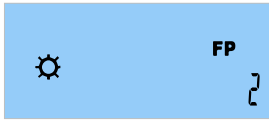
Uma vez seleccionada a temperatura em modo manual, os diferentes comandos do “Fil Pilote” actuam da seguinte forma:

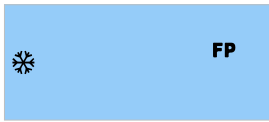
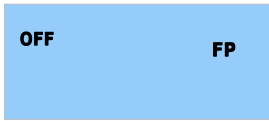





COMANDO “FIL PILOTE”	ECRÃ
Conforto (Não há comando)	
Conforto - 1°	
Conforto - 2°	
Economia	
Anti-gelo	
OFF	

3. FUNCIONAMENTO

P











3 PARÂMETRO 3: VERSÃO DO SOFTWARE

Indica a versão atual do software do seu radiador.

<p>Passo 1: Acesse ao menu avançado. Com a tecla  ou  selecione 3.</p>	
<p>Passo 2: A versão do software do seu radiador é mostrada.</p>	
<p>Passo 3: Pressione a tecla  ou  para selecionar outro parâmetro avançado ou pressione a tecla  para sair do menu avançado.</p>	

4 PARÂMETRO 4: SELECIONE A POTÊNCIA DO SEU RADIADOR

Para que o parâmetro 10 “indicador de consumo” funcione corretamente, é necessário introduzir o valor de potência do seu radiador. **A potência (watts) é indicada na etiqueta cinza localizada no lado direito do radiador ao lado do cabo de alimentação.**





<p>Passo 1: Acesse ao menu avançado. Com a tecla  ou  selecione 4.</p>	
<p>Passo 2: Pressione a tecla  para confirmar.</p>	
<p>Passo 3: Pressione a tecla  ou  para selecionar a potência do seu radiador (por exemplo 1000 W). Pressione a tecla  para confirmar.</p>	
<p>Passo 4: Pressione a tecla  ou  para selecionar outro parâmetro avançado ou pressione a tecla  para sair do menu avançado.</p>	

P

5 PARÂMETRO 5: “RESET”

Este parâmetro permite:

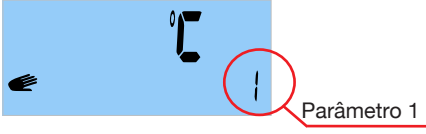
- Apagar a programação do radiador.
- Limpar todos os parâmetros, exceto a potência do seu radiador (parâmetro avançado 4, página 153).

<p>Passo 1: Acesse ao menu avançado. Com a tecla  ou  selecione 5.</p>	
<p>Passo 2: Para redefinir o radiador para os valores de fábrica, pressione e segure a tecla .</p>	
<p>Passo 3: O processo de “reinicialização” do seu radiador irá começar.</p> <p>Terminado o processo de “reset”, o radiador irá voltar para o modo manual com a temperatura pré-definida de fábrica (20 °C).</p> <p>Em seguida, escolha o modo de operação pretendido. Se escolher o modo AUTO, deve definir a hora e o dia atuais. Reprograme o seu radiador e defina os parâmetros pretendidos.</p>	

6 PARÂMETRO 6: END

<p>Passo 1: Chegou ao fim do menu avançado.</p>	
<p>Passo 2: Pressione a tecla  ou  para sair do menu avançado.</p>	

3. FUNCIONAMENTO

P

3.7 FUNÇÃO “BLOQUEIO DE TECLADO”

Pressione as teclas  e  simultaneamente até que o display mostre o **símbolo de uma chave**.



Repita a mesma operação para desbloquear o teclado até que o símbolo da chave desapareça.



Se houver uma falha de energia com a função “ bloqueio do teclado” ativada, o radiador irá continuar com o bloqueio do teclado ativado.

3.8 MENSAGEM DE ERRO “ERR”

Se “Err” estiver a piscar no ecrã, o sensor do seu termóstato está desligado ou é defeituoso. Consulte o nosso serviço pós-venda Haverland.



4. MANUTENÇÃO

O seu equipamento não requer qualquer manutenção especial.

Limpe apenas o pó que pode acumular-se usando um pano seco e macio.

É conveniente ao iniciar a temporada de inverno, limpar o pó acumulado na superfície do radiador.



NUNCA UTILIZE SOLVENTES OU PRODUTOS ABRASIVOS.

P

GARANTÍA

MARSAN INDUSTRIAL, S.A. garantiza la conformidad de los aparatos con las especificaciones del contrato.

Esta garantía cubre la reparación del aparato y comprenderá los gastos necesarios realizados para subsanar la falta de conformidad de los bienes con el contrato.

Dicha subsanación será garantizada durante un plazo de 36 meses desde la fecha de compra conforme a la factura contra cualquier defecto de fabricación y funcionamiento durante el uso normal y doméstico de este producto.

La estanqueidad del cuerpo de aluminio será garantizado durante un plazo de 10 años desde la fecha de compra conforme a la factura.

Esta garantía ampara únicamente el aparato cuyo modelo esté anotado en la factura de compra.

Esta garantía NO CUBRE la instalación inadecuada, el mantenimiento, limpieza o conservación del aparato, así como tampoco las averías motivadas por fuerza mayor, agentes químicos o fenómenos atmosféricos, por uso indebido del aparato, por una instalación eléctrica del comprador defectuosa, transporte del aparato, ni por la manipulación del aparato por personal no autorizado por MARSAN INDUSTRIAL, S.A.

Esta garantía no debe ser modificada, alterada ni extendida, y el Fabricante NO autoriza a nadie a actuar en su nombre en la modificación, alteración o extensión de ésta.

Esta garantía se aplica al Producto solamente.

Para la reparación del aparato, el consumidor deberá dirigirse al Servicio de Asistencia Técnica al teléfono 91 324 40 60 (Horario: Lunes a Viernes de 9 a 20 h) o enviar un correo electrónico a postventa@haverland.com solicitando la información necesaria sobre el procedimiento a seguir.

Para la sustitución, cancelación o rebaja del precio, en su caso, el consumidor deberá dirigirse al establecimiento vendedor. Esta garantía no afecta a los derechos de que dispone el consumidor conforme a las previsiones dispuestas en la Ley 23/2003, de Garantía en la Venta de Bienes de Consumo.



Teléfono Atención al Cliente:
91 324 40 60 (L-V: 9 - 20 h)



E-mail: postventa@haverland.com



La presencia de este símbolo sobre alguno de nuestros productos eléctricos o embalajes de presentación, significa que tales productos no deben tratarse como residuos domésticos convencionales en Europa. Para garantizar el tratamiento adecuado de este tipo de residuos, deshágase de los mismos conforme a las leyes pertinentes o según los requisitos de desecho de equipamiento eléctricos. Al tomar esta iniciativa, estará ayudando a preservar el medio ambiente.

Marsan Industrial, S.A.
Avda. San Martín de Valdeiglesias, Km. 2,2
28925 Alcorcón (Madrid)
España

Fabricado en España

Marsan Industrial, S.A. se reserva el derecho a realizar modificaciones sin previo aviso

GUARANTEE

MARSAN INDUSTRIAL, S.A. guarantees that the devices comply with the contracted specifications.

This warranty only covers the model of heater showed on the valid invoice.

Such rectifications will be guaranteed against any manufacturing and operating defect for the normal and domestic use of this product, for a period of 24 months as from the purchase date shown on the invoice.

HAVERLAND guarantees against material, design or manufacturing faults at the moment of its original acquisition for 2 years. The electronic component and paintwork / finish for 3 years and 10 years for the aluminium body (exclude accidental damage, transport, and misuse).

This warranty only covers the device whose model appears on the purchase invoice.

This warranty DOES NOT COVER incorrect installation, maintenance, cleaning or conserving the device, and neither does it cover failures and faults due to force major, chemical agents or atmospheric phenomena, incorrect use of the device, the purchaser's faulty electrical installations, transporting the device or problems caused by the device being handled by persons not authorised by MARSAN INDUSTRIAL, S.A.

This warranty must not be modified, altered or extended, and the Manufacturer does not authorise anybody to act on his behalf to modify, alter or extend it.

This warranty applies only to the Product.

To repair the device, the consumer must dial the Technical Assistance Service at 0330 3651940 or send an email to haverland@haverland.co.uk and ask for the information needed about the procedure to follow:

For a replacement, cancellation or price reduction, when in order, the consumer must go the establishment where the device was purchased. This warranty does not affect the consumers' rights as established in the provisions contained In Law 23/2003, the Consumer Goods Sales Guarantee Act.



Customer Service Telephone:

0330 3651940



E-mail: haverland@haverland.co.uk



Where you see this symbol on any of our electrical products or packaging, it indicates that the relevant electrical product should not be disposed of as general household waste in Europe. To ensure the correct waste treatment of the product, please dispose of it in accordance with any applicable local laws or requirements for disposal of electrical equipment. In so doing, you will help to conserve natural resources and improve standards of environmental protection in treatment and disposal of electrical waste.

Haverland UK Limited
Challenge House
Sherwood Drive
Bletchley MK3 6DP

Made in Spain

Marsan Industrial, S.A. reserves the right to modify without previous warning

GARANTIE

MARSAN INDUSTRIAL, S.A. garantit que les appareils sont conformes aux spécifications du contrat.

Cette garantie couvre la réparation de l'appareil et comprendra les charges nécessaires encourues pour corriger la non-conformité des biens avec le contrat.

Cette correction sera garantie sur une durée de 24 mois après la date d'achat, selon la facture, contre tout défaut de fabrication et de fonctionnement au cours de l'usage normal et domestique de ce produit.

Le coût du matériel (pièces et pièces de rechange) sera garanti pendant une période de 36 mois et l'étanchéité du corps en aluminium, pendant 10 ans après la date d'achat selon la facture.

Cette garantie ne couvre que l'appareil dont le modèle est annoté sur la facture d'achat.

Elle NE COUVRE PAS l'installation incorrecte, l'entretien, le nettoyage ou la conservation de l'appareil, ni les pannes motivées par une cause de force majeure, des agents chimiques ou des phénomènes atmosphériques, par un usage indu de l'appareil, par une installation électrique de l'acheteur défectueuse, par le transport de l'appareil, ni par la manipulation de l'appareil par un personnel non agréé par MARSAN INDUSTRIAL, S.A.

Cette garantie ne doit être ni modifiée ni altérée ni étendue, et le Fabricant n'autorise personne à agir en son nom dans la modification, l'altération ou l'extension de celle-ci.

Cette garantie s'applique uniquement au Produit.

Pour la réparation de l'appareil, le consommateur devra s'adresser au Service d'Assistance Technique en contactant le + 34 91 324 40 60 (Horaire : du lundi au vendredi, de 9 h à 20 h) ou envoyer un email à postventa@haverland.com en sollicitant l'information nécessaire de la démarche à suivre.

Pour demander une substitution, une annulation ou un rabais, le cas échéant, le consommateur devra s'adresser à l'établissement vendeur. Cette garantie n'affecte pas les droits dont dispose le consommateur selon la Loi 23/2003, de Garantie dans la Vente de Biens de Consommation.



Téléphone Service Client:

+ 34 91 324 40 60 (L-V: 9 - 20 h)



E-mail: postventa@haverland.com



Quand vous voyez ce symbole sur l'un de vos produits électriques ou sur l'emballage, ceci veut dire que le produit électrique en question ne doit pas être jeté avec les ordures ménagères ordinaires en Europe. Pour garantir le traitement correct du produit en tant que déchet, veuillez vous en défaire conformément à la législation locale applicable ou aux prescriptions relatives à l'élimination des équipements électriques. De cette façon, vous aiderez à préserver de l'environnement.



Fabriqué en Espagne

Marsan Industrial, S.A.
Avda. San Martín de Valdeiglesias, Km. 2,2
28925 Alcorcón (Madrid)
Espagne

Fabriqué en Espagne

Marsan Industrial, S.A. se réserve le droit de réaliser des modifications sans avis préalable.

GARANTIA

A MARSAN INDUSTRIAL, S.A. garante a conformidade dos aparelhos com as especificações do contrato.

Esta garantia cobre a reparação do aparelho e compreende as despesas necessárias e realizadas para resolver a falta de conformidade dos bens com o contrato.

Esta resolução será garantida durante um prazo de 36 meses desde a data de compra segundo a fatura contra qualquer defeito de fabrico e funcionamento durante uma utilização normal e doméstica deste produto.

A estanquidade do corpo de alumínio será garantido durante um prazo de 10 anos a partir da data de compra segundo a factura.

Esta garantia cobre unicamente o aparelho cujo modelo seja indicado na factura de compra.

Esta garantia NÃO COBRE uma instalação inadequada, a manutenção, a limpeza ou conservação do aparelho, as avarias causadas por força maior, agentes químicos ou fenómenos atmosféricos, por utilização indevida do aparelho, por instalação eléctrica do comprador defeituosa, por transporte do aparelho nem pela manipulação do aparelho por pessoal não autorizado pela MARSAN INDUSTRIAL, S. A.

Esta garantia não deve ser modificada, alterada nem ampliada e o Fabricante não autoriza ninguém a agir em seu nome para a modificação, alteração ou ampliação da mesma. Esta garantia aplica-se unicamente ao produto.

Para a reparação do aparelho, o consumidor deve contactar o Serviço de Assistência Técnica através do telefone + 34 91 324 40 60 (Horário: segunda a sexta das 09h00 às 20h00) ou enviar um correio electrónico para postventa@haverland.com, pedindo a informação necessária sobre o procedimento a seguir.

Para a substituição, anulação ou redução do preço, consoante o caso, o consumidor deve contactar o estabelecimento vendedor. Esta garantia não afeita os direitos do consumidor em conformidade com o disposto na Lei 23/2003, sobre a Garantia na Venda de Bens de Consumo.



Apoio ao Cliente:

+ 34 91 324 40 60 (L-V: 9 - 20 h)



E-mail: postventa@haverland.com



Quando encontra este símbolo em qualquer um dos nossos produtos eléctricos ou na respectiva embalagem isso indica que na Europa esse produto eléctrico não deve ser deitado fora juntamente com o lixo doméstico normal. Para assegurar o devido tratamento ecológico deste produto quando o deite fora, é favor acuar em conformidade com as leis ou regulamentos locais aplicáveis para a eliminação de equipamento eléctrico. Se assim o fizer contribui para a protecção ambiental.



Marsan Industrial, S.A.
Avda. San Martín de Valdeiglesias, Km. 2,2
28925 Alcorcón (Madrid)
Espanha

Fabricado em Espanha

Marsan Industrial, S.A. reserva-se o direito de realizar modificações sem aviso prévio

Modelos / Models / <i>Modèles / Modelos</i>	RCE4S_LCD	RCE6S_LCD	RCE8S_LCD	RCE10S_LCD	RCE12S_LCD
Potencia calorífica / Heat output / <i>Puissance thermique / Potência calorífica</i>					
Potencia calorífica nominal (kW) Nominal heat output (kW) <i>Puissance thermique nominale (kW)</i> <i>Potência calorífica nominal (kW)</i>	0.6	0.9	1.2	1.5	1.8
Potencia calorífica máxima continuada (kW) Maximum continuous heat output (kW) <i>Puissance thermique maximale continue (kW)</i> <i>Potência calorífica contínua máxima (kW)</i>	0.6	0.9	1.2	1.5	1.8
Consumo auxiliar de electricidad / Auxiliary electricity consumption / <i>Consommation d'électricité auxiliaire / Consumo de eletricidade auxiliar</i>					
A potencia calorífica nominal (kW) At nominal heat output (kW) <i>À la puissance thermique nominale (kW)</i> <i>À potência calorífica nominal (kW)</i>	0.6	0.9	1.2	1.5	1.8
A potencia calorífica mínima (kW) At minimum heat output (kW) <i>À la puissance thermique minimale (kW)</i> <i>À potência calorífica mínima (kW)</i>	0.6	0.9	1.2	1.5	1.8
En modo de espera (kW) In standby mode (kW) <i>En mode veille (kW)</i> <i>Em estado de vigília (kW)</i>	<0,001.	<0,001.	<0,001.	<0,001	<0,001
Tipo de control de temperatura interior Type of heat room temperature control <i>Type de contrôle de la température de la pièce</i> <i>Tipo de comando da temperatura interior</i>	Con control electrónico de temperatura interior y temporizador semanal Electronic room temperature control plus week timer <i>Contrôle électronique de la température de la pièce et programmeur hebdomadaire</i> <i>Com comando eletrônico da temperatura interior e temporizador semanal</i>				
Otras opciones de control	- Control de temperatura interior con detección de ventanas abiertas - Con control de puesta en marcha adaptable				
Other control options	- Room temperature control, with open window detection - With adaptive start control				
<i>Autres options de contrôle</i>	- <i>Contrôle de la température de la pièce, avec détecteur de fenêtre ouverte</i> - <i>Contrôle adaptatif de l'activation</i>				
<i>Outras opções de comando</i>	- <i>Comando da temperatura interior, com deteção de janelas abertas</i> - <i>Com comando de arranque adaptativo</i>				
Nombre del fabricante / Name del fabricante / <i>Nom du fabricant / Nome do fabricante</i>	Marsan Industrial, S.A.				
Dirección / Address / <i>Adresse / Endereço</i>	Avda. San Martín de Valdeiglesias, Km 2.2 28925 Alcorcón (Madrid) <i>España / Spain / Espagne / Espanha</i>				

RCES_LCD

	W	Nº 
RCE4S_LCD	600	4
RCE6S_LCD	900	6
RCE8S_LCD	1200	8
RCE10S_LCD	1500	10
RCE12S_LCD	1800	12

230 V 50 Hz
CLASE I /
CLASS I / CLASSE I