

MAX PLUS EP92

AAA



Specifications

Classification:	Alkaline
Chemical System:	Zinc-Manganese Dioxide (Zn/MnO ₂) No added mercury or cadmium
Designation:	ANSI-24A, IEC-LR03
Nominal Voltage:	1.5 volts
Nominal IR:	150 to 300 milliohms (fresh)
Operating Temp:	-18°C to 55°C (0°F to 130°F)
Typical Weight:	11.5 grams (0.4 oz.)
Typical Volume:	3.8 cubic centimeters (0.2 cubic inch)
Jacket:	Plastic Label
Shelf Life:	12 years at 21°C
Terminal:	Flat Contact

Industry Standard Dimensions

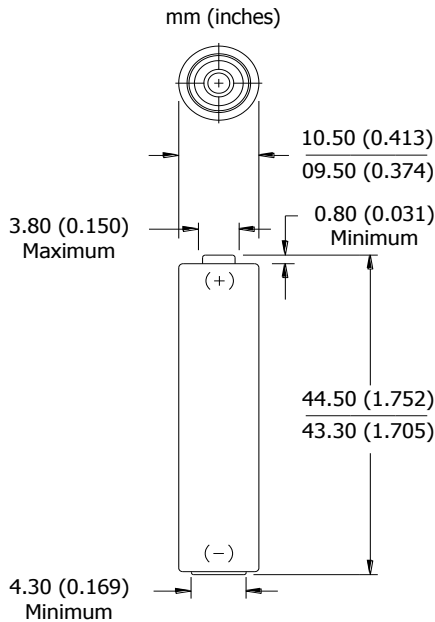

Milliamp-Hours Capacity

Continuous discharge to 0.8 volts at 21°C

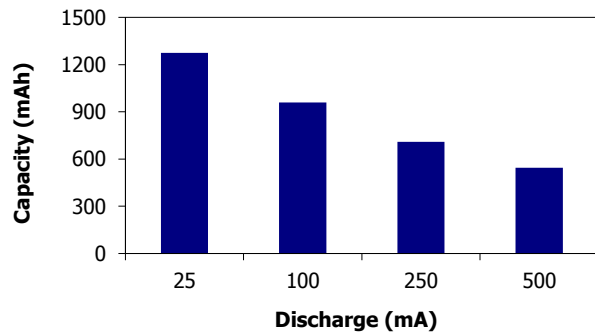

Industry Standard Tests (21°C)

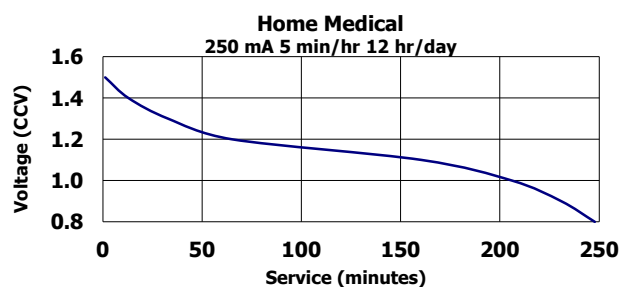
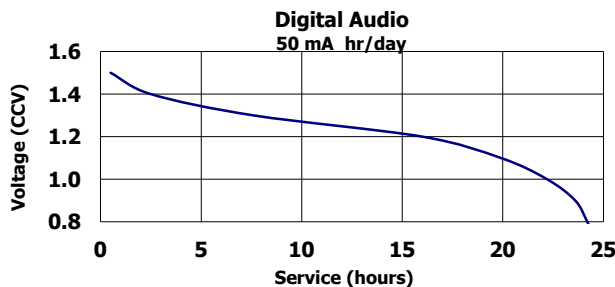
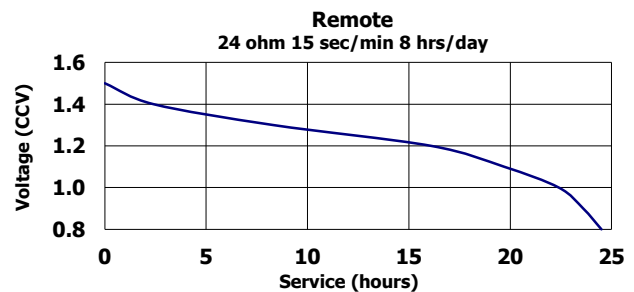
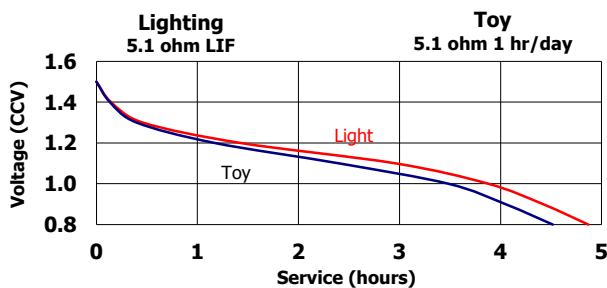

Important Notice

This datasheet contains typical information specific to products manufactured at the time of its publication. Contents herein do not constitute a warranty and are for reference only.