

EN
FR
DE
IT
ES
PT
NL

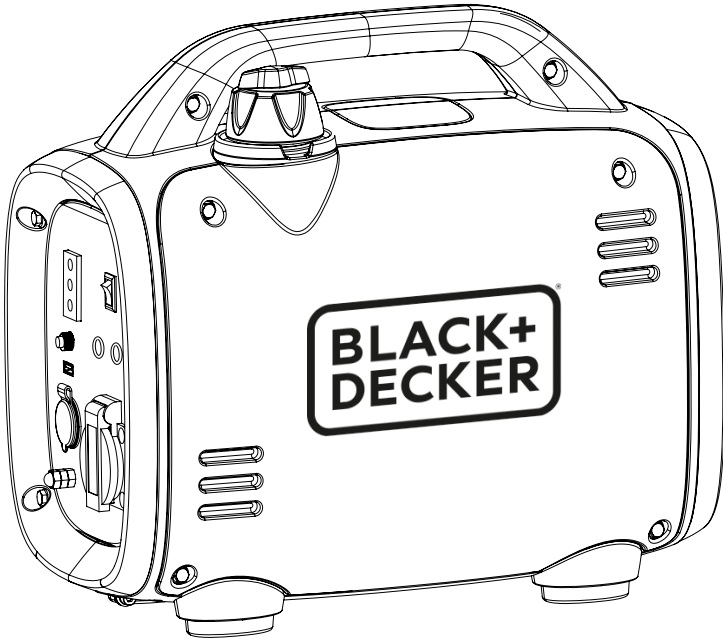

EN
FR
DE
IT
ES
PT
NL

Content
Contenu
Inhalt
Soddisfare
Contenido
Conteúdo
Inhoud



- 2** SAFETY /SÉCURITÉ / SICHERHEIT/ SICUREZZA / SEGURIDAD / SEGURANÇA / VEILIGHEID
- 8** MACHINE SETUP / CONFIGURATION DE LA MACHINE / MASCHINENEINRICHTUNG / CONFIGURAZIONE DELLA MACCHINA / PREPARACIÓN DE LA MÁQUINA / CONFIGURAÇÃO DA MÁQUINA / MACHINE SETUP
- 9** OIL LEVEL INSPECTION / CONTRÔLE DU NIVEAU D'HUILE / ÖLSTAND KONTROLLIEREN / CONTROLLO LIVELLO D'OLIO / INSPECCIÓN DEL NIVEL DE ACEITE / INSPEÇÃO DE NÍVEL DE ÓLEO / OLIEPEIL CONTROLERE
- 12** FUEL TANK FILLING / RAVITAILLEMENT / TANKEN / RABBOCCO / LLENADO DEL DEPÓSITO DE COMBUSTIBLE/ ENCHIMENTO DO TANQUE DE COMBUSTÍVEL / TANKEN
- 13** OPERATION - START/ FONCTIONNEMENT - START / BETRIEB - START / ESERCIZIO - START / OPERACIÓN - START / OPERAÇÃO - START / GEBRUIK - START
- 15** OPERATION / FONCTIONNEMENT / BETRIEB / ESERCIZIO / OPERACIÓN / OPERAÇÃO / GEBRUIK
- 16** OPERATION - OVERLOAD / FONCTIONNEMENT - PROTECTION CONTRE LA SURCHARGE / BETRIEB - ÜBERLASTSCHUTZ / ESERCIZIO - PROTEZIONE CONTRO I SOVRACCARICHI / OPERACIÓN - SOBRECARGA / OPERAÇÃO - SOBRECARGA / GEBRUIK - OVERBELASTINGSBEVEILIGING
- 17** OPERATION - STOP/ FONCTIONNEMENT - STOP / BETRIEB - STOP / ESERCIZIO - STOP / OPERACIÓN - STOP / OPERAÇÃO - STOP / WERKING - STOP
- 18** SPARK PLUG CHANGE / CHANGEMENT DE BOUGIE / ZÜNDKERZENWECHSEL / SOSTITUZIONE DELLE CANDELE / CAMBIO DE BUJÍA / TROCA DE VELA / BOUGIE VERVANGEN
- 19** OIL CHANGE / REMPLACEMENT D'HUILE / ÖLWECHSEL / CAMBIO DE L'OLIO / CAMBIO DE ACEITE / TROCA DE ÓLEO / OLIE VERVANGING
- 20** AIR FILTER / FILTRE À AIR / LUFTFILTER / FILTRO D'AIRA / FILTRO DE AIRE / FILTRO DE AR / LUCHTFILTER
- 21** FUEL FILTER / FILTRE À CARBURANT / KRAFTSTOFFFILTER / FILTRO CARBURANTE / FILTRO DE COMBUSTIBLE / FILTRO DE COMBUSTÍVEL / BRANDSTOFFILTE
- 22** TRANSPORT - STORAGE / TRANSPORT - STOCKAGE / TRANSPORT - LAGERUNG / TRANSPORTO - STOCCAGGIO / TRANSPORTE - ALMACENAJE / TRANSPORTE - ARMazenamento / TRANSPORT - BEWARING
- 23** TECHNICAL DATA / DONNÉES TECHNIQUES / TECHNISCHE DATEN / DATI TECNICI / DATOS TÉCNICOS / DADOS TÉCNICOS / TECHNISCHE DATA

SAFETY / SÉCURITÉ / SICHERHEIT / SICUREZZA / SEGURIDAD / SEGURANÇA / VEILIGHEID



- EN Perform a visual inspection of the external and internal components.
- FR **Effectuez une inspection visuelle des composants externes et internes.**
- DE Führen Sie eine Sichtprüfung der externen und internen Komponenten durch
- IT **Eseguire un'ispezione visiva dei componenti esterni e interni.**
- ES Realice una inspección visual de los componentes externos e internos.
- PT Realize uma inspeção visual dos componentes externos e internos.
- NL Voer een visuele inspectie uit van de externe en interne componenten.



- EN The temperature range for the use of this equipment is between + 5°C and + 40°C
- FR **La plage de température pour l'utilisation de cet équipement est comprise entre + 5°C et + 40°C**
- DE Der Temperaturbereich für die Verwendung dieses Geräts liegt zwischen + 5 ° C und + 40 ° C.
- IT **L'intervallo di temperatura per l'uso di questa apparecchiatura è compreso tra + 5 ° C e + 40 ° C.**
- ES El rango de temperatura para el uso de este equipo está entre +5°C y +40°C.
- PT A faixa de temperatura para o uso deste equipamento está entre + 5°C e + 40°C.
- NL Het temperatuurbereik voor het gebruik van deze apparatuur ligt tussen + 5°C en + 40°C.



- EN All items must be cleaned regularly.
- FR **Tous les articles doivent être nettoyés régulièrement.**
- DE Alle Gegenstände müssen regelmäßig gereinigt werden.
- IT **Tutti gli articoli devono essere puliti regolarmente.**
- ES Todos los elementos deben limpiarse regularmente.
- PT Todos os itens devem ser limpos regularmente.
- NL Alle items moeten regelmatig worden schoongemaakt.



- EN The air filter must be cleaned regularly.
- FR **Le filtre à air doit être nettoyé régulièrement.**
- DE Der Luftfilter muss regelmäßig gereinigt werden.
- IT **Il filtro dell'aria deve essere pulito regolarmente.**
- ES El filtro del aire debe ser limpiado regularmente.
- PT O filtro de ar deve ser limpo regularmente
- NL Het luchtfilter moet regelmatig worden schoongemaakt.

SAFETY / SÉCURITÉ / SICHERHEIT/ SICUREZZA / SEGURIDAD / SEGURANÇA / VEILIGHEID



- EN The exhaust gases contain carbon monoxide. This gas is colorless and colorless and is very dangerous. NEVER USE THE EQUIPMENT IN A LOCATION CLOSED OR WITH POOR VENTILATION.
- FR Les gaz d'échappement contiennent du monoxyde de carbone. Ce gaz est incolore et incolore et est très dangereux. NE JAMAIS UTILISER L'ÉQUIPEMENT DANS UN ENDROIT FERMÉ OU AVEC UNE MAUVAISE VENTILATION.
- DE Die Abgase enthalten Kohlenmonoxid. Dieses Gas ist farblos und farblos und sehr gefährlich. VERWENDEN SIE DAS GERÄT NIEMALS AN EINEM GESCHLOSSENEN STANDORT ODER MIT SCHLECHTER BELÜFTUNG.
- IT I gas di scarico contengono monossido di carbonio. Questo gas è incolore e incolore ed è molto pericoloso. NON UTILIZZARE MAI L'APPARECCHIATURA IN UN LUOGO CHIUSO O CON VENTILAZIONE SCARSA.
- ES Los gases del escape contienen monóxido de carbono. Este gas es inoloro e incoloro y es muy peligroso. NUNCA UTILICE EL EQUIPO E UN LUGAR CERRADO O CON POBRE VENTILACIÓN.
- PT Os gases de escape contém monóxido de carbono. Este gás é incolor e incolor e é muito perigoso. NUNCA USE O EQUIPAMENTO EM LOCAL FECHADO OU COM POUCA VENTILAÇÃO.
- NL De uitlaatgassen bevatten koolmonoxide. Dit gas is kleurloos en kleurloos en is zeer gevaarlijk. GEBRUIK DE APPARATUUR NOOIT OP EEN GESLOTEN LOCATIE OF MET SLECHTE VENTILATIE.



- EN The repair of the generator must be carried out by qualified and authorized personnel for this purpose
- FR La réparation du générateur doit être effectuée par du personnel qualifié et autorisé à cet effet
- DE Die Reparatur des Generators muss zu diesem Zweck von qualifiziertem und autorisiertem Personal durchgeführt werden
- IT La riparazione del generatore deve essere eseguita da personale qualificato e autorizzato a tale scopo
- ES La reparación del generador debe ser realizada por personal cualificado y autorizado para este fin
- PT O reparo do gerador deve ser realizado por pessoal qualificado e autorizado para esse fim.
- NL Hiervoor moet de reparatie van de generator worden uitgevoerd door gekwalificeerd en geautoriseerd personeel



- EN Store the generator in an area with good ventilation
- FR Stockez le générateur dans un endroit bien ventilé.
- DE Lagern Sie den Generator an einem Ort mit guter Belüftung.
- IT Conservare il generatore in un'area ben ventilata per questo scopo.
- ES Almacene el generador en un área con buena ventilación para este fin
- PT Armazene o gerador em uma área com boa ventilação.
- NL Bewaar de generator in een goed geventileerde ruimte

SAFETY / SÉCURITÉ / SICHERHEIT / SICUREZZA / SEGURIDAD / SEGURANÇA / VEILIGHEID



- EN The guarantee is automatically canceled if you do not follow the described start and stop process.
 - FR **La garantie est automatiquement annulée si vous ne suivez pas le processus de démarrage et d'arrêt décrit.**
 - DE Die Garantie erlischt automatisch, wenn Sie den beschriebenen Start- und Stoppvorgang nicht befolgen.
 - IT **La garanzia viene automaticamente annullata se non si segue il processo di avvio e arresto descritto.**
 - ES La garantía queda automáticamente anulada si no sigue el proceso descrito de arranque y paro
 - PT A garantia é cancelada automaticamente se você não seguir o processo de início e parada descrito.
 - NL De garantie wordt automatisch geannuleerd als u het beschreven start- en stopproces niet volgt
-



- EN Failure to follow the described process may damage the equipment. For this purpose
 - FR **Le non-respect du processus décrit peut endommager l'équipement.**
 - DE Die Nichtbeachtung des beschriebenen Vorgangs kann das Gerät beschädigen
 - IT **La mancata osservanza del processo descritto può danneggiare l'apparecchiatura A tale scopo**
 - ES No respetar el proceso descrito, puede dañar el equipo. para este fin
 - PT O não cumprimento do processo descrito pode danificar o equipamento.
 - NL Het niet opvolgen van de beschreven procedure kan de apparatuur beschadigen. Voor dit doeleinde
-



- EN Check the screws and nuts that due to the vibration of the equipment could loosen.
- FR **Vérifiez les vis et les écrous qui, en raison des vibrations de l'équipement, pourraient se desserrer.**
- DE Überprüfen Sie die Schrauben und Muttern, die sich aufgrund der Vibration des Geräts lösen könnten.
- IT **Controllare le viti e i dadi che a causa della vibrazione dell'attrezzatura potrebbero allentarsi.**
- ES Verifique los tornillos y tuercas que debido a la vibración del equipo podrían aflojarse.
- PT Verifique os parafusos e porcas que devido à vibração do equipamento podem afrouxar.
- NL Controleer de schroeven en moeren die door de trillingen van de apparatuur zouden kunnen loskomen.

SAFETY / SÉCURITÉ / SICHERHEIT / SICUREZZA / SEGURIDAD / SEGURANÇA / VEILIGHEID



- EN Good quality oil and fuel are imperatives for using the equipment.
- FR Une huile et un carburant de bonne qualité sont impératifs pour l'utilisation de l'équipement.
- DE Für die Verwendung der Geräte sind Öl und Kraftstoff von guter Qualität unerlässlich.
- IT **Olio e carburante di buona qualità sono indispensabili per l'utilizzo dell'attrezzatura.**
- ES Aceite y combustible de buena calidad son imperativos para el uso del equipo.
- PT Óleo e combustível de boa qualidade são imperativos para o uso do equipamento.
- NL **Olie en brandstof van goede kwaliteit zijn noodzakelijk voor het gebruik van de apparatuur.**



- EN Long-term storage should be done in a dry place. Frost can damage the equipment. Thoroughly dry equipment before storage and store in a dry, not cold place.
- FR **Le stockage à long terme doit être effectué dans un endroit sec. Le gel peut endommager l'équipement. Sécher soigneusement l'équipement avant le stockage et le stocker dans un endroit sec et non froid.**
- DE Die Langzeitlagerung sollte an einem trockenen Ort erfolgen. Frost kann die Ausrüstung beschädigen. Trocknen Sie die Geräte vor der Lagerung gründlich und lagern Sie sie an einem trockenen und nicht kalten Ort.
- IT **La conservazione a lungo termine deve essere effettuata in un luogo asciutto. Il gelo può danneggiare l'attrezzatura. Asciugare accuratamente l'attrezzatura prima di riporla e riporla in un luogo asciutto, non freddo.seco y no frío.**
- ES Un almacenaje de larga duración debe realizarse en lugar seco. Las heladas pueden dañar el equipo. Seque completamente el equipo antes del almacenaje y guárdelo en lugar seco y no frío.
- PT O armazenamento a longo prazo deve ser feito em local seco. Frost pode danificar o equipamento. Seque bem o equipamento antes de armazená-lo e guarde-o em local seco e não frio.seco y no frío.
- NL Langdurige opslag moet op een droge plaats gebeuren. Vorst kan de apparatuur beschadigen. Droog de apparatuur grondig voordat u ze opbergt en bewaar ze op een droge, niet koude plaats.



- EN Make sure all filters are cleaned regularly.
- FR **Assurez-vous que tous les filtres sont nettoyés régulièrement.**
- DE Stellen Sie sicher, dass alle Filter gereinigt sind regelmäßig
- IT **Assicurarsi che tutti i filtri siano puliti regolarmente.**
- ES Asegúrese que todos los filtros se limpian regularmente.
- PT Verifique se todos os filtros estão limpos regularmente.
- NL Zorg ervoor dat alle filters regelmatig worden schoongemaakt.

SAFETY / SÉCURITÉ / SICHERHEIT / SICUREZZA / SEGURIDAD / SEGURANÇA / VEILIGHEID

EN The exhaust temperature is high during use of the equipment and remains warm even after the generator is turned off. Be careful not to touch the hot exhaust and wait for the equipment to cool down before moving it.

FR La température d'échappement est élevée pendant l'utilisation de l'équipement et reste chaude même après l'arrêt du générateur. Veillez à ne pas toucher l'échappement chaud et attendez que l'équipement refroidisse avant de le déplacer.

DE Die Abgastemperatur ist während des Betriebs des Geräts hoch und bleibt auch nach dem Ausschalten des Generators warm. Achten Sie darauf, den heißen Auspuff nicht zu berühren, und warten Sie, bis sich das Gerät abgekühlt hat, bevor Sie es bewegen.



IT La temperatura di scarico è alta durante l'uso dell'apparecchiatura e rimane calda anche dopo lo spegnimento del generatore. Fare attenzione a non toccare lo scarico caldo e attendere che l'apparecchiatura si raffreddi prima di spostarla.

ES La temperatura del escape es elevada durante el uso del equipo y se mantiene caliente incluso una vez apagado el generador. Tenga cuidado de no tocar el escape caliente y espere a que se enfrie el equipo antes de moverlo.

PT A temperatura de exaustão é alta durante o uso do equipamento e permanece quente mesmo depois que o gerador é desligado. Cuidado para não tocar no escapamento quente e aguarde o equipamento esfriar antes de movê-lo.

NL De uitlaatgastemperatuur is hoog tijdens het gebruik van de apparatuur en blijft warm, zelfs nadat de generator is uitgeschakeld. Pas op dat u de hete uitlaat niet aanraakt en wacht tot de apparatuur is afgekoeld voordat u deze verplaatst.

EN Do not smoke and avoid flames and sparks when using the generator or when filling the tank. Do not store the generator near flammable material to avoid explosion hazard.

FR Ne fumez pas et évitez les flammes et les étincelles lors de l'utilisation du générateur ou lors du remplissage du réservoir. Ne stockez pas le générateur à proximité de matériaux inflammables pour éviter tout risque d'explosion.

DE Rauchen Sie nicht und vermeiden Sie Flammen und Funken, wenn Sie den Generator verwenden oder den Tank füllen. Lagern Sie den Generator nicht in der Nähe von brennbarem Material, um Explosionsgefahr zu vermeidende



IT Non fumare ed evitare fiamme e scintille quando si utilizza il generatore o quando si riempie il serbatoio. Non conservare il generatore vicino a materiale infiammabile per evitare il rischio di esplosione.de explosión.

ES No fume y evite las llamas y chispas durante el uso del generador o durante el llenado del depósito. No almacene el generador cerca de material inflamable para evitar peligro de explosión.para este fin

PT Não fume e evite chamas e faíscas ao usar o gerador ou ao encher o tanque. Não guarde o gerador próximo a material inflamável para evitar risco de explosão.

NL Rook niet en vermijd vlammen en vonken bij gebruik van de generator of bij het vullen van de tank. Bewaar de generator niet in de buurt van brandbaar materiaal om explosiegevaar te voorkomen.

SAFETY / SÉCURITÉ / SICHERHEIT/ SICUREZZA / SEGURIDAD / SEGURANÇA / VEILIGHEID

EN Never place the generator in an inclined or vertical position, to avoid fuel loss and equipment damage.

FR **Ne placez jamais le générateur en position inclinée ou verticale pour éviter les fuites de carburant et les dommages à l'équipement.**

DE Stellen Sie den Generator niemals in einer geneigten oder vertikalen Position auf, um Kraftstoffverlust und Geräteschäden zu vermeiden.



IT **Non posizionare mai il generatore in posizione inclinata o verticale, per evitare perdite di carburante e danni alle apparecchiature.**

ES Nunca coloque el generador en una posición inclinada o vertical, para evitar pérdidas de combustible y daños de equipo.

PT Nunca coloque o gerador em uma posição inclinada ou vertical, para evitar perda de combustível e danos ao equipamento.

NL Plaats de generator nooit schuin of verticaal om brandstofverlies en schade aan de apparatuur te voorkomen.

EN ALWAYS control the oil and fuel level, as well as its maintenance before each use

FR **TOUJOURS contrôler le niveau d'huile et de carburant, ainsi que son entretien avant chaque utilisation.**

DE Kontrollieren Sie IMMER den Öl- und Kraftstoffstand sowie die Wartung vor jedem Gebrauch.



IT **Controllare SEMPRE il livello di olio e carburante, nonché la sua manutenzione prima di ogni utilizzo.**

ES Controla SIEMPRE el nivel de aceite y combustible, así como sus mantenimientos antes de cada utilización.

PT SEMPRE controle o nível de óleo e combustível, bem como sua manutenção antes de cada uso.

NL Controleer ALTIJD het olie- en brandstofpeil en het onderhoud ervan voor elk gebruik

EN Machine setup
FR Préparation de la machine
DE Vorbereitung der Maschine
IT Preparazione della macchina
ES Preparación de la máquina
PT Preparação da máquina
NL Voorbereiding van de machine

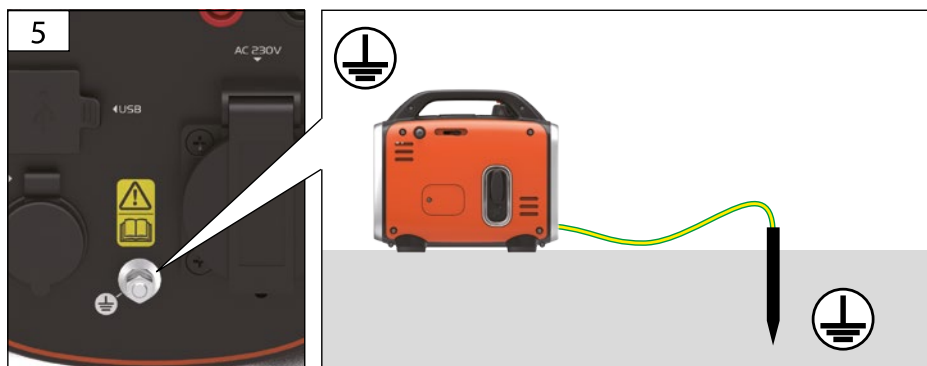
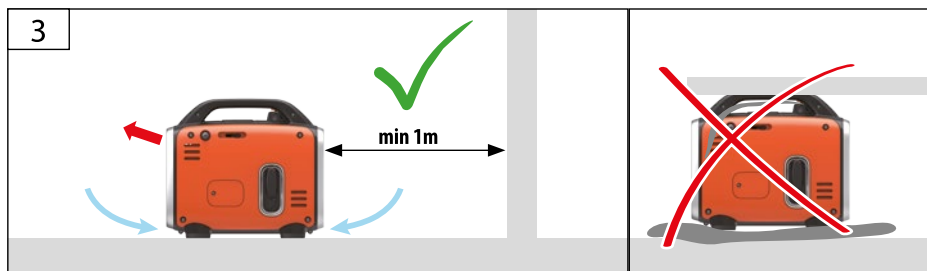
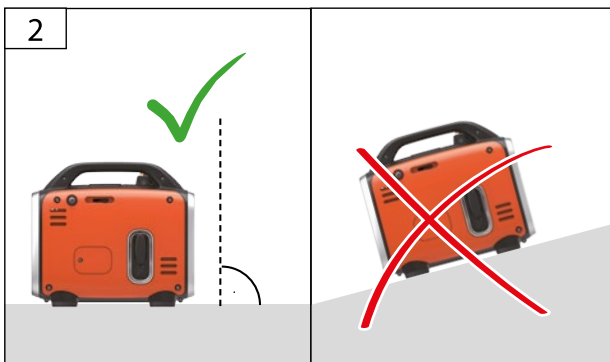
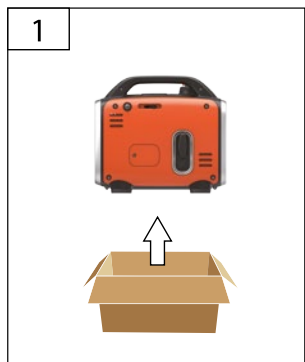

EN Oil level inspection
 FR Contrôle du niveau d'huile
 DE Ölstand kontrollieren
 IT Controllo livello d'olio
 ES Inspección del nivel de aceite
 PT Inspeção de nível de óleo
 NL Oliepeil controleren



5W-30
10W-30

EN Check the oil level whenever the appliance is to be into operation. Add engine oil if necessary.

PT Verifique o nível do óleo sempre que o aparelho estiver em funcionamento. Adicione óleo do motor, se necessário. Verifique o nível do óleo sempre que for colocar o aparelho em funcionamento. Adicione óleo do motor, se necessário.

FR Avant la première mise en marche, il est nécessaire de remplir le moteur d'huile de moteur. Contrôlez avant chaque mise en marche le niveau d'huile. Si nécessaire, complétez l'huile de moteur.

NL Vóór de eerste ingebruikname dient de motor beslist met motorolie gevuld worden. Controleer voor iedere inbedrijfstelling de oliestand. Vul eventueel de motorolie bij.

DE Vor Erstinbetriebnahme muss der Motor unbedingt mit Motorenöl befüllt werden. Überprüfen Sie vor jeder Inbetriebnahme den Ölstand.

IT E'indispensabile previa la prima messa in funzione riempire il motore con l'olio per motore. Prima di ogni messa in funzione controllare livello d'olio. Aggiungere eventualmente l'olio per motore.

ES Compruebe el nivel de aceite siempre que el aparato esté en funcionamiento. Agregue aceite de motor si es necesario. Compruebe el nivel de aceite siempre que vaya a poner en funcionamiento el aparato. Agregue aceite de motor si es necesario.



EN To ensure quality, every piece of equipment is subject to a test operation and filled with motor oil. Oil is drained before transport; however, there can be some motor oil remains on the dip stick. Please check carefully the oil level and add motor oil again.

PT Para garantir a qualidade, cada peça do equipamento é submetida a uma operação de teste e abastecida com óleo de motor. O óleo é drenado antes do transporte; no entanto, pode haver algum óleo do motor restante na vareta. Verifique cuidadosamente o nível de óleo e adicione óleo do motor novamente.

FR Afin d'assurer la qualité, chaque dispositif est soumis à une marche d'essai et rempli d'huile moteur. L'huile est vidée avant le transport, néanmoins, la jauge peut contenir des traces d'huile de moteur. Veuillez contrôler soigneusement le niveau d'huile et complétez l'huile moteur.

NL Om redenen van een kwaliteitscontrole wordt ieder apparaat ann test onderworpen en met motorolie gevuld. Voor het transport wordt de olie weer verwijderd, maar er kunnen toch nog resten van motorolie ann de peilstok achterlijven. Oliestand in elk geval nauwgezet controleren en zo nodig motorolie aanvullen.

DE Aus Gründen der Qualitätssicherung wird jedes Gerät einem Probelauf unterzogen und mit Motorenöl befüllt. Vor dem Transport wird das Öl wieder abgelassen, es können sich jedoch Rückstände von Motorenöl amb Messstab befinden. Bitte trotzdem Ölstand gewissenhaft überprüfen und Motorenöl nachfüllen.

IT Al fine di garantire la qualità, ogni apparecchio è sottoposto a prove funzionali di esercizio ed è riempito con carburante. Prima del trasporto, l'olio è svuotato, comunque sull'astina di controllo possono rimanere dei residui di olio motore. Perciò controllare con cura il livello dell'olio motore e rabboccarlo di nuovo.

ES Para garantizar la calidad, cada equipo se somete a una prueba de funcionamiento y se llena con aceite de motor. El aceite se drena antes del transporte; sin embargo, puede quedar algo de aceite de motor en la varilla. Compruebe cuidadosamente el nivel de aceite y vuelva a añadir aceite de motor.

EN Oil level inspection
FR Contrôle du niveau d'huile
DE Ölstand kontrollieren
IT Controllo livello d'olio
ES Inspección del nivel de aceite
PT Inspeção de nível de óleo
NL Oliepeil controleren

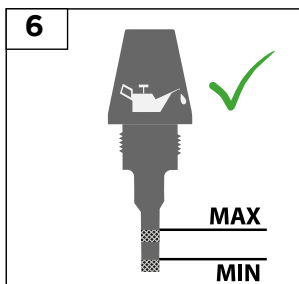
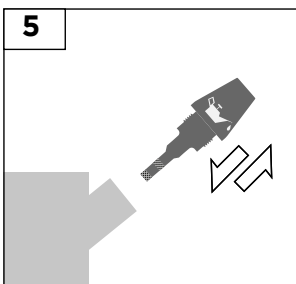
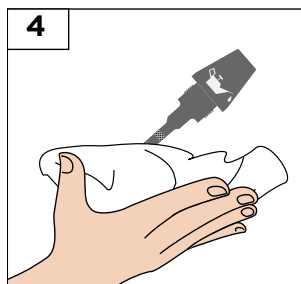
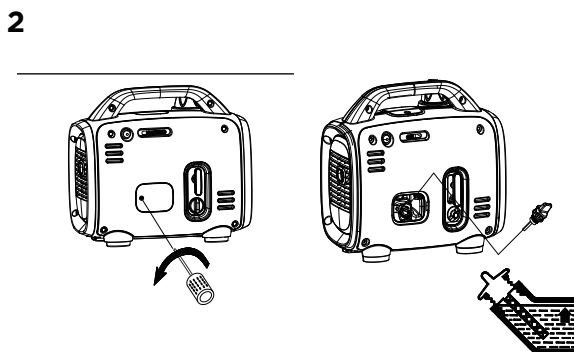
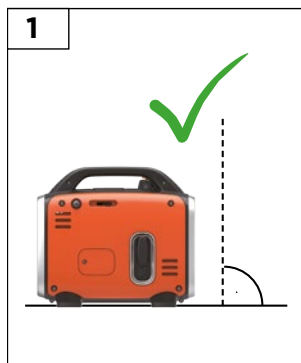

EN Oil level inspection
 FR Contrôle du niveau d'huile
 DE Ölstand kontrollieren
 IT Controllo livello d'olio
 ES Inspección del nivel de aceite
 PT Inspeção de nível de óleo
 NL Oliepeil controleren

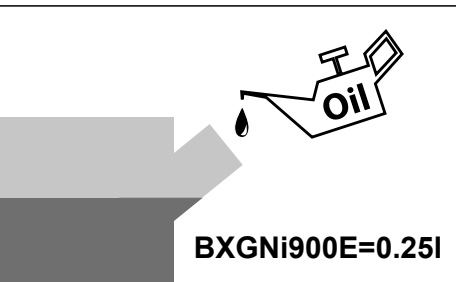
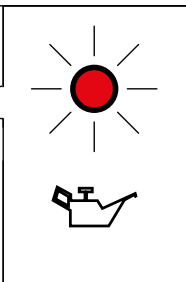
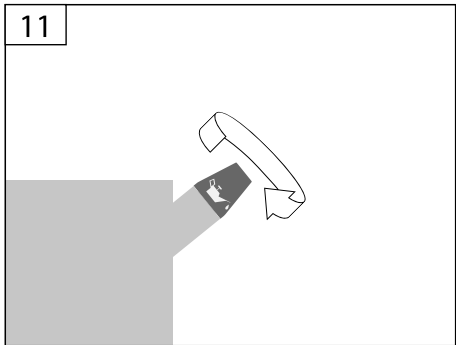
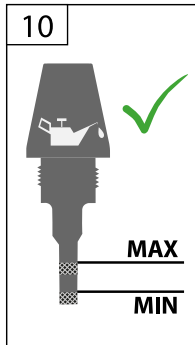
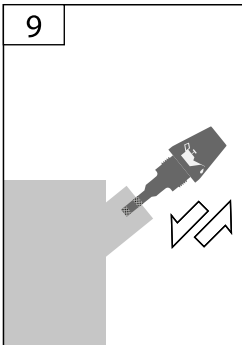
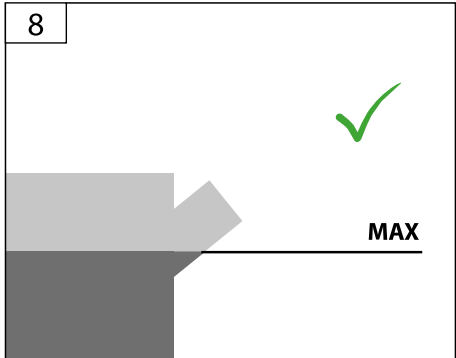
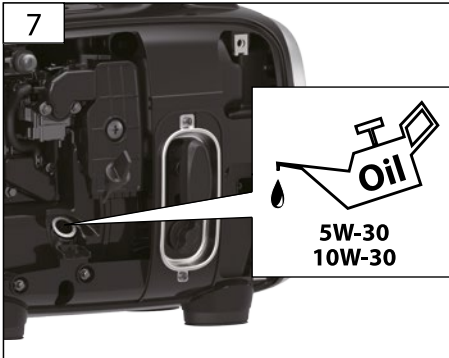

EN Fuel tank filling
 FR Ravitaillement
 DE Tanken
 IT Rabbocco
 ES Llenado del depósito de combustible
 PT Enchimento do tanque de combustível
 NL Tanken

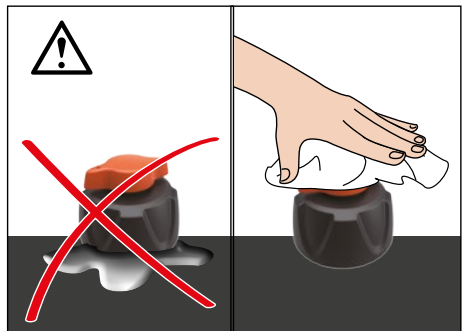
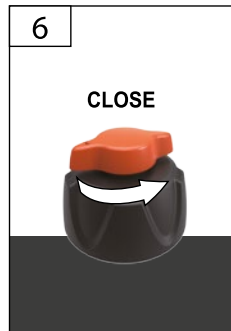
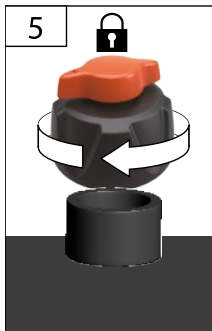
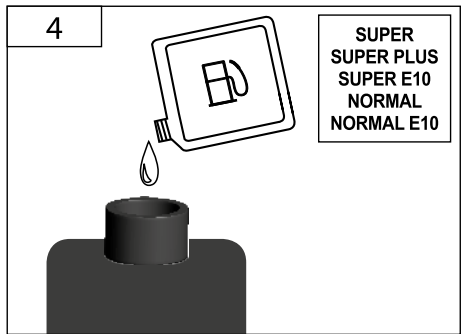
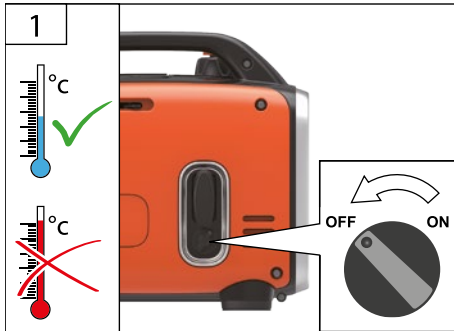

EN Operation - START
 FR Fonctionnement - START
 DE Betrieb - START
 IT Esercizio - START
 ES Operación - START
 PT Operação - START
 NL Gebruik - START

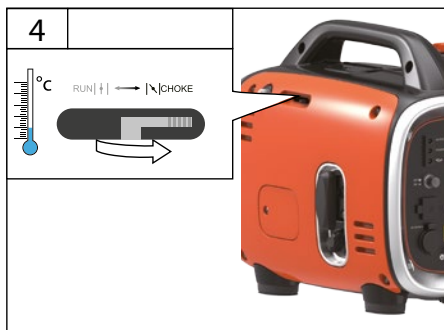
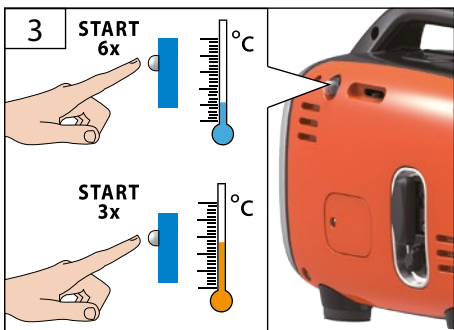
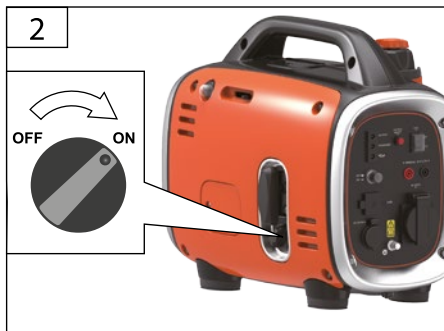
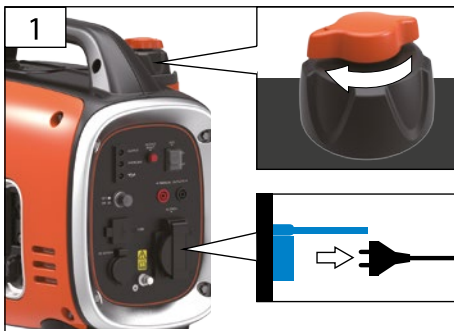

EN Operation - START
 FR Fonctionnement - START
 DE Betrieb - START
 IT Esercizio - START
 ES Operación - START
 PT Operação - START
 NL Gebruik - START

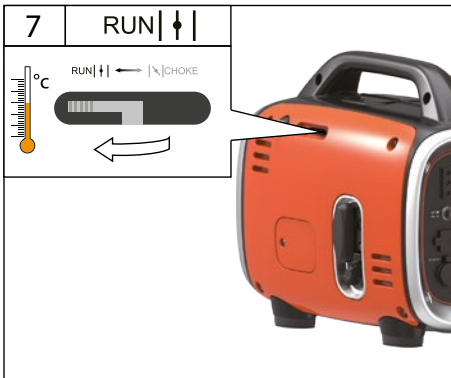
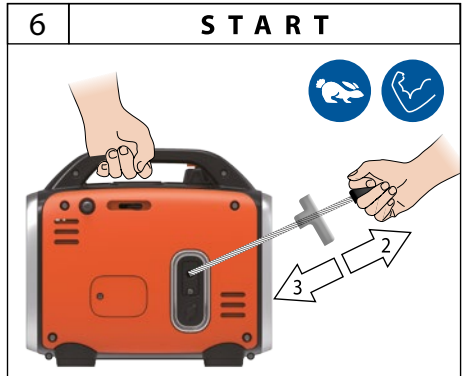
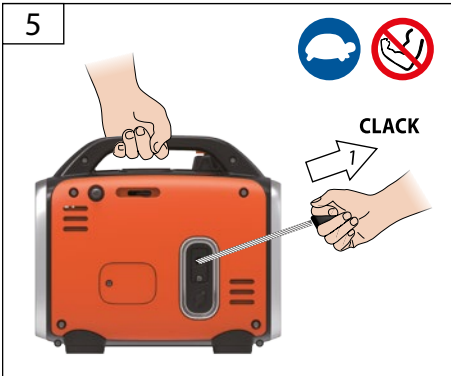
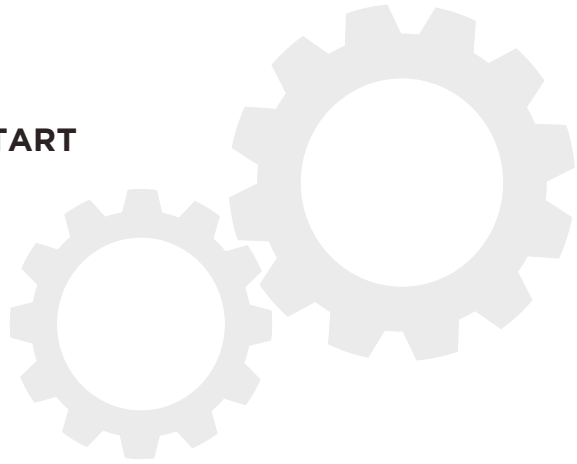

EN Operation
FR Fonctionnement
DE Betrieb
IT Esercizio
ES Operación
PT Operação
NL Gebruik

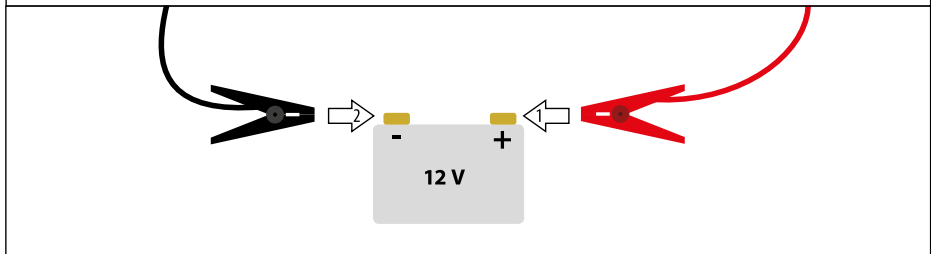
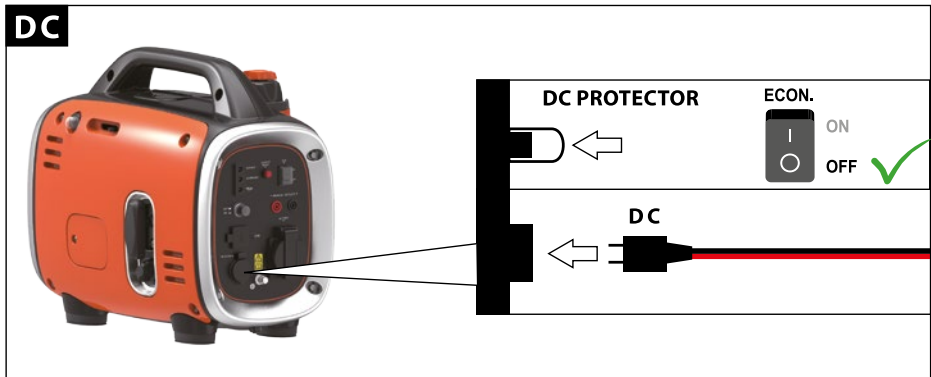
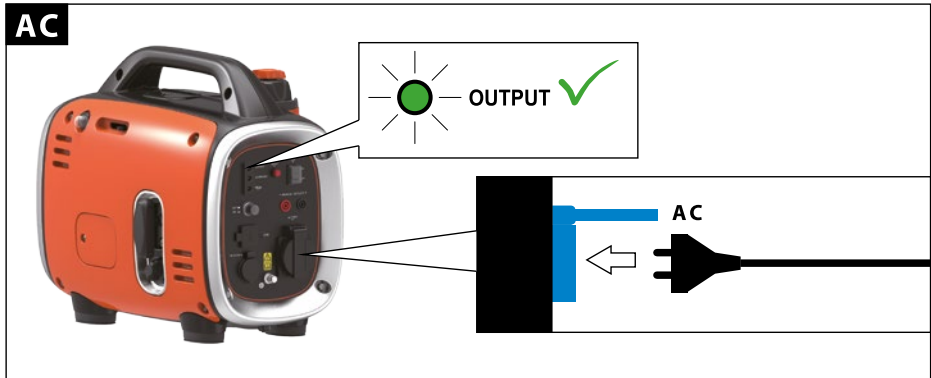
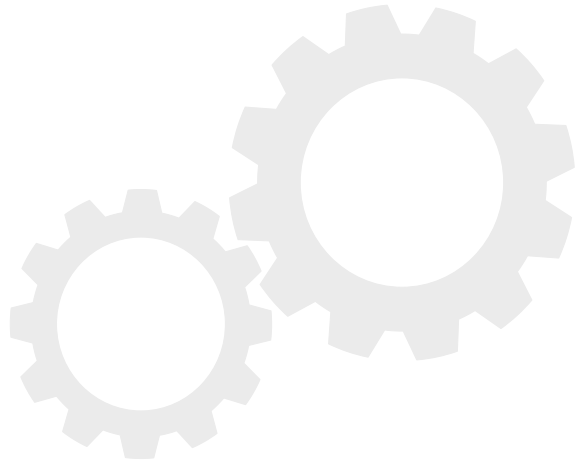

EN Operation - OVERLOAD
 FR Fonctionnement - Protection contre la surcharge
 DE Betrieb - ÜBERLASTSCHUTZ
 IT Esercizio - Protezione contro i sovraccarichi
 ES Operación - SOBRECARGA
 PT Operação - SOBRECARGA
 NL Gebruik - OVERBELASTINGSBEVEILIGING

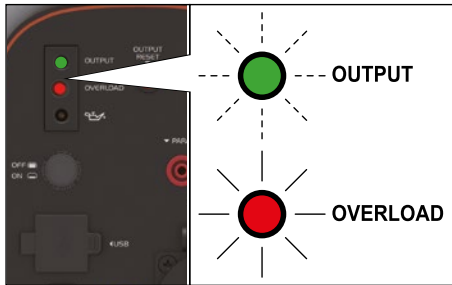

1	S T O P

2	C H E C K	

3	S T A R T

EN Operation - STOP
FR Fonctionnement - STOP
DE Betrieb - STOP
IT Esercizio - STOP
ES Operación - STOP
PT Operação - STOP
NL Werking - STOP

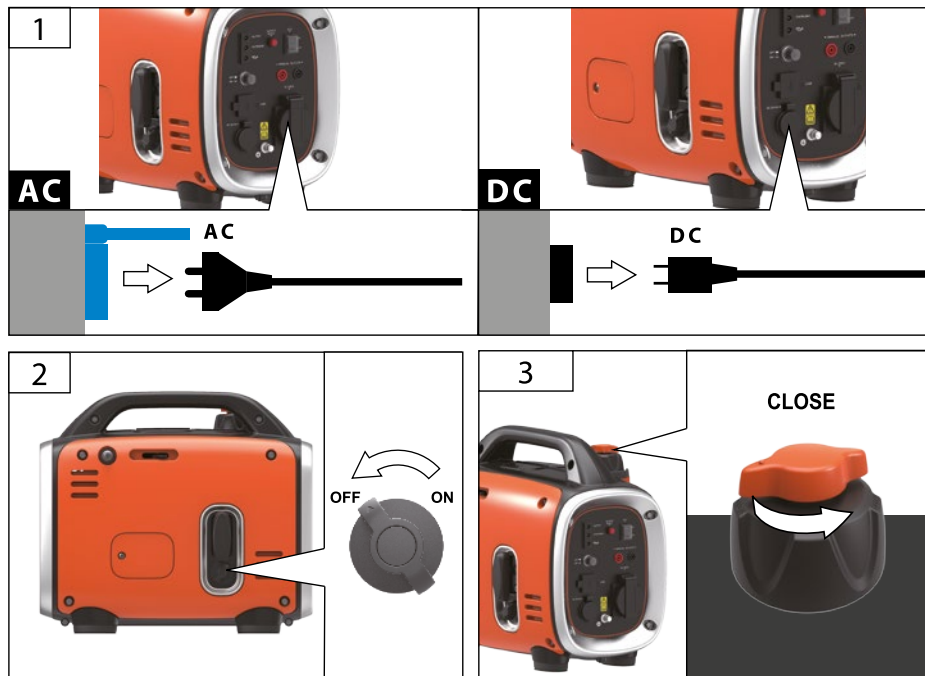
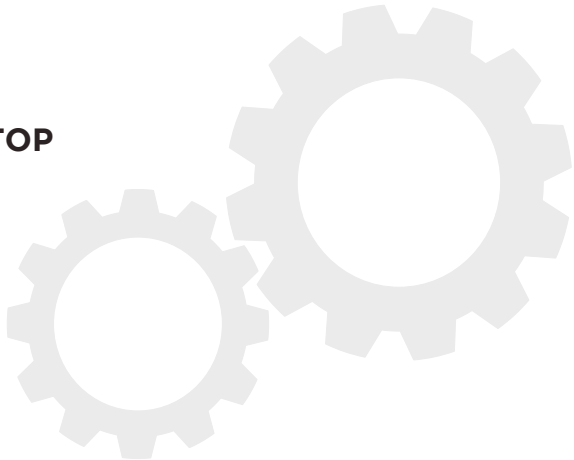

EN Spark plug change
 FR Changement de bougie
 DE Zündkerzenwechsel
 IT Sostituzione delle candele
 ES Cambio de bujía
 PT Troca de vela
 NL Bougie vervangen

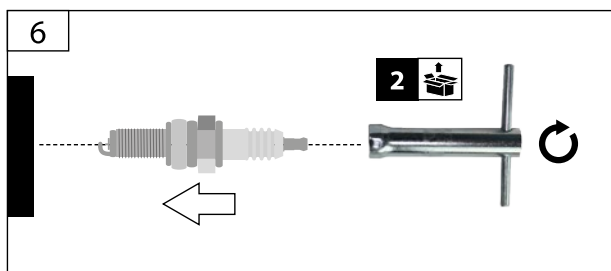
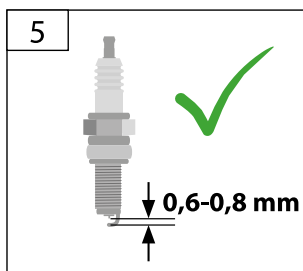
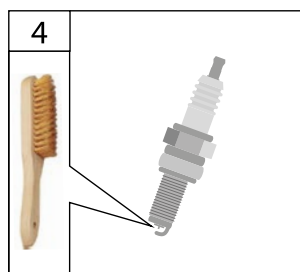
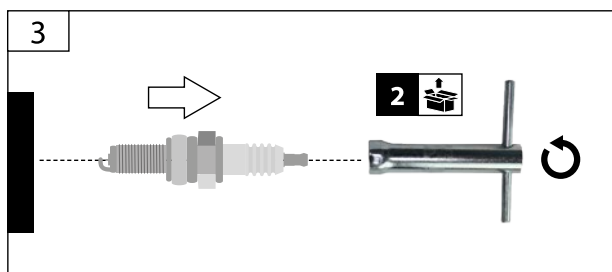
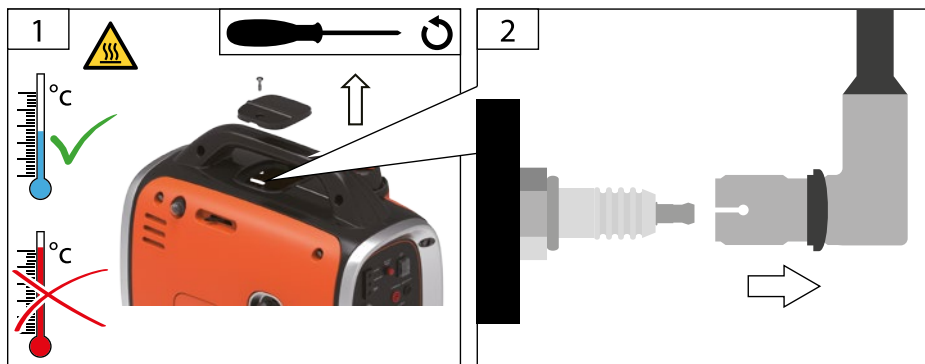

EN Oil change
 FR Remplacement d'huile
 DE Ölwechsel
 IT Cambio de l'olio
 ES Cambio de aceite
 PT Troca de óleo
 NL Olie vervanging



15W40
10W30

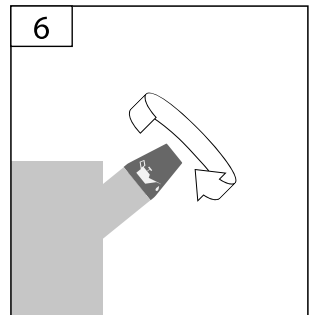
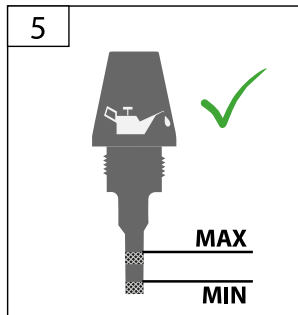
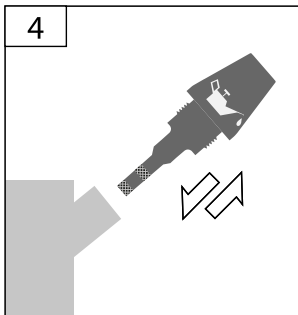
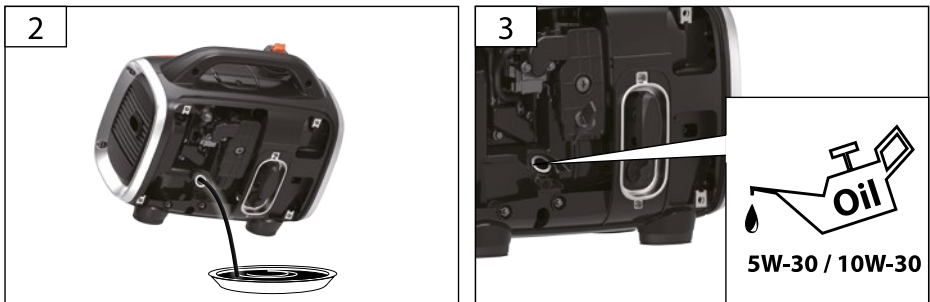
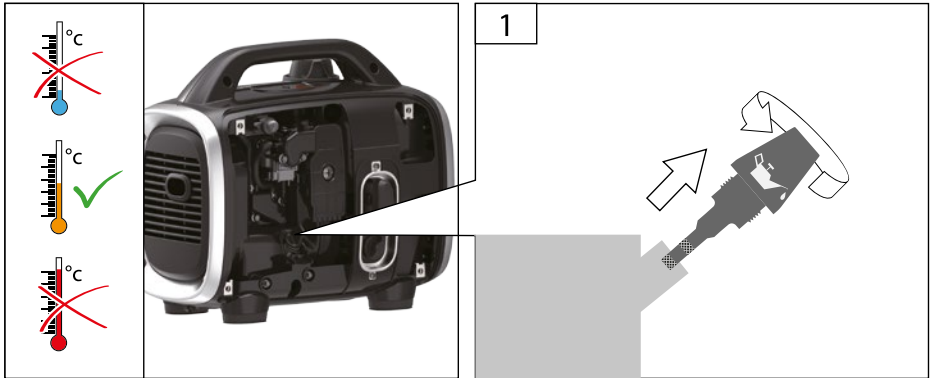

EN Air filter
FR Filtre à air
DE Luftfilter
IT Filtro d'aira
ES Filtro de aire
PT Filtro de ar
NL Luchtfilter

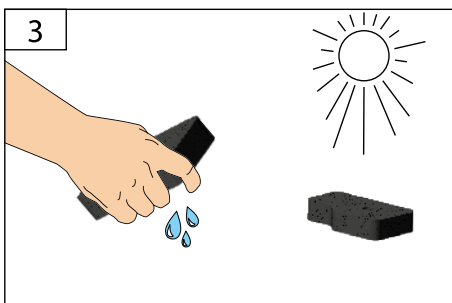
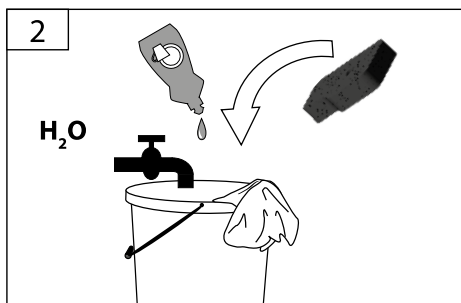
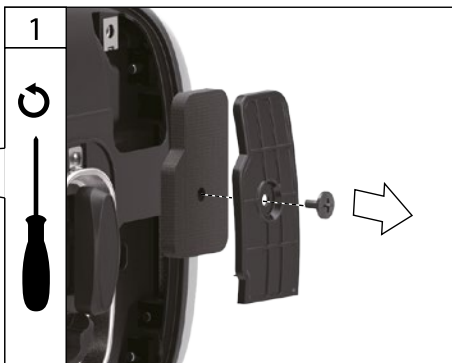
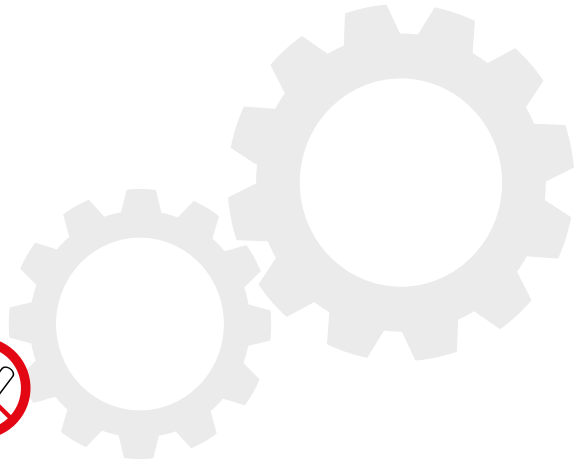

EN Fuel filter
FR Filtre à carburant
DE Kraftstofffilter
IT Filtro carburante
ES Filtro de combustible
PT Filtro de combustível
NL Brandstofffilter

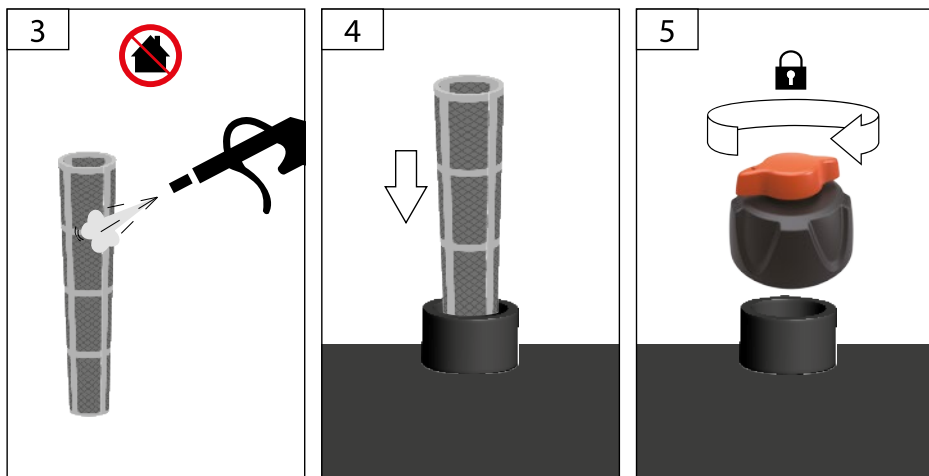
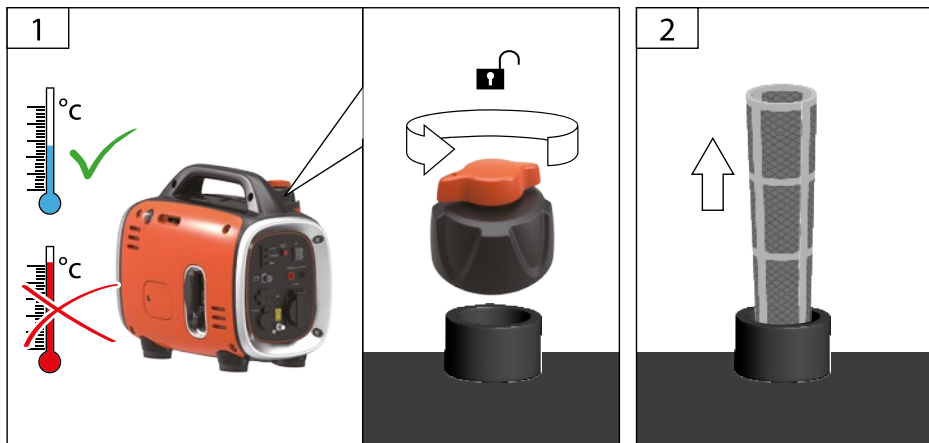
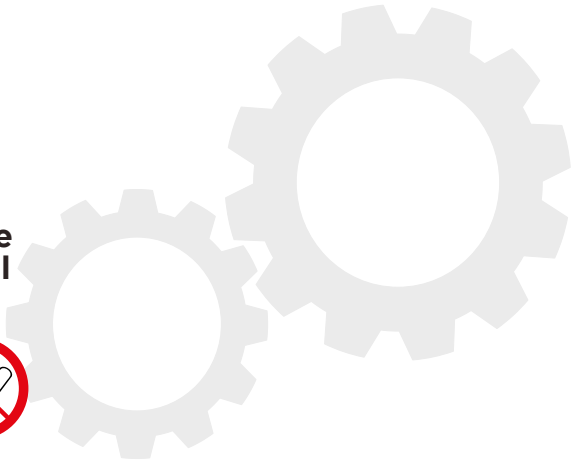

EN Transport / Storage
 FR Transport / Stockage
 DE Transport / Lagerung
 IT Transporto / Stoccaggio
 ES Transporte / Almacenaje
 PT Transporte / Armazenamento
 NL Transport / Bewaring

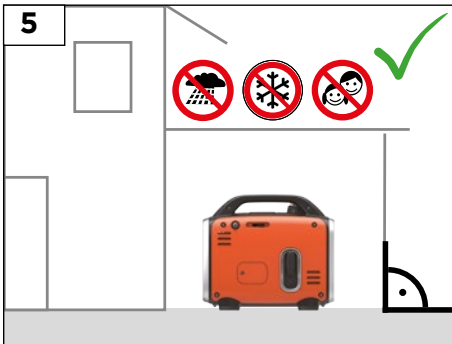
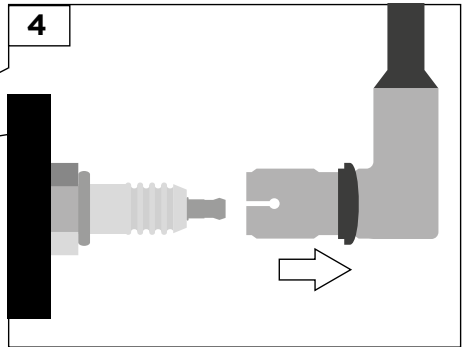
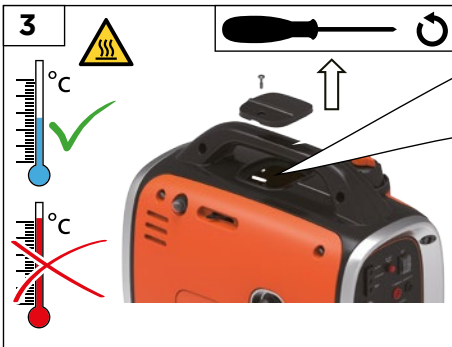
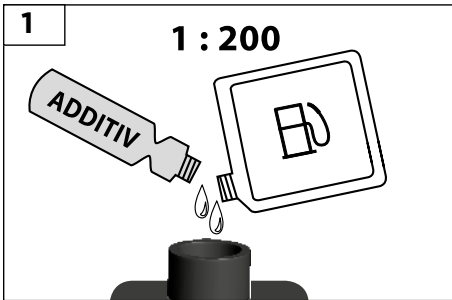
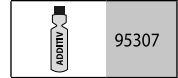

**TECHNICAL DATA / DONNÉES TECHNIQUES
 TECHNISCHE DATEN / DATI TECNICI /
 DATOS TÉCNICOS / DADOS TÉCNICOS
 TECHNISCHE DATA**

Generator	BXGNI900E
Rated Power	750W
Max Power	900W
Frecuency	50Hz
Voltage	230V
Fuel Tank capacity	2,1L
Engine	Petrol
Model	IC40I
Displacement	40cc
Starting System	Recoil Start
Cont. Op. Hours 100%	4,5h
Logistic	
Dimentiones	425x245x370 mm
Weight	9 kg

CE Declaración de Conformidad
EC Certificate of conformity
CE-Konformitätserklärung
CE Déclaration de conformité
CE Declaração de conformidade
CE Certificaat van Conformiteit
CE Certificato di conformità

ES
GB
DE
F
PT
NL
IT



Fabricante • Manufacturer • Hersteller • Fabricant • Fabricante • fabrikant • Produttore

KAT POWER INTERNATIONAL, S.L.

Por la presente certifica que lo siguiente • Hereby certifies that the following • Bescheinigt hiermit das die nachfolgenden •
Certifie ici que • Certifica que as seguintes • Verklaart hierbij dat het navolgende • Con la presente certifica che il seguente

Generadore • Generator • Stromerzeuger • Groupe Électrogène • Gerador • Stroomgenerator • Generatore

BXGNI900E

Cumple con las especificaciones de la directiva de la máquina y las modificaciones posteriores • Is in compliance with the
specifications of the machine directive and subsequent modifications • Steht im Einklang mit den folgenden Richtlinien •
Est fabriqué en conformité avec les directives suivantes • Está em conformidade com as especificações da diretiva de
máquina e modificações subsequentes • in overeenstemming is met de specificaties van de machinerichtlijn in latere
aanpassingen • È conforme alle specifiche della direttiva sulle macchine e successive modifichè

2006/42/EC (MD) Directiva Seguridad de las Máquina / Machine Directive
2014/30/EU (EMC) Directiva Compatibilidad Electromagnética / EMC Directive
2015/863 (amended 2011/65/EU) RoHS Directive
2000/14/EC (amended 2005/88/EC) Directiva Emisiones Sonoras / Sound Level Directive

87 Lwa dBA

2016/1628 Directiva Certificación Emisiones Gases / Emission EURO 5 Directive

E13*2016/1628*2016/1628SHA1/P*0212*00

Cumple con los siguientes estándares • Conforms with the following standards • In Übereinstimmung mit den
folgende Standards • Conformément aux normes suivantes Em conformidade com os seguintes padrões • Voldoet
aan de volgende normen • Conforme ai seguenti standard

EN ISO 8528-13:2016
EN ISO 60204-1:2006/AC:2010
EN ISO 5395-2: 2013
EN 55012:2007+A1:2009 and EN 61000-6-1:2007 (EMC)
EAN ISO 3744:2010, ISO8528-10:1998 (sound level)

KAT POWER INTERNATIONAL, S.L.

Avda. Alguema, 6C
17771 Sta. Llogaia Alguema, Spain

november 2020

Xavier Soteras
Managing Director



Black & Decker® and BLACK+DECKER™ and the Black & Decker® and BLACK+DECKER™ logos are registered trademarks of The Black & Decker® Corporation and are used under licence.
All rights reserved.

Manufactured and distributed by
KAT Power International S.L
Av. Àlguema 6C
17771 Santa Llogaia d'Àlguema
Girona - SPAIN