

BPK535060B

BPK535060M

CA	Manual d'usuari Forn	2
NL	Gebruiksaanwijzing Oven	27
EN	User Manual Oven	53
FR	Notice d'utilisation Four	78
DE	Benutzerinformation Backofen	105
IT	Istruzioni per l'uso Forno	132
PT	Manual de instruções Forno	158
ES	Manual de instrucciones Horno	184



Benvinguts a AEG! Gràcies per triar el nostre electrodomèstic.



Accedeix a consells d'ús, catàlegs, instruccions de resolució de problemes o informació sobre servei i reparacions a aeg.com/support



Per obtenir més receptes, consells o resolució de problemes, descarrega't l'aplicació **My AEG Kitchen**.



Subjecte a canvis sense preavis.

CONTINGUT

1. INFORMACIÓ DE SEGURETAT.....	2
2. INSTRUCCIONS DE SEGURETAT.....	4
3. DESCRIPCIÓ DEL PRODUCTE.....	7
4. Tauler de control.....	8
5. ABANS DEL PRIMER ÚS.....	9
6. ÚS DIARI.....	10
7. FUNCIONS DE RELLOTGE.....	14
8. ÚS DELS ACCESSORIS.....	16
9. FUNCIONS ADDICIONALS.....	17
10. CONSELLS.....	17
11. CURA I NETEJA.....	20
12. RESOLUCIÓ DE PROBLEMES.....	23
13. EFICIÈNCIA ENERGÈTICA.....	24
14. ESTRUCTURA DE MENÚ.....	26
15. QÜESTIONS MEDIAMBIENTALS.....	26

1. ⚠️ INFORMACIÓ DE SEGURETAT

Abans d'instal·lar i utilitzar l'aparell, llegiu detingudament les instruccions subministrades. El fabricant no es fa responsable de cap dany o lesió que sigui el resultat d'un ús o una instal·lació incorrectes. Manteniu sempre les instruccions en un lloc segur i accessible per a futures consultes.

1.1 Seguretat infantil i per a persones vulnerable

- Els nens majors de 8 anys i les persones amb capacitats físiques, sensorials o mentals reduïdes o manca d'experiència i coneixements poden fer servir aquest aparell només si estan supervisats o han rebut instruccions sobre l'ús segur de l'aparell i si comprenen els perills als

quals s'exposen. Els infants de menys de 8 anys i les persones amb discapacitats greus i complexes s'han de mantenir allunyats de l'aparell, tret que se'ls supervisi contínuament.

- Cal supervisar els infants per assegurar-vos que no juguin amb l'aparell .
- Manteniu tot l'embalatge lluny dels infants i llenceu-los correctament.
- AVÍS: L'aparell i les parts de contacte s'escalfen durant l'ús. Mantingui allunyats de l'aparell els infants i les mascotes quan estigui engegat i mentre s'estigui refredant.
- Si l'aparell disposa d'un sistema de bloqueig infantil, cal que l'activeu.
- Els infants no han de dur a terme operacions de neteja i manteniment de l'aparell sense supervisió.

1.2 Seguretat general

- Aquest electrodomèstic només té finalitats culinàries.
- Aquest aparell està dissenyat per a ús domèstic individual en interiors.
- Aquest aparell es pot utilitzar a oficines, habitacions d'hotels, habitacions d'hostals, cases rurals i altres allotjaments similars quan aquest ús no superi els nivells (mitjans) d'ús domèstic.
- La instal·lació d'aquest aparell i la substitució del cable només poden anar a càrrec d'una persona qualificada.
- No feu servir l'aparell abans d'instal·lar-lo a la seva estructura integrada.
- Abans de dur a terme qualsevol manteniment, desconnecteu l'aparell del subministrament elèctric.
- Si el cable d'alimentació està danyat, el fabricant, el centre de servei autoritzat o bé una persona qualificada l'haurà de substituir per evitar qualsevol perill elèctric.
- AVÍS: Comproveu que l'aparell estigui apagat abans de canviar el llum per evitar que es produeixin possibles descàrregues elèctriques.

- **AVÍS:** L'aparell i les parts de contacte s'escalfen durant l'ús. Tingueu cura i eviteu tocar els elements d'escalfament o la superfície de la cavitat de l'aparell.
- Utilitzeu sempre guants de forn per retirar o introduir accessoris o recipients al forn.
- Per retirar els suports de la reixeta, separeu de les parets laterals la part del davant del suport de la reixeta primer i, després, la part posterior. Instal·leu els suports de la reixeta en ordre invers.
- No feu servir netejadores de vapor per netejar l'aparell.
- No feu servir detergents abrasius agressius ni rascadors metàl·lics esmolats per netejar la porta de vidre, ja que podrien ratllar la superfície i fer que el vidre es trenqués.
- Abans de la neteja pirolítica, retireu tots els accessoris i els dipòsits/vessaments de la cavitat de l'aparell.

2. INSTRUCCIONS DE SEGURETAT

2.1 Instal·lació

AVÍS!

La instal·lació d'aquest aparell han d'anar a càrrec d'una persona qualificada.

- Retireu tot l'embalatge de l'aparell.
- No instal·leu ni utilitzeu aparells que estiguin avariats.
- Seguiu les instruccions d'instal·lació subministrades amb l'aparell.
- Vigileu quan moveu l'aparell, ja que pesa molt. Feu servir sempre guants de seguretat i calçat tapat.
- No intenteu moure l'aparell tirant del mànec.
- Instal·leu l'aparell en un lloc segur i adequat, d'acord amb els requisits d'instal·lació.
- Mantingueu la distància mínima en relació amb els altres aparells i unitats.
- Abans de muntar l'aparell, comproveu que la porta de l'aparell s'obre sense problemes.
- L'aparell està equipat amb un sistema de refredament elèctric. S'ha de fer servir amb subministrament elèctric.

- La unitat integrada ha de complir els requisits d'estabilitat de DIN 68930.

Alçada mínima de la cavitat (alçada mínima a sota la taula de treball)	578 (600) mm
Amplada de la cavitat	560 mm
Fondària de la cavitat	550 (550) mm
Alçada de la part frontal de l'aparell	594 mm
Alçada de la part posterior de l'aparell	576 mm
Amplada de la part frontal de l'aparell	595 mm
Amplada de la part del darrere de l'aparell	559 mm
Fondària de l'aparell	567 mm
Fondària d'encastatge de l'aparell	546 mm
Fondària amb la porta oberta	1027 mm

Espai mínim de ventilació	560x20 mm
Espai mínim de ventilació a la part posterior, a sota	
Llargada del cable d'alimentació. El cable és l'extrem dret del darrere de l'aparell	1500 mm
Cargols d'instal·lació	4x25 mm

2.2 Connexió elèctrica

AVÍS!

Risc d'incendi i descàrrega elèctrica.

- Totes les connexions elèctriques les ha de dur a terme un tècnic qualificat.
- L'aparell ha d'estar connectat a terra.
- Assegureu-vos que els paràmetres de la placa de característiques siguin compatibles amb les característiques elèctriques del subministrament elèctric.
- Feu servir sempre un sòcol antixoc correctament instal·lat.
- No feu servir adaptadors de múltiples endolls ni allargadors.
- Assegureu-vos no danyar el cable d'alimentació ni l'endoll. La substitució del cable d'alimentació l'ha de dur a terme el nostre centre de servei autoritzat.
- No deixeu que el cable d'alimentació toqui o entri en contacte amb la porta de l'aparell o la part inferior de la cavitat on heu instal·lat l'aparell, especialment quan està en funcionament o la porta és calenta.
- Totes les peces que assegurin la protecció contra descàrregues elèctriques de components aïllats i amb corrent s'han de fixar de manera que no es puguin afluixar sense eines.
- Només connecteu l'endoll a la presa de corrent al final del procés d'instal·lació. Asseguri's que es pugui accedir a l'endoll després de la instal·lació.
- Si el sòcol de la presa de corrent està solt, no connecti l'endoll.
- No estireu el cable d'alimentació per desconnectar l'aparell. Estireu sempre l'endoll.
- Empreneu només dispositius d'aïllament adequats: disjuntors de protecció, fusibles (de tipus cargol que es poden retirar del

suport), dispositius de fuga a terra i contactors.

- La instal·lació elèctrica ha d'incorporar un dispositiu d'aïllament que permeti desconnectar l'aparell de la presa de corrent en tots els pols. El dispositiu d'aïllament ha de tenir una separació mínima entre contactes de 3 mm.
- Tanqueu completament la porta de l'aparell abans d'endollar-lo a la presa de corrent.
- Aquest aparell se subministra amb un endoll principal i un cable principal.

2.3 Utilització

AVÍS!

Risc de lesió, cremades i descàrregues elèctriques o explosió.

- No modifiqueu les especificacions d'aquest aparell.
- Comproveu que els orificis de ventilació no estiguin bloquejats.
- No deixeu l'aparell desatès durant el funcionament.
- Desactiveu l'aparell després de cada ús.
- Teniu cura si obriu la porta de l'aparell quan estigui en funcionament. Podria sortir-ne aire calent.
- No feu servir l'aparell amb les mans molles ni quan l'aparell estigui en contacte amb l'aigua.
- No apliqueu pressió a la porta oberta.
- No feu servir l'aparell com a superfície de treball ni d'emmagatzematge.
- Obriu la porta de l'aparell amb cura. L'ús d'ingredients amb alcohol pot provocar una barreja d'alcohol i aire.
- No deixeu que les espurnes o flames entrin en contacte amb l'aparell quan obriu la porta.
- No col·loqueu productes inflamables ni articles humits amb productes inflamables dins, a prop o damunt de l'aparell.

AVÍS!

Risc d'espatllar l'aparell.

- Per evitar danys o decoloracions a l'esmalt:

- no poseu estris de forn ni altres objectes directament a la part inferior de l'aparell.
- no cobriu la base interior de l'aparell amb paper d'alumini.
- no introduïu aigua directament a l'aparell calent.
- no deixeu plats i aliments humits a l'aparell després d'acabar la cocció.
- aneu amb compte quan retireu o instal·leu els accessoris.
- El descoloriment de l'esmalt o l'acer inoxidable no té cap efecte sobre el rendiment de l'aparell.
- Feu servir una safata fonda per coure pastissos humits. Els sucus de fruites deixen taques que poden ser permanents.
- Cuineu sempre amb la porta del forn tancada.
- Si l'aparell està instal·lat al darrere del plafó d'algun moble (p. ex., una porta), assegureu-vos que la porta no quedi mai tancada mentre funciona l'aparell. Al darrere d'un plafó de moble que estigui tancat, s'hi poden acumular calor i humitat provocant danys a l'aparell, al mateix mobiliari o a terra. No tanqueu el plafó del moble fins que l'aparell s'hagi refredat després d'utilitzar-lo.

2.4 Cura i neteja

AVÍS!

Risc de lesions, incendi o d'espatllar l'aparell.

- Abans de fer cap tasca de manteniment, apagueu l'aparell i desconnecteu el cable de l'endoll.
- Assegureu-vos que l'aparell està fred. Hi ha risc que els plafons de vidre es puguin trencar.
- Substituïu immediatament els plafons de vidre de la porta si es fan malbé. Poseu-vos en contacte amb el Centre d'assistència autoritzat.
- Aneu amb compte en treure la porta de l'aparell. La porta pesa molt.
- Netegeu l'aparell regularment per evitar el deteriorament del material de la superfície.
- Netegeu l'aparell amb un drap humit. Feu servir només detergents neutres. No

utilitzeu productes abrasius, fregalls de neteja abrasius, dissolvents ni objectes metàl·lics.

- Si utilitzeu un esprai per a forns, seguïu les instruccions de seguretat de l'envàs.

2.5 Neteja pirolítica

AVÍS!

Risc de lesions/incendi/emissions químiques (fums) en mode pirolític.

- Abans de fer anar la neteja pirolítica i el preescalfament inicial, elimineu de la cavitat del forn:
 - qualsevol excés de residus de menjar i esquitxos/acumulacions d'oli o greix;
 - qualsevol objecte amovible (prestatges, baranes laterals, etc., que venen amb l'aparell), particularment estris antiadherents, olles, paelles, safates, recipients, etc.;
- Llegiu atentament totes les instruccions per a la neteja pirolítica.
- Mantingueu els infants allunyats de l'aparell mentre s'estigui duent a terme la neteja pirolítica. L'aparell s'escalfa molt i les reixetes de refrigeració frontals alliberen aire calent.
- La neteja pirolítica és un procés a alta temperatura que pot deixar anar fums dels residus del menjar i dels materials de fabricació, així que s'aconsella als consumidors que:
 - comptin amb una bona ventilació durant i després de cada neteja pirolítica;
 - comptin amb una bona ventilació durant i després del preescalfament inicial.
- No vesseu o aboqueu aigua a la porta del forn durant i després de la neteja pirolítica per evitar danyar els plafons de vidre.
- Els fums alliberats per qualsevol forn pirolític/residus de cocció segons es descriu anteriorment no són nocius per a les persones, inclosos els infants ni les persones amb afeccions de salut.
- Mantingueu allunyades les mascotes de l'aparell durant i després de la neteja pirolítica i el preescalfament inicial. Els animals petits (especialment els ocells i els rèptils) poden ser molt sensibles als

canvis de temperatura i a les emissions de fums.

- Les superfícies antiadherents dels diversos estris de cuina es poden fer malbé per l'alta temperatura de la neteja pirolítica de qualsevol forn pirolític i ser també una font de fums nocius de baixa intensitat.

2.6 Il·luminació interior

⚠ AVÍS!

Risc de descàrregues elèctriques.

- Quant a les bombetes incloses amb aquest producte i les que es venen per separat: estan dissenyades, o bé per aguantar condicions físiques extremes (temperatura, vibracions, humitat) en electrodomèstics, o bé per indicar l'estat de funcionament de l'aparell. No estan dissenyades per a qualsevol altre ús i no són indicades per a la il·luminació d'habitacions domèstiques.
- Aquest producte incorpora una font de llum d'eficiència energètica de classe G.

- Feu servir exclusivament bombetes amb les mateixes especificacions .

2.7 Manteniment i reparació

- Per reparar l'aparell, poseu-vos en contacte amb un centre tècnic autoritzat.
- Utilitzeu sempre recanvis originals.

2.8 Eliminació

⚠ AVÍS!

Risc de lesions o ofegament.

- Poseu-vos en contacte amb les vostres autoritats municipals per saber com eliminar l'aparell.
- Desconnecteu l'aparell de la xarxa elèctrica.
- Talleu el cable d'alimentació arran de l'aparell i tireu-lo.
- Retireu la fixació de seguretat de la porta per evitar que els infants o animals quedin atrapats en l'aparell.

3. DESCRIPCIÓ DEL PRODUCTE

3.1 Visió general

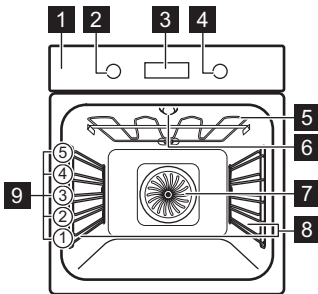

- 1 Tauler de control
- 2 Botó per a les funcions d'escalfament
- 3 Pantalla
- 4 Selector
- 5 Element d'escalfament
- 6 Llum
- 7 Ventilador
- 8 Suport de prestatge, desmuntable
- 9 Posicions del prestatge

3.2 Accessoris

Graella metàl·lica

Per a estris de cuina, motlles de pastissos, rostits.

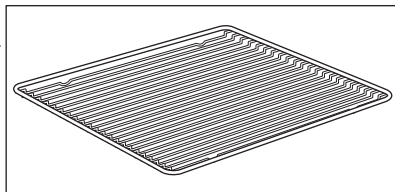

Safata de pastisseria

Per a pastissos i galetes.

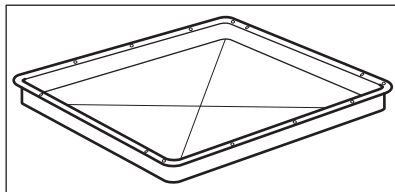

Grill/safata per a rostir

Per enfornar i rostir o com a paella per recollir greix.

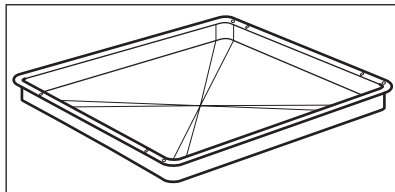

4. TAULER DE CONTROL

4.1 Botons retràctils

Per fer servir l'aparell, premeu el selector. El selector surt.

4.2 Visió general del tauler de control

Seleccioneu una funció d'escalfament per engegar l'aparell. Gireu el selector de les

funcions d'escalfament fins a la posició d'apagat (OFF) per apagar l'aparell.



Temporitzador



Escalfament ràpid



Llum



Bloqueig

OK

Confirmeu els ajustos

4.3 Pantalla

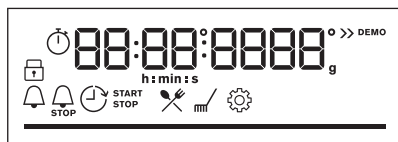

Mostrar amb les funcions de tecla.

Indicadors de pantalla

Indicadors bàsics



Indicadors del temporitzador



Barra de progrés: per a la temperatura o el temps. La barra és totalment vermella si l'aparell arriba a la temperatura programada.



5. ABANS DEL PRIMER ÚS

⚠ AVÍS!

Consulteu els capítols de seguretat.

5.1 Neteja inicial

Abans del primer ús, netegeu l'aparell en buit i ajusteu l'hora:



00:00

Establiu el temps. Premeu **OK**.

5.2 Preescalfament inicial

Preescalfeu el forn buit abans del primer ús.

Pas 1 Retireu tots els accessoris i les graelles de suport laterals extraïbles del forn.

Pas 2 Ajusteu la temperatura màxima de la funció: 
Deixeu el forn en marxa durant 1 h.

Pas 3 Ajusteu la temperatura màxima de la funció: 
Deixeu el forn en marxa durant 15 min.

 El forn pot emetre fum i despendre olor mentre s'escalfa. Assegureu-vos que la sala està ben ventilada.

6. ÚS DIARI

AVÍS!







Consulteu els capítols de seguretat.



6.1 Com ajustar: Funcions d'escalfament

Pas 1 Gireu el selector de les funcions d'escalfament i seleccioneu una funció.

Pas 2 Gireu el dial de control per ajustar la temperatura.

6.2 Funcions d'escalfament

Funció d'escalfament	Aplicació
 Aire calent	Per coure al forn en un màxim de tres nivells al mateix temps i deshidratar aliments. Reduïu la temperatura entre 20 i 40 °C menys que per a Cocció convencional.
 Cocció convencional	Per coure al forn i rostir aliments en un sol nivell.
 Aliments congelats	Per coure menjar preparat cruixent, p. ex., patates fregides, grills de patata i rotlles de primavera.
 Funció pizza	Per fer pizza. Per daurar bastant i per a bases cruixents.
 Calor inferior	Per fer pastissos amb base cruixent i conservar aliments.
 Descongela	Per descongelar aliments (fruita i verdures). El temps de descongelació depèn de la quantitat i la mida dels aliments congelats.
 Cocció amb ventilació	Aquesta funció està dissenyada per estalviar energia durant la cocció. Quan la feu servir, la temperatura dins l'aparell pot ser diferent de la que heu establert. Aprofita l'escalfor residual. Es pot reduir la potència. Per a més informació, vegeu el capítol "Ús diari", Notes a: Cocció amb ventilació.

Funció d'escalfament	Aplicació
 Grill	Per fer al grill trossos prims de menjar i per torrar pa.
 Graella turbo	Per rostir trossos grossos de carn o aviram amb ossos en un sol nivell. Per gratinar o daurar.
 Menú	Per entrar al menú: Cocció assistida, Neteja, Configuració.

6.3 Notes sobre: Cocció amb ventilació

Aquesta funció s'utilitzava per complir amb la classe d'eficiència energètica i els requisits de disseny ecològic (d'acord amb EU 65/2014 i EU 66/2014). Proves de conformitat amb: IEC/EN 60350-1.

La porta del forn ha de romandre tancada durant la cocció perquè la funció no s'interrompi i el forn funcioni amb el màxim nivell d'eficiència energètica possible.

Quan feu servir aquesta funció, el llum s'apaga automàticament després de 30 segons.

Per consultar les instruccions de cocció, vegeu el capítol «Consells i trucs», Cocció amb ventilació. Per obtenir recomanacions generals d'estalvi d'energia, consulteu el capítol «Eficiència energètica», Estalvi d'energia.







6.4 Com ajustar: Cocció assistida

Cada plat d'aquest submenú té una funció i temperatura d'escalfor recomanades. Feu servir la funció per preparar un plat més ràpidament amb els ajustos per defecte. Podeu canviar la temperatura en qualsevol moment durant la cocció.

Quan la funció acaba el seu temps, comproveu si el menjar està a punt.

Per a alguns plats també podeu cuinar amb:

- Pes automàtic

Pas 1	Pas 2	Pas 3	Pas 4
 	 	 P1 - P...	 OK
Entreu al menú.	Seleccioneu Cocció assistida. Premeu OK .	Trieu el plat. Premeu OK .	Poseu el plat dins el forn. Confirmeu els ajustos.















6.5 Cocció assistida

























Llegenda	
	Pes automàtic disponible.

















Llegenda	
	Preescalfeu l'aparell abans de començar la cocció.

Llegenda

 Nivell dels prestatges.



Plat	Pes	Nivell dels prestatges / Accessori
P1 Rosbif, poc fet		
P2 Rosbif, al punt	1 - 1.5 kg; 4 - 5 cm peces gruixudes	 2; safata de forn Fregiu la carn uns minuts amb una paella calenta. Poseu-ho a l'aparell.
P3 Rosbif, molt fet		
P4 Bistec, al punt	180 - 220 g per peça; 3 cm talls gruixuts	  3; estri de rostir al forn sobre la graella Fregiu la carn uns minuts amb una paella calenta. Poseu-ho a l'aparell.
P5 Bou/vedella rostits/estofats (costelles, tall rodó de dalt i falda gruixuda)	1.5 - 2 kg	  2; estri de rostir al forn sobre la graella Fregiu la carn uns minuts amb una paella calenta. Afegiu líquid. Poseu-ho a l'aparell.
P6 Rosbif, poc fet (cocció lenta)		
P7 Rosbif, al punt (cocció lenta)	1 - 1.5 kg; 4 - 5 cm peces gruixudes	 2; safata de forn poseu-hi les vostres espècies preferides o senzillament salpebreu amb pebre fresc. Fregiu la carn uns minuts amb una paella calenta. Poseu-ho a l'aparell.
P8 Rosbif, molt fet (cocció lenta)		
P9 Filet de bou, poc fet (cocció lenta)		
P10 Filet de bou, al punt (cocció lenta)	0,5 -,1,5 kg; 5 - 6 cm peces gruixudes	 2; safata de forn poseu-hi les vostres espècies preferides o senzillament salpebreu amb pebre fresc. Fregiu la carn uns minuts amb una paella calenta. Poseu-ho a l'aparell.
P11 Filet de bou, molt fet (cocció lenta)		
P12 Rostit de vedella (p. ex., espatlla)	0.8 - 1.5 kg; 4 cm peces gruixudes	  2; estri de rostir al forn sobre la graella Feu servir les vostres espècies preferides. Afegiu líquid. Rostit tapat.
P13 Rostit de porc (coll o espatlla)	1.5 - 2 kg	  2; estri de rostir al forn sobre la graella Gireu la carn a mig fer.
P14 Porc esqueixat (cocció lenta)	1.5 - 2 kg	 2; safata de forn Feu servir les vostres espècies preferides. Gireu la carn a mig fer per aconseguir un daurat uniforme.
P15 Cap de llom, fresc	1 - 1.5 kg; 5 - 6 cm peces gruixudes	 2; estri de rostir al forn sobre la graella Feu servir les vostres espècies preferides.
P16 Costelles de porc	2 - 3 kg; feu servir 2 - 3 cm costelles de porc crues i primes	 3; estri profund Afegiu líquid fins a cobrir el fons del plat. Gireu la carn a mig fer.

	Plat	Pes	Nivell dels prestatges / Accessori
P17	Cuixa de xai amb os	1.5 - 2 kg; 7 - 9 cm peces gruixudes	 2; estri de rostir sobre la safata de forn Afegiu líquid. Gireu la carn a mig fer.
P18	Pollastre sencer	1 - 1.5 kg; fresc	  2; cassola sobre la safata de forn Feu servir les vostres espècies preferides. Gireu el pollastre a mig fer per aconseguir un daurat uniforme.
P19	Mig pollastre	0.5 - 0.8 kg	 3; safata de forn Feu servir les vostres espècies preferides.
P20	Pit de pollastre	180 - 200 g per peça	  2; cassola sobre la graella Feu servir les vostres espècies preferides. Fregiu la carn uns minuts amb una paella calenta.
P21	Cuixes de pollastre, fresques	-	 3; safata de forn Si abans heu marinat les cuixes de pollastre, baixeu la temperatura i coeu-les més estona.
P22	Ànec enter	2 - 3 kg	  2; estri de rostir al forn sobre la graella Feu servir les vostres espècies preferides. Poseu la carn dins un estri de rostir. Gireu l'ànec a mig fer.
P23	Oca entera	4 - 5 kg	  2; estri profund Feu servir les vostres espècies preferides. Poseu la carn dins una safata de forn amb fondària. Gireu l'oca a mig fer.
P24	Pastís de carn	1 kg	 2; graella Feu servir les vostres espècies preferides.
P25	Peix sencer, a la graella	0.5 - 1 kg per peix	 2; safata de forn Farcieu el peix amb mantega i poseu-hi les vostres espècies i herbes preferides.
P26	Filet de peix	-	  3; cassola sobre la graella Feu servir les vostres espècies preferides.
P27	Pastís de formatge	-	 2;  28 cm motlle desmuntable sobre la graella
P28	Pastís de poma	-	 3; safata de forn
P29	Pastís de poma	-	 2; motlle de pastís sobre la graella
P30	Apple pie	-	 1;  22 cm motlle de pastís sobre la graella
P31	Brownies	2 kg de massa	 3; estri profund
P32	Muffin de xocolata	-	 3; safata de muffins sobre la graella
P33	Pa de pessic	-	 2; motlle de pa sobre la graella

	Plat	Pes	Nivell dels prestatges / Accessori
P34	Patates al forn	1 kg	 2; safata de forn Poseu les patates senceres sobre la safata de forn.
P35	Patates americanes	1 kg	 3; safata de forn amb paper d'enfornar Feu servir les vostres espècies preferides. Talleu les patates a trossos.
P36	Verdures a la planxa	1 - 1.5 kg	 3; safata de forn amb paper d'enfornar Feu servir les vostres espècies preferides. Talleu les verdures a trossos.
P37	Croquetes, congelades	0.5 kg	 3; safata de forn
P38	Pomes, congelades	0.75 kg	 3; safata de forn
P39	Lasanya vegetal/de carn amb fulls de pasta seca	1 - 1.5 kg	 2; cassola sobre la graella
P40	Patates gratinades (patates crues)	1 - 1.5 kg	 1; cassola sobre la graella Gireu el plat a mig fer.
P41	Pizza fresca, prima	-	  2; safata de forn amb paper d'enfornar
P42	Pizza fresca, gruixuda	-	  2; safata de forn amb paper d'enfornar
P43	Quiche	-	 2; motlle de forn sobre la graella
P44	Baguet / Xapata / Pa blanc	0.8 kg	  2; safata de forn amb paper d'enfornar El pa blanc necessita més temps.
P45	Pa integral / Pa de sègol / Pa negre	1 kg	  2; safata de forn amb paper d'enfornar / motlle de pa sobre la graella

7. FUNCIONS DE RELLOTGE

7.1 Funcions del rellotge

Funció de rellotge	Aplicació
 Comptador de minuts	Quan el temporitzador arriba al temps establert, sona un senyal.
 Temps de cocció	Quan el temporitzador arriba al temps establert, sona un senyal i la funció d'escalfament s'atura.
 Temporitzador	Per ajornar l'inici i/o l'acabament de la cocció.

Funció de rellotge	Aplicació
 Temporitzador	El màxim és de 23 h 59 min. Aquesta funció no té cap efecte sobre el funcionament del forn. Per engegar i parar el Temporitzador, seleccioneu: Menú, Configuració.

7.2 Com ajustar: Funcions del rellotge

Com configurar: Hora del dia

Pas 1



Pas 2



Pas 3



Per canviar l'hora del dia, accediu al menú i seleccioneu Ajustos, Hora del dia.

Ajusteu el rellotge.

Premeu: **OK**.

Com configurar: Comptador de minuts

Pas 1



Premeu: .

A la pantalla apareix:
0:00

Pas 2



Ajusteu el Comptador de minuts

Pas 3



Premeu: **OK**.

 El temporitzador comença el compte enrere immediatament.

Com configurar: Temps de cocció

Pas 1



Seleccioneu una funció d'escalfament i ajusteu la temperatura.

Pas 2



Premeu repetidament: .

A la pantalla apareix:
0:00

STOP

Pas 3



Seleccioneu el temps de cocció.

Pas 4



Premeu: **OK**.

 El temporitzador comença el compte enrere immediatament.

Com configurar: Temporitzador

Pas 1	Pas 2	Pas 3	Pas 4	Pas 5	Pas 6
					
Seleccio- neu la fun- ció d'escal- fament .	Premeu repe- tidament: 	La pantalla mostra: l'hora del dia  START	Ajusteu l'ho- ra d'inici.	A la panta- lla apareix: --:--  STOP	Ajusteu l'hora d'aca- bament.
			Premeu: OK		Premeu: OK

 El temporitzador comença el compte enrere a partir de l'hora d'inici establerta.

8. ÚS DELS ACCESSORIS

AVÍS!

Consulteu els capítols de seguretat.

8.1 Inserció d'accessoris

Una petita ranura situada a la part superior augmenta la seguretat. Aquestes ranures

també eviten que es puguin bolcar. La vora exterior realçada de la graella és un dispositiu especial per evitar el lliscament dels utensilis de la lleixa.

Graella metàl·lica:

Introduïu el prestatge entre les guies de les graelles de suport laterals .

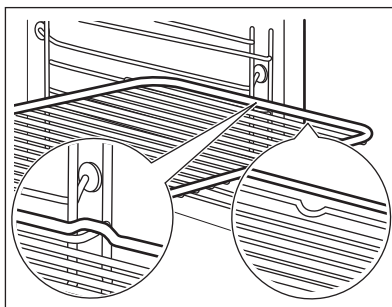

Safata de pastisseria / Safata fonda:

Empenyeu la safata entre les barres de guia del suport lateral.

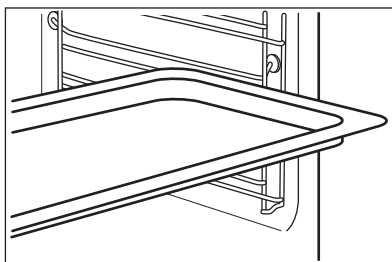

9. FUNCIONS ADDICIONALS

9.1 Bloqueig

Aquesta funció evita canvis accidentals del mode de funcionament de l'aparell.

Activeu-lo quan l'aparell està funcionant: la cocció establerta continua i el tauler de control està bloquejat.
Activeu-lo quan l'aparell està apagat: no es pot activar perquè el tauler de control està bloquejat.





: mantingueu-lo premut per activar la funció.
Sona un senyal acústic.

: mantingueu-lo premut per apagar-lo.

 3 x : parpelleja quan el bloqueig està activat.

9.2 Desconnexió automàtica

Per motius de seguretat, si la funció d'escalfament és activa i no s'han canviat els ajustos, l'aparell s'apagarà automàticament després d'una estona.

 (°C)	 (h)
30 - 115	12.5
120 - 195	8.5
200 - 245	5.5

 (°C)

 (h)

250: màxim

3

La funció d'apagada automàtica no s'activa amb les funcions: Llum, Temporitzador.

9.3 Ventilador de refrigeració

Quan l'aparell està en funcionament, el ventilador de refrigeració s'activa automàticament per tal de mantenir les superfícies de l'aparell fredes. Si desactiveu el forn, el ventilador de refrigeració seguirà funcionant fins que l'aparell es refredi.

10. CONSELLS

10.1 Recomanacions de cocció





La temperatura i els temps de cocció de les taules són de referència. Depenen de les receptes i de la qualitat i la quantitat dels ingredients utilitzats.

El seu aparell pot coure o rostir de manera diferent a l'aparell que teníeu abans. Els consells següents mostren la configuració recomanada de temperatura, temps de cocció i nivell per a tipus específics d'aliments.

Si no podeu trobar la configuració d'una recepta especial, cerqueu la que sigui similar.



10.2 Cocció amb ventilació

Per aconseguir els millors resultats, seguiu les indicacions de la taula següent.

	°C		
Pasta gratinada	200 - 220	45 - 55	3
Patates gratinades	180 - 200	70 - 85	3
Mussaca	170 - 190	70 - 95	3
Lasanya	180 - 200	75 - 90	3
Canelons	180 - 200	70 - 85	3
Púding	190 - 200	55 - 70	3
Púding d'arròs	170 - 190	45 - 60	3
Pastís de poma, esponjós (motlle rodó)	160 - 170	70 - 80	3
Pa blanc	190 - 200	55 - 70	3

10.3 Coccí amb ventilació: accessoris recomanats

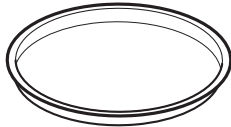
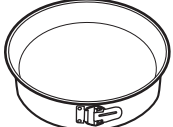
Feu servir recipients i motlles foscos, no reflector. Absorbeixen millor l'escalfor que els materials de colors foscos i reflectors.





			
Paella per a pizza	Plat de coccí	Ramequin	Motlle de flam
Fosc, no reflector 28 cm de diàmetre	Fosc, no reflector 26 cm de diàmetre	Ceràmica 8 cm de diàmetre, 5 cm d'alçada	Fosc, no reflector 28 cm de diàmetre





10.4 Taules de coccí pels instituts d'assaigs

Informació pels organismes de proves i assaigs





Proves de conformitat amb: EN 60350, IEC 60350.

Coccí a un nivell: coccí amb motlles





				
		°C	min	
Fatless sponge cake	Aire calent	160	45 - 60	2
Fatless sponge cake	Coccí convencional	160	45 - 60	2
Pastís de poma, 2 motlles de 20 cm de diàmetre	Aire calent	160	55 - 65	2

		 °C	 min	
Pastís de poma, 2 motlles de 20 cm de diàmetre	Cocció convencional	180	55 - 65	1
Short bread (galletes escoceses)	Aire calent	140	25 - 35	2
Short bread (galletes escoceses)	Cocció convencional	140	25 - 35	2

Cocció a un nivell: galletes
Feu servir el tercer nivell.





		 °C	 min
Pastissos petits, 20 per safata, precalentar el forn buit	Aire calent	150	20 - 30
Pastissos petits, 20 per safata, precalentar el forn buit	Cocció convencional	170	20 - 30

Cocció a diversos nivells: galletes

		 °C	 min	
Short bread (galletes escoceses)	Aire calent	140	25 - 45	2 / 4
Pastissos petits, 20 per safata, precalentar el forn buit	Aire calent	150	25 - 35	1 / 4
Fatless sponge cake	Aire calent	160	45 - 55	2 / 4
Pastís de poma, 1 safata per reixeta (Ø 20 cm)	Aire calent	160	55 - 65	2 / 4

Grill
Preescalfeu el forn buit durant 5 minuts.

Rostiu amb l'ajust de temperatura màxima.

		 min	
Torrades	Grill	1 - 2	5
Filet de carn de bou, doneu-li la volta quan hagi transcorregut la meitat del temps	Grill	24 - 30	4

11. CURA I NETEJA

⚠ AVÍS!

Consulteu els capítols de seguretat.

11.1 Notes sobre la neteja



Productes de neteja

Netegeu la part davantera de l'aparell amb un drap de microfibra mullat amb aigua tèbia i un detergent suau.

Feu servir una solució de neteja per netejar superfícies de metall.

Netegeu les taques amb un detergent suau.



Ús diari

Netegeu la cavitat després de cada ús. L'acumulació de greix o altres residus pot provocar un incendi.

No emmagatzemeu menjar a l'aparell durant més de 20 minuts. Eixugueu la cavitat amb un drap de microfibra després de cada ús.



Accessoris

Netegeu tots els accessoris després de fer-los servir i deixeu-los eixugar. Feu servir només un drap de microfibra mullat amb aigua tèbia i detergent suau. No netegeu els accessoris al rentavaixel·la.

No netegeu els accessoris antiadherents amb un producte de neteja abrasiu o amb objectes afilats.

11.2 Com treure'l: Suports laterals

Per netejar el forn, retireu els suports laterals.

Pas 1 Apagueu el forn i espereu fins que es refredi.

Pas 2 Agafeu la part davantera del suport de la reixeta i tireu-lo cap a fora fins a treure'l de la paret lateral.

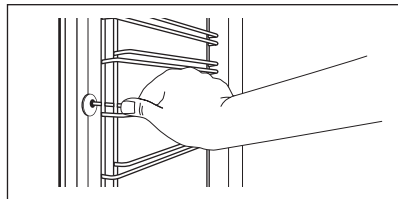

Pas 3 Agafeu la part posterior del suport de la reixeta i tireu-lo cap a fora fins a treure'l de la paret lateral i retireu-lo.

Pas 4 Instal·leu els suports de la graella en ordre invers.

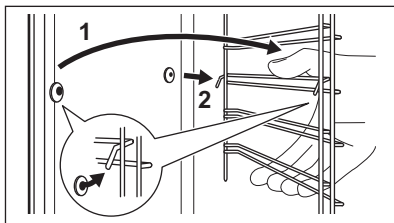

11.3 Com utilitzar: Neteja pirolítica

Netegeu el forn amb Neteja pirolítica.

⚠ AVÍS!

Hi ha risc de cremades.

⚠ PRECAUCIÓ!

Si hi ha altres aparells instal·lats en el mateix moble, no els feu servir mentre està en marxa aquesta funció. Pot fer malbé el forn.

Abans de la Neteja pirolítica:

Apagueu el forn i espereu fins que es refredi.

Retireu tots els accessoris i les graelles de suport laterals extraïbles.

Netegeu la base del forn i el vidre interior de la porta amb aigua tèbia, un drap i un detergent suaus.

Neteja pirolítica

Pas 1

Accediu al menú: Neteja mm / .

Opció

Durada

C1: Neteja suau

1 h

C2: Neteja normal

1 h 30 min

C3: Neteja a fons

3 h

Pas 2

OK: premeu per seleccionar el programa de neteja.

Pas 3

OK: premeu per iniciar la neteja.

Pas 4

Després de la neteja, gireu el selector de les funcions d'escalfament fins a la posició d'apagat (OFF).

ⓘ Quan s'inicia la neteja, la porta del forn es bloqueja i el llum s'apaga. Fins que la porta es desbloquegi, la pantalla mostra: .

Quan finalitzi la neteja:

Apagueu el forn i espereu fins que es refredi.

Netegeu la cavitat amb aigua calenta i un drap suau.

Netegeu el residu del fons de la cavitat.

11.4 Recordatori de neteja

El forn us recorda quan s'ha de netejar amb la neteja pirolítica.

Després de cada sessió de cocció, mm / parpelleja a la pantalla durant 5 segons.

Per desactivar el recordatori, accediu a Menú i seleccioneu Configuració, Recordatori de neteja.

11.5 Com extreure i instal·lar: Porta

Podeu treure la porta i el vidres interiors per netejar-los. El nombre de plafons de vidre és diferent per a cada model.

⚠ AVÍS!

La porta pesa molt.

⚠ PRECAUCIÓ!

Tracteu el vidre amb cura, especialment al voltant de les vores del plafó davanter. El vidre podria trencar-se.

Pas 1 Obriu la porta completament.

Pas 2 Aixequeu i premeu les palanques de fixació (A) a les dues frontisses de la porta.

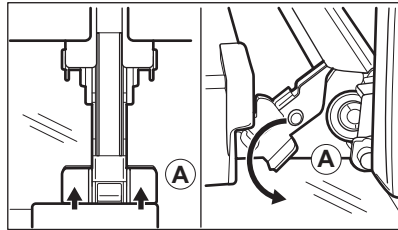

Pas 3 Tanqueu la porta del forn a la primera posició d'obertura (un angle d'aproximadament 70°). Aguanteu els dos costats de la porta i tireu d'ella en direcció oposada al forn i cap amunt. Col·loqueu la porta amb la part exterior cap avall sobre un drap suau i una superfície estable.

Pas 4 Agafeu l'embellidor (B) a la vora superior de la porta pels dos costats i empenyeu cap a dins per alliberar el segell del clip.

Pas 5 Tireu l'embellidor cap endavant per retirar-lo.

Pas 6 Agafeu els plafons de vidre de la porta per la vora superior un per un i tireu cap amunt fins a treure'ls de les guies.

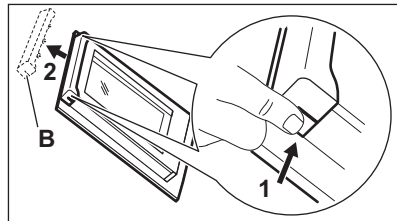

Pas 7 Netegeu el plafó de vidre amb aigua i sabó. Assequeu el plafó de vidre amb cura. No netegeu els plafons de vidre al rentavaixelles.

Pas 8 Després de la neteja, feu els passos anteriors en l'ordre oposat.

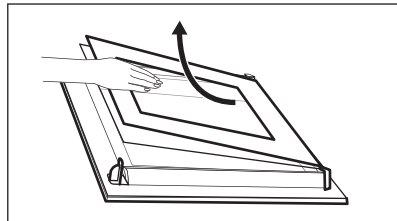

Pas 9 Instal·leu primer el plafó més petit, després el més gran i la porta.

11.6 Com substituir-lo: Llum

AVÍS!

Risc de descàrregues elèctriques.
La bombeta pot estar calenta.

Abans de substituir el llum:

Pas 1	Pas 2	Pas 3
Apagueu el forn. Espereu fins que el forn es refredi.	Desconnecteu el forn de la xarxa elèctrica.	Col·loqueu un drap a la part inferior de la cavitat.

Llum superior

Pas 1 Feu girar la coberta de vidre per retirar-la.

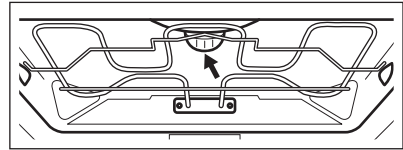

Pas 2 Netegeu la coberta de vidre.

Pas 3 Substituiu la bombeta per una d'adequada resistent a la calor a 300 °C.

Pas 4 Col·loqueu la coberta de vidre.

12. RESOLUCIÓ DE PROBLEMES

AVÍS!

Consulteu els capítols de seguretat.

12.1 Què fer si...

Si el vostre cas no s'inclou en aquesta taula, poseu-vos en contacte amb un centre de servei autoritzat.



L'aparell no s'encén o no s'escalfa

Problema	Comproveu que...
L'aparell no es pot engegar o no funciona.	L'aparell està connectat correctament al subministrament elèctric.
L'aparell no s'escalfa.	La desconexió automàtica està desactivada.
L'aparell no s'escalfa.	La porta de l'aparell està tancada.
L'aparell no s'escalfa.	El fusible no està fos.



L'aparell no s'encén o no s'escalfa

L'aparell no s'escalfa.

La funció de bloqueig està desactivada.



Components

Problema

Comproveu que...

El llum s'apaga.

Coccio amb ventilació: està activat.

El llum no funciona.

El llum s'ha fos.



Codis d'error

La pantalla mostra...

Comproveu que...

Err C3

La porta de l'aparell està tancada o el tancament de la porta està trencat.

Err F102

La porta de l'aparell està tancada.

Err F102

El bloqueig de la porta està trencat.

00:00

Hi ha hagut una interrupció del subministrament elèctric. Estableix l'hora del dia.

Si la pantalla mostra un codi d'error que no es troba a la taula, apagueu i enceneu els fusibles de la llar per reiniciar l'aparell. Si es torna a mostrar el codi d'error, poseu-vos en contacte amb un centre de servei tècnic autoritzat.

12.2 Dades per a la reparació

Si no podeu solucionar el problema, poseu-vos en contacte amb el vostre distribuïdor o amb un centre de servei autoritzat.

Les dades necessàries per al centre de servei s'indiquen a la placa d'identificació. La placa de dades tècniques està situada al marc davanter de la cavitat de l'aparell. No retireu la placa d'identificació de la cavitat de l'aparell.

Us recomanem que anoteu les dades aquí:

Model (MOD.)

Número de producte (PNC)

Número de sèrie (S.N.)

13. EFICIÈNCIA ENERGÈTICA

13.1 Informació del producte i full d'informació del producte segons la normativa de disseny ecològic i etiquetatge energètic de la UE

Nom del proveïdor

AEG

Identificació de model	BPK535060B 944188596 BPK535060M 944188597	
Índex d'eficiència energètica	81.2	
Classe d'eficiència energètica	A+	
Consum energètic amb càrrega normal i mode convencional	1.09 kWh/cicle	
Consum energètic amb càrrega normal i mode amb ventilació	0.69 kWh/cicle	
Nombre de cavitats	1	
Font de calor	Electricitat	
Volum	71 l	
Tipus de forn	Forn encastat	
Massa	BPK535060B	35.0 kg
	BPK535060M	35.0 kg

IEC/EN 60350-1: Aparells elèctrics de cocció d'ús domèstic - Part 1: Cuines, forns, forns de vapor i grills; mètodes de mesura de rendiment.

13.2 Estalvi d'energia



L'aparell inclou funcions que us poden ajudar a estalviar energia en la cocció diària.

Assegureu-vos que la porta de l'aparell estigui tancada quan l'aparell funcioni. No obriu sovint la porta de l'aparell durant la cocció. Manteniu la junta de la porta neta i assegureu-vos que està ben fixada al seu lloc.

Feu servir estris de cuina metàl·lics per estalviar energia.

Sempre que us sigui possible, no preescalfeu l'aparell abans de la cocció.

Deixeu passar el mínim de temps possible entre coccions si heu de coure més d'un plat alhora.

Cocció amb ventilador

Sempre que pugueu, feu servir funcions de cocció amb ventilador per estalviar energia.

Calor residual

El ventilador i el llum continuen funcionant. Quan apagueu l'aparell, la pantalla mostra

l'escalfor residual. Podeu fer servir l'escalfor per mantenir els aliments calents.

Quan la durada de la cocció sigui superior a 30 minuts, reduïu la temperatura de l'aparell a un mínim de 3 a 10 minuts abans d'acabar la cocció. La calor residual a l'interior de l'aparell continuarà cuinant.

Feu servir l'escalfor residual per escalfar altres plats.

Per mantenir els aliments calents

Escolliu la temperatura més baixa possible per utilitzar l'escalfor residual i mantenir els aliments calents. L'indicador d'escalfor residual o de temperatura es mostren a la pantalla.

Cocció sense llum

Apagueu el llum durant la cocció. Activeu-lo només quan el necessiteu.







Cocció amb ventilació

Funció dissenyada per estalviar energia durant la cocció.

Quan utilitzeu aquesta funció, el llum s'apaga automàticament després de 30 segons. Podeu tornar-lo a engegar però, si ho feu, reduïreu l'estalvi d'energia.

14. ESTRUCTURA DE MENÚ

14.1 Menú

Pas 1	Pas 2	Pas 3	Pas 4	Pas 5
				
 : seleccioneu per accedir al Menú.	Seleccioneu l'opció de l'estructura Menú i premeu OK .	Trieu l'ajust.	OK : premeu per confirmar l'ajust.	Ajusteu el valor i premeu OK .
Gireu el selector de les funcions d'escalfament fins a la posició d'apagat (OFF) per sortir del Menú.				

Estructura del Menú

Cocció assistida 

Neteja 

Configuració 

Configuració

01	Hora del dia	Canviar	02	Brillantor de la pantalla	1 - 5
03	Tons de les teclès	1: xiulet 2: clic 3: sense so	04	Volum del bronzidor	1 - 4
05	Temporitzador	Encendre/ apagar	06	Llum	Encendre/apagar
07	Escalfament ràpid	Encendre/ apagar	08	Recordatori de neteja	Encendre/apagar
09	Mode Demo	Codi d'activació: 2468	10	Versió del programari	Comprovar
11	Restaura tots els paràmetres	Sí / No			

15. QÜESTIONS MEDIAMBIENTALS

Recicleu els materials amb el símbol .
Dipositeu l'embalatge en contenidors adequats per al seu posterior reciclatge.
Ajudeu a protegir el medi ambient i la salut humana i a reciclar les deixalles procedents d'aparells elèctrics i electrònics. No llenceu a

les escombraries domèstiques els aparells amb el símbol . Porteu el producte a les instal·lacions de reciclatge locals o poseu-vos en contacte amb la seva oficina municipal.

Welkom bij AEG! Hartelijk dank dat je voor onze apparatuur hebt gekozen.



Advies over gebruik, brochures, het oplossen van problemen, onderhouds- en reparatie-informatie op aeg.com/support



Download de **My AEG Kitchen**-app voor meer recepten, hints en probleemoplossing.



Wijzigingen voorbehouden.

INHOUDSOPGAVE

1. VEILIGHEIDSINFORMATIE.....	27
2. VEILIGHEIDSVOORSCHRIFTEN.....	29
3. BESCHRIJVING VAN HET PRODUCT.....	33
4. BEDIENINGSPANEEL.....	34
5. VOORAFGAAND AAN HET EERSTE GEBRUIK.....	34
6. DAGELIJKS GEBRUIK.....	35
7. KLOKFUNCTIES.....	40
8. GEBRUIK VAN DE ACCESSOIRES.....	41
9. EXTRA FUNCTIES.....	42
10. AANWIJZINGEN EN TIPS.....	43
11. ONDERHOUD EN REINIGING.....	45
12. PROBLEEMOPLOSSING.....	49
13. ENERGIEZUINIGHEID.....	50
14. MENUSTRUCTUUR.....	51
15. MILIEUBESCHERMING.....	52

1. ⚠ VEILIGHEIDSINFORMATIE

Lees zorgvuldig de meegeleverde instructies voor installatie en gebruik van het apparaat. De fabrikant is niet verantwoordelijk voor verwondingen of schade die voortvloeit uit de onjuiste installatie of het onjuiste gebruik. Bewaar de instructies altijd op een veilige, toegankelijke plek voor toekomstig gebruik.

1.1 De veiligheid van kinderen en kwetsbare personen

- Dit apparaat kan worden gebruikt door kinderen van 8 jaar en ouder en door mensen met een beperkt lichamelijk,

zintuiglijk of verstandelijk vermogen of een gebrek aan ervaring en kennis, indien zij onder toezicht staan of instructies hebben gekregen over het veilig gebruiken van het apparaat en indien zij de gevaren begrijpen. Kinderen jonger dan 8 jaar en personen met zware en complexe beperkingen dienen altijd uit de buurt van het apparaat te worden gehouden, tenzij ze voortdurend onder toezicht staan.

- Houd toezicht op kinderen om te voorkomen dat zij met het apparaat gaan spelen..
- Houd alle verpakking uit de buurt van kinderen en gooi het op passende wijze weg.
- **WAARSCHUWING:** Het apparaat en de toegankelijke onderdelen ervan worden heet tijdens het gebruik. Houd kinderen en huisdieren uit de buurt van het apparaat tijdens het gebruik en bij het afkoelen.
- Als het apparaat is voorzien van een kinderslot, dient dit te worden geactiveerd.
- Kinderen mogen zonder toezicht geen reinigings- en onderhoudswerkzaamheden aan het apparaat uitvoeren.

1.2 Algemene veiligheid

- Dit apparaat is uitsluitend bestemd om mee te koken.
- Dit apparaat is bedoeld voor binnenshuis huishoudelijk gebruik.
- Dit apparaat kan worden gebruikt in kantoren, hotelkamers, bed & breakfast-kamers, boerderijgasthuizen en andere soortgelijke accommodaties waar dergelijk gebruik de (gemiddelde) huishoudelijke gebruiksniveaus niet overschrijdt.
- Alleen een erkende installatietechnicus mag dit apparaat installeren en de kabel vervangen.
- Gebruik het apparaat niet voordat u het in de ingebouwde constructie installeert.
- Trek de stekker van het apparaat uit het stopcontact voordat u welke soort onderhoud dan ook gaat uitvoeren.

- Als het netsnoer beschadigd is, moet de fabrikant, een erkend servicecentrum of een gekwalificeerde persoon deze vervangen teneinde gevaarlijke situaties met elektriciteit te voorkomen.
- **WAARSCHUWING:** Zorg ervoor dat het apparaat is uitgeschakeld voordat u de lamp vervangt om elektrische schokken te voorkomen.
- **WAARSCHUWING:** Het apparaat en de toegankelijke onderdelen ervan worden heet tijdens het gebruik. Zorg ervoor dat je de verwarmingselementen of het oppervlak van de apparaatruimte niet aanraakt.
- Gebruik altijd ovenhandschoenen om accessoires of ovenschalen te verwijderen of erin te plaatsen.
- Om de inschuifrailen te verwijderen trek eerst de voorkant van de inschuifrail en dan de achterkant uit de zijwanden. Plaats de inschuifrails in omgekeerde volgorde.
- Gebruik geen stoomreiniger om het apparaat schoon te maken.
- Gebruik nooit agressieve reinigingsmiddelen of scherpe metalen schrapers om de glazen deur schoon te maken. Deze kunnen krassen veroorzaken op het oppervlak, waardoor het glas zou kunnen breken.
- Haal, vóór pyrolytische reiniging, alle accessoires en overmatige afzettingen/morsingen uit de ovenruimte van het apparaat.

2. VEILIGHEIDSVOORSCHRIFTEN

2.1 Installeren



WAARSCHUWING!

Alleen een erkende installatietechnicus mag dit apparaat installeren.

- Verwijder alle verpakkingsmaterialen.
- Installeer en gebruik geen beschadigd apparaat.
- Volg de installatie-instructies die zijn meegeleverd met het apparaat.
- Pas altijd op bij verplaatsing van het apparaat, want het is zwaar. Gebruik altijd veiligheidshandschoenen en gesloten schoeisel.
- Trek het apparaat nooit aan de handgreep van zijn plaats.
- Installeer het apparaat op een veilige en geschikte plaats die aan alle installatie-eisen voldoet.
- Houd de minimumafstand naar andere apparaten en units in acht.

- Controleer, voordat je het apparaat monteert, of de ovendeur onbelemmerd opent.
- Het apparaat is uitgerust met een elektrisch koelsysteem. Het moet worden gebruikt met de elektrische voeding.
- De inbouwunit moet voldoen aan de stabiliteitsvereisten van DIN 68930.

Minimumhoogte kast (Minimumhoogte kast onder werkblad)	578 (600) mm
Kastbreedte	560 mm
Kastdiepte	550 (550) mm
Hoogte van de voorkant van het apparaat	594 mm
Hoogte van de achterkant van het apparaat	576 mm
Breedte van de voorkant van het apparaat	595 mm
Breedte van de achterkant van het apparaat	559 mm
Diepte van het apparaat	567 mm
Ingebouwde diepte van het apparaat	546 mm
Diepte met open deur	1027 mm
Minimumgrootte ventilatieopening. Opening geplaatst aan de onderkant van de achterzijde	560x20 mm
Lengte netvoedingskabel. Kabel wordt in de rechterhoek van de achterzijde geplaatst	1500 mm
Bevestigingsschroeven	4x25 mm

2.2 Elektrische aansluiting



WAARSCHUWING!

Gevaar voor brand en elektrische schokken.

- Alle elektrische aansluitingen moeten door een gediplomeerd elektromonteur worden gemaakt.
- Dit apparaat moet worden aangesloten op een geaard stopcontact.

- Zorg ervoor dat de parameters op het vermogensplaatje overeenkomen met elektrische vermogen van de netstroom.
- Gebruik altijd een juist geïnstalleerd schokbestendig stopcontact.
- Gebruik geen adapters met meerdere stekkers en verlengkabels.
- Zorg dat u de netstekker en het netsnoer niet beschadigt. Indien de voedingskabel moet worden vervangen, dan moet dit gebeuren door onze Klantenservice.
- Laat de stroomkabel niet in aanraking komen met de deur van het apparaat of de niche onder het apparaat, met name niet als deze werkt of als de deur heet is.
- De schokbescherming van delen onder stroom en geïsoleerde delen moet op zo'n manier worden bevestigd dat het niet zonder gereedschap kan worden verplaatst.
- Steek de stekker pas in het stopcontact als de installatie is voltooid. Zorg ervoor dat het netsnoer na installatie bereikbaar is.
- Als het stopcontact los zit, mag u de stekker niet in het stopcontact steken.
- Trek niet aan het netsnoer om het apparaat los te koppelen. Trek altijd aan de stekker.
- Gebruik enkel correcte isolatievoorzieningen: stroomonderbrekers, zekeringen (schroefzekeringen moeten uit de houder worden verwijderd), aardlekschakelaars en contactgevers.
- De elektrische installatie moet een isolatieapparaat bevatten waardoor het apparaat volledig van het lichtnet afgesloten kan worden. Het isolatieapparaat moet een contactopening hebben met een minimale breedte van 3 mm.
- Sluit de deur van het apparaat volledig voordat u de stekker in het stopcontact steekt.
- Dit apparaat wordt geleverd met een stekker en een netsnoer.

2.3 Gebruik

WAARSCHUWING!

Gevaar voor letsel, brandwonden, elektrische schokken of een explosie.

- De specificatie van dit apparaat niet wijzigen.
- Zorg ervoor dat de ventilatieopeningen niet geblokkeerd worden.
- Laat het apparaat tijdens de werking niet onbeheerd achter.
- Schakel het apparaat na elk gebruik uit.
- Wees voorzichtig met het openen van de deur van het apparaat wanneer het apparaat in werking is. Er kan hete lucht vrijkomen.
- Gebruik het apparaat niet met natte handen of als het contact maakt met water.
- Oefen geen druk uit op de open deur.
- Gebruik het apparaat niet als werkblad of als opslagoppervlak.
- Open de deur van het apparaat voorzichtig. Het gebruik van ingrediënten met alcohol kan een mengsel van alcohol en lucht veroorzaken.
- Laat geen vonken of open vlammen in contact met het apparaat komen wanneer u de deur opent.
- Plaats geen ontvlambare producten of artikelen die vochtig zijn met ontvlambare producten in, bij of op het apparaat.

WAARSCHUWING!

Risico op schade aan het apparaat.

- Om schade of verkleuring van het email te voorkomen:
 - plaats ovenschalen of andere voorwerpen niet rechtstreeks op de bodem van het apparaat.
 - leg geen aluminiumfolie op de bodem van de ruimte in het apparaat.
 - plaats geen water direct in het hete apparaat.
 - bewaar geen vochtige gerechten en voedsel in het apparaat nadat u klaar bent met koken.
 - wees voorzichtig bij het verwijderen of bevestigen van accessoires.

- Verkleuring van het email of roestvrij staal is niet van invloed op de werking van het apparaat.
- Gebruik een diepe pan voor vochtige taarten. Vruchtensappen veroorzaken vlekken die permanent kunnen zijn.
- Kook altijd met de deur van het apparaat gesloten.
- Als het apparaat achter een meubelpaneel gemonteerd is (bijv. een deur), zorg er dan voor dat de deur nooit gesloten is als het apparaat in werking is. Warmte en vocht kunnen achter een gesloten meubelpaneel ophopen en schade aan het apparaat, de behuizing of de vloer veroorzaken. Sluit het meubelpaneel niet tot het apparaat compleet is afgekoeld na gebruik.

2.4 Onderhoud en reiniging

WAARSCHUWING!

Gevaar voor letsel, vuur of schade aan het apparaat.

- Schakel het apparaat uit en trek de stekker uit het stopcontact voordat je onderhoudshandelingen verricht.
- Zorg ervoor dat het apparaat is afgekoeld. Er bestaat een risico dat de glasplaten kunnen breken.
- Vervang direct de glazen deurpanelen als deze beschadigd zijn. Neem contact op met een erkend servicecentrum.
- Wees voorzichtig als u de deur van het apparaat verwijdert. De deur is zwaar!
- Reinig het apparaat regelmatig om te voorkomen dat het materiaal van het oppervlak achteruitgaat.
- Reinig het apparaat met een vochtige zachte doek. Gebruik alleen neutrale schoonmaakmiddelen. Gebruik geen schuurmiddelen, schuursponsjes, oplosmiddelen of metalen voorwerpen.
- Volg als u een ovenspray gebruikt de aanwijzingen op de verpakking.

2.5 Pyrolytische reiniging

WAARSCHUWING!

Risico op letsel / Brand / Chemische uitstoot (dampen) in pyrolytische modus.

- Voor het uitvoeren van de pyrolytische reiniging en de eerste voorverwarming dient u het volgende uit de ovenruimte te verwijderen:
 - overtollig voedselresten, olie- of vetresten/afzettingen.
 - alle verwijderbare voorwerpen (inclusief planken, zijrails, enz., die bij het apparaat zijn geleverd), met name alle antiaanbakpotten, pannen, dienbladen, keukengerei, enz.
- Lees zorgvuldig alle instructies voor pyrolytische reiniging.
- Houd kinderen uit de buurt van het apparaat als de pyrolytische reiniging in werking is. Het apparaat wordt zeer heet en er komt hete lucht vrij uit de voorste koelopeningen.
- Pyrolytische reiniging gebeurt op hoge temperaturen waarbij dampen kunnen vrijkomen van kookresten en constructiematerialen. Om die reden adviseren wij consumenten:
 - zorg voor goede ventilatie tijdens en na de pyrolytische reiniging.
 - zorg voor goede ventilatie tijdens en na de eerste voorverwarming.
- Tijdens en na de pyrolytische reiniging mag u geen water op de ovendeur morsen of aanbrengen om beschadiging van de glasplaten te voorkomen.
- Rookgassen die vrijkomen uit alle pyrolytische ovens / kookresten zoals beschreven, zijn niet schadelijk voor mensen, inclusief kinderen of personen met medische aandoeningen.
- Houd huisdieren uit de buurt van het apparaat tijdens en na de pyrolytische reiniging en de initiële voorverwarming. Kleine huisdieren (vooral vogels en reptielen) kunnen zeer gevoelig zijn voor temperatuurveranderingen en uitgestoten dampen.
- Antiaanbaklagen in potten, pannen, bakplaten, bakgerei, enz. kunnen worden beschadigd door de hoge temperatuur van de pyrolytische reiniging van alle pyrolytische ovens. Ook kunnen ze een

bron zijn voor schadelijke dampen op laag niveau.

2.6 Binnenverlichting

WAARSCHUWING!

Gevaar voor elektrische schokken.

- Met betrekking tot de lamp(en) in dit product en reservelampen die afzonderlijk worden verkocht: Deze lampen zijn bedoeld om bestand te zijn tegen extreme fysieke omstandigheden in huishoudelijke apparaten, zoals temperatuur, trillingen, vochtigheid, of zijn bedoeld om informatie te geven over de operationele status van het apparaat. Ze zijn niet bedoeld voor gebruik in andere toepassingen en zijn niet geschikt voor verlichting in huishoudelijke ruimten.
- Dit product bevat een lichtbron van energie-efficiëntieklasse G.
- Gebruik alleen lampjes met dezelfde specificaties.

2.7 Service

- Neem contact op met de erkende servicedienst voor reparatie van het apparaat.
- Gebruik alleen originele reserveonderdelen.

2.8 Verwijdering

WAARSCHUWING!

Gevaar voor letsel of verstikking.

- Neem contact op met uw plaatselijke overheid voor informatie over het afvoeren van het apparaat.
- Haal de stekker uit het stopcontact.
- Snijd het netsnoer vlak bij het apparaat af en gooi het weg.
- Verwijder de deurvergrendeling om te voorkomen dat kinderen of huisdieren binnen in het apparaat vast komen te zitten.

3. BESCHRIJVING VAN HET PRODUCT

3.1 Algemeen overzicht

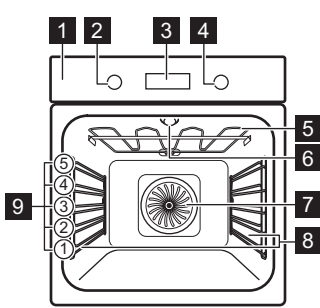

- 1 Bedieningspaneel
- 2 Knop voor verwarmingsfuncties
- 3 Display
- 4 Bedieningsknop
- 5 Verwarmingselement
- 6 Lamp
- 7 Ventilator
- 8 Inschuifrails, verwijderbaar
- 9 Inzetniveaus

3.2 Accessoires

Bakrooster

Voor kookgerei, bak- en braadvormen.

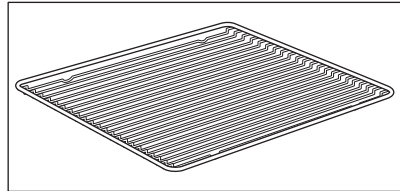

Bakplaat

Voor gebak en koekjes.

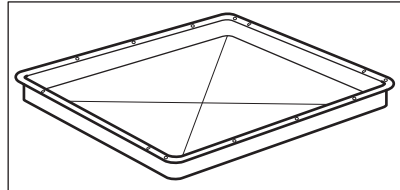

Grill-/braadpan

Om te bakken en braden of als een pan om vet in op te vangen.

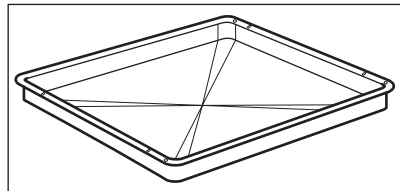

4. BEDIENINGSPANEEL

4.1 Verzonken knoppen

Om het apparaat te bedienen, moet u de bedieningsknop indrukken. De knop komt dan naar buiten.

4.2 Overzicht bedieningspaneel

Selecteer een verwarmingsfunctie om het apparaat in te schakelen. Draai de knop voor de verwarmingsfuncties naar de uit-stand om het apparaat uit te schakelen.

				
Timer	Snel opwarmen	Binnenverlichting	Slot	Instelling bevestigen



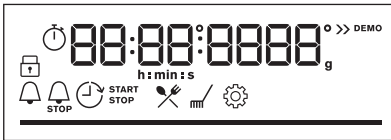

4.3 Display



Display met toetsfuncties.

Indicatielampjes op de display

Basisindicatoren

				
Blokkering	Kook- En Bakassistent	Reinigen	Instellingen	Snel opwarmen

Indicatielampjes timer

			
Kookwekker	Eindtijd	Uitsteltijd	Uptimer

Voortgangsbalk – voor temperatuur of tijd. De balk is volledig rood wanneer de oven de ingestelde temperatuur bereikt.

5. VOORAFGAAND AAN HET EERSTE GEBRUIK

WAARSCHUWING!

Raadpleeg de hoofdstukken Veiligheid.

5.1 Eerste reiniging

Reinig vóór het eerste gebruik het lege apparaat en stel de tijd in:



00:00

Stel de tijd in. Druk op **OK**.

5.2 Eerste voorverwarming

Warm de lege oven voor het eerste gebruik voor.

Stap 1 Haal alle accessoires en verwijderbare inschuifrails uit de oven.

Stap 2 Stel de maximale temperatuur in voor de functie: 
Laat de oven 1u werken.

Stap 3 Stel de maximale temperatuur in voor de functie: 
Laat de oven 15min werken.

 De oven kan een vreemde geur en rook afgeven tijdens het voorverwarmen. Zorg ervoor dat de kamer goed is geventileerd.

6. DAGELIJKS GEBRUIK



WAARSCHUWING!

Raadpleeg de hoofdstukken Veiligheid.

6.1 Instellen: Verwarmingsfuncties

Stap 1 Draai aan de knop van de verwarmingsfuncties om een verwarmingsfunctie te selecteren.

Stap 2 Draai aan de regelknop om de temperatuur in te stellen.









6.2 Verwarmingsfuncties

Verwarmingsfunctie	Toepassing
--------------------	------------



Hetelucht

Om op max. 3 rekstanden tegelijk te bakken en voedsel te drogen. Stel de temperatuur 20 - 40 °C lager in dan voor Boven + onderwarmte.

Verwarmingsfunctie	Toepassing
 Boven + onderwarmte	Voor het bakken en roosteren op één ovenniveau.
 Bevroren gerechten	Om kant-en-klaar-gerechten (bijv. patat, aardappelpartjes of loempia's) krokant te maken.
 Pizza-functie	Voor het bakken van pizza. Voor intensieve bruining en een krokante bodem.
 Onderwarmte	Voor het bakken van taarten met een krokante bodem en het bewaren van voedsel.
 Ontdooien	Om voedsel te ontdooien (groenten en fruit). De ontdooitijd is afhankelijk van de hoeveelheid ingevroren voedsel en de grootte daarvan.
 Warmelucht (vochtig)	Deze functie is ontworpen om energie te besparen tijdens het koken. Als u deze functie gebruikt, kan de temperatuur in het apparaat afwijken van de ingestelde temperatuur. De restwarmte wordt gebruikt. Het verwarmingsvermogen kan worden verlaagd. Raadpleeg voor meer informatie het hoofdstuk 'Dagelijks gebruik', Opmerkingen bij: Warmelucht (vochtig).
 Grillen	Om dunne stukken voedsel te grillen en brood te roosteren.
 Circulatiegrill	Voor het braden van grote stukken vlees of gevogelte met bot op één niveau. Voor gratineren en bruinen.
 Menu	Om het menu te openen: Kook- En Bakassistent, Reinigen, Instellingen.

6.3 Opmerkingen over: Warmelucht (vochtig)

Deze functie werd gebruikt om te voldoen aan de eisen van de energie-efficiëntieklasse en het ecologisch ontwerp (volgens EU 65/2014 en EU 66/2014). Tests volgens: IEC/EN 60350-1.

De ovendeur dient tijdens de bereiding gesloten te zijn zodat de functie niet wordt onderbroken en de oven werkt op de hoogst mogelijke energie-efficiëntie.







Bij gebruik van deze functie gaat de verlichting na 30 seconden automatisch uit.

Voor de bereidingsinstructies raadpleegt u het hoofdstuk "Aanwijzingen en tips", Warmelucht (vochtig). Voor algemene aanbevelingen voor energiebesparing raadpleegt u het hoofdstuk "Energie-efficiëntie", Energiebesparing.

6.4 Instellen:Kook- En Bakassistent



Elk gerecht in dit submenu heeft een aanbevolen verwarmingsfunctie en temperatuur. Gebruik de functie om snel een gerecht met standaardinstellingen te bereiden. Je kunt ook de tijd en de temperatuur tijdens het koken aanpassen.







Als de functie is afgelopen, controleert u of het voedsel klaar is.

















Voor sommige gerechten kunt u ook koken met:		• Per gewicht	
Stap 1	Stap 2	Stap 3	Stap 4
			
		P1 - P...	OK
Open het menu.	Selecteer Kook- En Bak-assistent. Druk op OK.	Selecteer de schaal. Druk op OK.	Plaats de schaal in de oven. Instelling bevestigen.

























6.5 Kook- En Bakassistent





Legenda	
	Per gewicht beschikbaar.

Legenda	
	Verwarm het apparaat voor voordat je begint met koken.
	Lagerniveau.

Gerecht	Gewicht	Schappniveau/accessoire
P1 Biefstuk, rauw		
P2 Biefstuk: medium	1 - 1.5 kg; 4 - 5 cm dikke stukken	 2; bakplaat Bak het vlees een paar minuten in een hete pan. Plaats in het apparaat.
P3 Biefstuk, gaar		
P4 Biefstuk, medium	180 - 220 g per stuk; 3 cm dikke plakken	  3 braadschaal op bakrooster Bak het vlees een paar minuten in een hete pan. Plaats in het apparaat.
P5 Rundvlees geroosterd/gestoofd (prime rib, bovenste ronde, dikke flank)	1.5 - 2 kg	  2 braadschaal op bakrooster Bak het vlees een paar minuten in een hete pan. Vloeistof toevoegen. Plaats in het apparaat.
P6 Biefstuk, rauw (langzaam koken)		
P7 Biefstuk, medium (langzaam koken)	1 - 1.5 kg; 4 - 5 cm dikke stukken	 2; bakplaat Gebruik je favoriete kruiden of gewoon zout en vers gemalen peper. Bak het vlees een paar minuten in een hete pan. Plaats in het apparaat.
P8 Biefstuk, gaar (langzaam koken)		





	Gerecht	Gewicht	Schaphniveau/accessoire
P9	Rundvleesfilet, gaar (lage temperatuur garen)		
P10	Filet, gemiddeld (lage temperatuur garen)	0,5 - 1,5 kg; 5 - 6 cm dikke stukken	 2; bakplaat Gebruik je favoriete kruiden of gewoon zout en vers gemalen peper. Bak het vlees een paar minuten in een hete pan. Plaats in het apparaat.
P11	Rundvleesfilet, gaar (lage temperatuur garen)		
P12	Geroosterd kalfsvlees (bijv. schouder)	0,8 - 1,5 kg; 4 cm dikke stukken	  2 braadschaal op bakrooster Gebruik je favoriete kruiden. Vloeistof toevoegen. Geroosterd bedekt.
P13	Geroosterde varkenshals of schouder	1,5 - 2 kg	  2 braadschaal op bakrooster Draai halverwege de bereidingstijd het vlees om.
P14	Aangetrokken varkensvlees (lage temperatuur garen)	1,5 - 2 kg	 2; bakplaat Gebruik je favoriete kruiden. Draai het vlees na halverwege de bereidingstijd, om een gelijkmatige bruining te krijgen.
P15	Varkenslende, vers	1 - 1,5 kg; 5 - 6 cm dikke stukken	 2; braadschaal op bakrooster Gebruik je favoriete kruiden.
P16	Reserverribben varkensvlees	2 - 3 kg; gebruik rauwe, 2 - 3 cm dunne spare ribs	 3; diepe pan Voeg vloeistof toe om de bodem van een schaal te bedekken. Draai halverwege de bereidingstijd het vlees om.
P17	Lambeen met botten	1,5 - 2 kg; 7 - 9 cm dikke stukken	 2; braadschaal op bakplaat Vloeistof toevoegen. Draai halverwege de bereidingstijd het vlees om.
P18	Hele kip	1 - 1,5 kg; vers	  2; stoofschotel op bakplaat Gebruik je favoriete kruiden. Draai de kip halverwege de bereidingstijd om voor een gelijkmatige bruining.
P19	Halve kip	0,5 - 0,8 kg	 3; bakplaat Gebruik je favoriete kruiden.
P20	Kippenborst	180 - 200 g per stuk	  2 stoofschotel op bakrooster Gebruik je favoriete kruiden. Bak het vlees een paar minuten in een hete pan.
P21	Kippenpoten, vers	-	 3; bakplaat Als u eerst kippenpoten hebt gemarineerd, stel dan een lagere temperatuur in en kook ze langer.
P22	Hele eend	2 - 3 kg	  2 braadschaal op bakrooster Gebruik je favoriete kruiden. Leg het vlees op de braadschaal. Draai halverwege de bereidingstijd de eend om.

	Gerecht	Gewicht	Schaphniveau/accessoire
P23	Gans, heel	4 - 5 kg	  2; diepe pan Gebruik je favoriete kruiden. Leg het vlees op een diepe bakplaat. Draai halverwege de bereidingstijd de gans om.
P24	Vleesbrood	1 kg	 2; bakrooster Gebruik je favoriete kruiden.
P25	Hele vis, gegrild	0.5 - 1 kg per vis	 2; bakplaat Vul de vis met boter en gebruik je favoriete kruiden en specerijen.
P26	Visfilet	-	  3 stoomschotel op bakrooster Gebruik je favoriete kruiden.
P27	Cheesecake	-	 2;  28 cm springvorm van op bakrooster
P28	Appelcake	-	 3; bakplaat
P29	Appeltaart	-	 2; taartvorm op bakrooster
P30	Appeltaart	-	 1 taartvorm op  22 cm bakrooster
P31	Brownies	2 kg van deeg	 3; diepe pan
P32	Chocolade muffins	-	 3 muffinbakplaat op bakrooster
P33	Broodcake	-	 2; broodvorm op bakrooster
P34	Gebakken aardappelen	1 kg	 2; bakplaat Leg de gesneden aardappelen met huid op de bakplaat.
P35	Aardappelpartjes	1 kg	 3; bakplaat bedekt met bakpapier Gebruik je favoriete kruiden. Snijd aardappelen in stukken.
P36	Gegrilde gemengde groenten	1 - 1.5 kg	 3; bakplaat bedekt met bakpapier Gebruik je favoriete kruiden. Snijd de groenten in stukken.
P37	Aardappelkroketjes, bevroren	0.5 kg	 3; bakplaat
P38	Patat, bevroren	0.75 kg	 3; bakplaat
P39	Vlees-/groentelasagne met droge pasta-bladen	1 - 1.5 kg	 2; stoomschotel op bakrooster
P40	Aardappelgratin (ruwe aardappelen)	1 - 1.5 kg	 1; stoomschotel op bakrooster Draai het gerecht na de helft van de bereidingstijd.
P41	Verse pizza, dun	-	  2; bakplaat bedekt met bakpapier



Gerecht	Gewicht	Schapniveau/accessoire
P42 Verse pizza, dik	-	 2; bakplaat bedekt met bakpapier
P43 Quiche	-	 2; bakblik op bakrooster
P44 Stokbrood / ciabatta / witbrood	0.8 kg	 2; bakplaat bedekt met bakpapier Meer tijd nodig voor witbrood.
P45 Volkoren / rogge / bruin brood	1 kg	 2; bakplaat bedekt met bakpapier / bakrooster

7. KLOKFUNCTIES

7.1 Klokfuncties

Klokfunctie	Toepassing
 Kookwekker	Wanneer de tijd is verstreken, klinkt er een geluidssignaal.
 Kooktijd	Wanneer de timer stopt, klinkt het signaal en stopt de verwarmingsfunctie.
 Uitsteltijd	Om het begin en/of het einde van het koken uit te stellen.
 Uptimer	Maximum is 23 uur 59 min. Deze functie heeft geen invloed op de werking van de oven. Om de Uptimer in en uit te schakelen, selecteer: Menu, Instellingen.

7.2 Instellen: Klokfuncties

Instellen: Dagtijd		
Stap 1	Stap 2	Stap 3
		
Om de tijd van de dag te wijzigen, opent u het menu en selecteert u Instellingen, Dagtijd.	Stel de klok in.	Druk op: OK .

Instellen: Kookwekker

Stap 1



Druk op: 

Op het display
verschijnt:
0:00

Stap 2



Stel de Kookwekker in

Stap 3



Druk op: OK.

 De timer begint onmiddellijk af te tellen.

Instellen: Kooktijd

Stap 1



Kies een verwarmings-
functie en stel de tem-
peratuur in.

Stap 2



Druk herhaaldelijk:

Op het display
verschijnt:
0:00

STOP

Stap 3



Stel de bereidingstijd
in.

Stap 4



Druk op: OK.

 De timer begint onmiddellijk af te tellen.

Instellen: Uitsteltijd

Stap 1



Selecteer
de verwar-
mingsfunc-
tie.

Stap 2



Druk herhaal-
delijk: 

Stap 3



Stel de start-
tijd in.

Stap 4



Druk op:
OK.

Het display
toont: de
dagtijd
 STAR-
TEN

Op het dis-
play ver-
schijnt:
--:--
 STOP

Stap 5



Stel de
eindtijd in.

Stap 6



Druk op:
OK.

 De timer begint af te tellen op een ingestelde starttijd.

8. GEBRUIK VAN DE ACCESSOIRES

WAARSCHUWING!

Raadpleeg de hoofdstukken Veiligheid.

8.1 Accessoires plaatsen

Een kleine inkeping bovenaan verhoogt de veiligheid. De inkepingen zijn ook anti-

kantelmechanismen. De hoge rand rond het rooster voorkomt dat het kookgerei van het rooster afglijdt.

Bakrooster:

Plaats het rooster tussen de geleidestangen van de roostersteun.

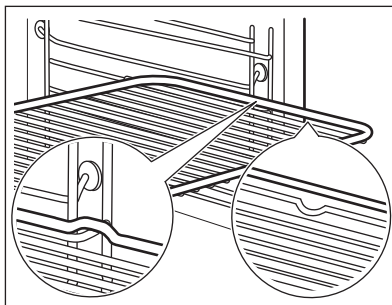
**Bakplaat / Diepe schaal:**

Schuif de plaat tussen de geleidestangen van de inschuifrail.

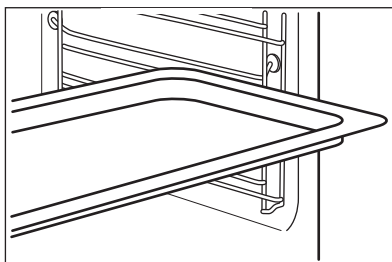

9. EXTRA FUNCTIES

9.1 Blokkering

Deze functie voorkomt dat de functie van het apparaat per ongeluk wordt gewijzigd.

Schakel het in als het apparaat werkt – de ingestelde bereiding gaat door, het bedieningspaneel wordt vergrendeld.

Schakel het in als het apparaat is uitgeschakeld – het kan niet worden ingeschakeld, het bedieningspaneel is vergrendeld.



– houd ingedrukt om de functie in te schakelen.
een geluidssignaal.



– houd ingedrukt om het uit te schakelen.

i 3 x – knippert wanneer de vergrendeling wordt ingeschakeld.

9.2 Automatische uitschakeling

Als de verwarmingsfunctie actief is en er geen instellingen worden gewijzigd, wordt het apparaat om veiligheidsredenen na een bepaalde periode automatisch uitgeschakeld.

(°C)	(u)
30 - 115	12.5
120 - 195	8.5
200 - 245	5.5



250 - maximaal



3

De automatische uitschakeling werkt niet met de functies: Binnenverlichting, Uitsteltijd .

9.3 Koelventilator

Als het apparaat in werking is, wordt de koelventilator automatisch ingeschakeld om de oppervlakken van het apparaat koel te houden. Als je het apparaat uitschakelt, kan de koelventilator blijven werken totdat het apparaat is afgekoeld.

10. AANWIJZINGEN EN TIPS

10.1 Kookadviezen





De temperatuur en kooktijden in de tabellen zijn slechts als richtlijn bedoeld. Ze zijn afhankelijk van het recept, de kwaliteit en de kwantiteit van de gebruikte ingrediënten.

Je apparaat kan anders bakken of roosteren dan het apparaat dat je tot nu toe gebruikt hebt. De onderstaande hints tonen aanbevolen instellingen voor temperatuur, kooktijd en rekstand voor specifieke soorten voedsel.

Als u voor een speciaal recept de instelling niet kunt vinden, zoek dan naar een soortgelijk recept.

10.2 Warmelucht (vochtig)

Volg voor de beste resultaten de volgende aanwijzingen op die hieronder in de tabel staan.

	°C		
Pastagratin	200 - 220	45 - 55	3
Aardappelgratin	180 - 200	70 - 85	3
Moussaka	170 - 190	70 - 95	3
Lasagne	180 - 200	75 - 90	3
Cannelloni	180 - 200	70 - 85	3
Broodpudding	190 - 200	55 - 70	3
Rijstpudding	170 - 190	45 - 60	3
Appeltaart, gemaakt van zacht cakedeeg (ronde taartvorm)	160 - 170	70 - 80	3
Witbrood	190 - 200	55 - 70	3

10.3 Warmelucht (vochtig) – aanbevolen accessoires

Gebruik de donkere en niet-reflecterende bakjes en schalen. Ze nemen de warmte beter op dan licht en reflecterend servies.



Pizza pan

Donker, niet-reflecterend
Diameter van 28 cm

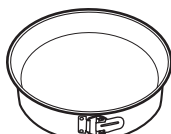

Ovenschaal

Donker, niet-reflecterend
Diameter van 26 cm



Ovenvormpjes

Keramik
8 cm diameter, 5
cm hoog



Blik voor flanbodem





Donker, niet-reflecterend
Diameter van 28 cm

10.4 Kooktafels voor testinstituten

Informatie voor testinstituten





Testen in overeenstemming met: EN 60350, IEC 60350.

Bakken op één niveau - bakken in bakblikken





		 °C	 min	
Zachte cake zonder vet	Hetelucht	160	45 - 60	2
Zachte cake zonder vet	Boven + onderwarmte	160	45 - 60	2
Appeltaart, 2 blikken Ø20 cm	Hetelucht	160	55 - 65	2
Appeltaart, 2 blikken Ø20 cm	Boven + onderwarmte	180	55 - 65	1
Zandtaartdeeg	Hetelucht	140	25 - 35	2
Zandtaartdeeg	Boven + onderwarmte	140	25 - 35	2

Bakken op één niveau - koekjes

Gebruik de derde rekstand.

		 °C	 min
Kleine cakes, 20 stuks per bakplaat, verwarm de lege oven voor	Hetelucht	150	20 - 30
Kleine cakes, 20 stuks per bakplaat, verwarm de lege oven voor	Boven + onderwarmte	170	20 - 30





Bakken op meerdere niveaus - koekjes

		 °C	 min	
Zandtaartdeeg	Hetelucht	140	25 - 45	2 / 4
Kleine cakes, 20 stuks per bakplaat, verwarm de lege oven voor	Hetelucht	150	25 - 35	1 / 4
Zachte cake zonder vet	Hetelucht	160	45 - 55	2 / 4
Appeltaart, 1 blik per rooster (Ø 20 cm)	Hetelucht	160	55 - 65	2 / 4

Grillen

Verwarm de lege oven 5 minuten voor.

Grill met de maximale temperatuurinstelling.

		 min	
Toast	Grillen	1 - 2	5
Biefstuk, halverwege de bereidings-tijd omdraaien	Grillen	24 - 30	4

11. ONDERHOUD EN REINIGING



WAARSCHUWING!

Raadpleeg de hoofdstukken Veiligheid.

11.1 Opmerkingen over de reiniging



Reinigingsmid-
delen

Reinig de voorkant van het apparaat uitsluitend met een microvezeldoek met warm water en een mild reinigingsmiddel.

Gebruik een reinigungsoplossing om metalen oppervlakken te reinigen.

Reinig vlekken met een mild reinigingsmiddel.



Dagelijks gebruik

Reinig de uitsparing telkens na gebruik. Vetophoping of andere resten kunnen brand veroorzaken.

Bewaar het voedsel niet langer dan 20 minuten in het apparaat. Droog de ruimte na elk gebruik uitsluitend met een microvezeldoek.



Accessoires

Reinig alle accessoires na elk gebruik en laat ze drogen. Gebruik alleen een zachte doek met warm water en een mild reinigingsmiddel. De accessoires niet in een afwasmachine reinigen.

Reinig de antiaanbakaccessoires niet met agressieve reinigingsmiddelen of scherpe voorwerpen.

11.2 Hoe te verwijderen: Inschuifrails/

Verwijder de inschuifrails om de oven te reinigen.

Stap 1 Schakel de oven uit en wacht totdat deze is afgekoeld.

Stap 2 Trek de inschuifrail bij de voorkant uit de zijwand.

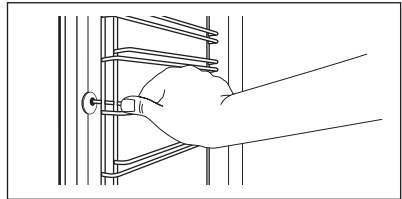

Stap 3 Trek de geleider bij de achterkant uit de zijwand en verwijder het.

Stap 4 Plaats de inschuifrails in omgekeerde volgorde.

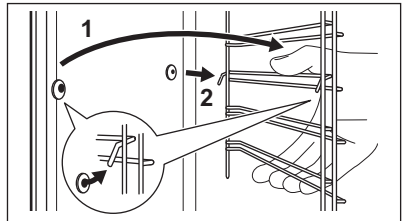

11.3 Hoe gebruikt u: Pyrolytische reiniging

Maak de oven schoon met Pyrolytische reiniging.

WAARSCHUWING!

Er bestaat gevaar voor brandwonden.

LET OP!

Als er andere apparaten in dezelfde kast zijn geïnstalleerd, gebruik deze dan niet tijdens deze functie. Dit kan de oven beschadigen.

Vóór de Pyrolytische reiniging:

Schakel de oven uit en wacht totdat deze is afgekoeld.

Verwijder alle accessoires uit de oven en de verwijderbare inschuifrails.

Reinig de onderkant van de oven en de glazen deur aan de binnenkant met warm water, een zachte doek en een mild reinigingsmiddel.

Pyrolytische reiniging

Stap 1

Ga naar het menu: Reinigen .

Optie	Duur
C1 - Licht reinigen	1 h
C2 - Normaal reinigen	1 h 30 min
C3 - Grondig reinigen	3 h

Stap 2

 - druk hierop om het reinigingsprogramma te selecteren.

Stap 3

 - druk hierop om het reinigen te starten.

Stap 4

Draai na de reiniging de knop voor de verwarmingsfuncties naar de uit-stand.

 Als het reinigen begint, wordt de deur van de oven vergrendeld en is de lamp uit. Totdat de deur wordt ontgrendeld, toont het display: .

Na afloop van het reinigen:

Schakel de oven uit en wacht totdat deze is afgekoeld.

Maak de ruimte schoon met een zachte doek.

Verwijder het residu van de bodem van de ruimte.

11.4 Reinigingsherinnering

De oven herinnert je eraan wanneer je hem moet schoonmaken met pyrolytische reiniging.

 knippert na elke kooksessie gedurende 5 seconden op het display.

Om de herinnering uit te schakelen, voert u de in Menu en selecteert u Instellingen, Reinigingsherinnering.

11.5 Verwijderen en installeren: Deur

U kunt de deur en de binnenste glasplaten verwijderen om ze te reinigen. U Het aantal glasplaten verschilt per model.

WAARSCHUWING!

De deur is zwaar.

LET OP!

Behandel het glas voorzichtig, vooral rond de randen van het voorpaneel. Het glas kan breken.

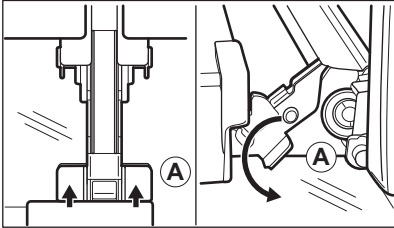
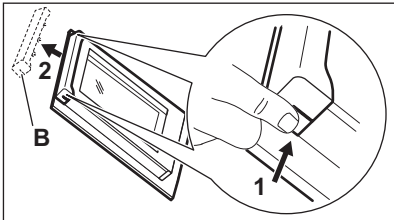
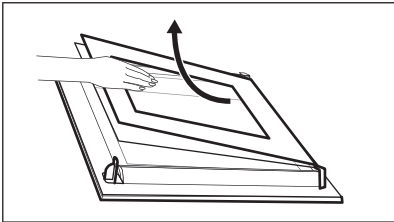
Stap 1	Open de deur volledig.	
Stap 2	Hef en druk de klemhendels (A) op de twee deurscharnieren.	
Stap 3	Sluit de ovendeur in de eerste openingsstand (in een hoek van ongeveer 70°). Houd de deur aan beide kanten vast en trek deze onder een opwaartse hoek weg van de oven. Plaats de ovendeur met de buitenkant omlaag op een zachte doek op een stabiele ondergrond.	
Stap 4	Pak de deurafdekking (B) aan de bovenkant van de deur aan beide kanten vast en druk deze naar binnen om de klemsluiting te ontgrendelen.	
Stap 5	Trek de deurlijst naar voren om hem te verwijderen.	
Stap 6	Houd de glasplaten aan hun bovenkant vast en trek deze een voor een omhoog uit de geleider.	
Stap 7	Reinig de glasplaat met een sopje. Droog de glasplaat voorzichtig af. Reinig de glasplaten niet in de vaatwasser.	
Stap 8	Voer na het reinigen de bovenstaande stappen in de omgekeerde volgorde uit.	
Stap 9	Plaats de kleinste glasplaat eerst, daarna de grotere glasplaat en de deur.	

11.6 Hoe te vervangen: Lamp



WAARSCHUWING!

Gevaar voor elektrische schokken.
Het lampje kan heet zijn.

Voordat u de lamp vervangt:

Stap 1	Stap 2	Stap 3
Schakel de oven uit. Wacht tot de oven afgekoeld is.	Trek de oven uit het stopcontact.	Plaats een doek op de bodem van de holte.

Bovenlamp

Stap 1 Draai de glazen afdekking om die te verwijderen.

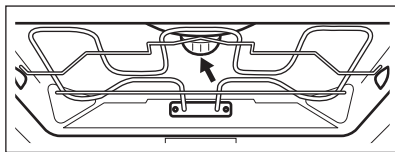

Stap 2 Reinig de glasafdekking.

Stap 3 Vervang de lamp door een geschikte 300 °C hittebestendige lamp.

Stap 4 Installeer het glazen deksel.

12. PROBLEEMOPLOSSING

WAARSCHUWING!

Raadpleeg de hoofdstukken Veiligheid.

12.1 Wat te doen als...

Neem in alle gevallen die niet in deze tabel zijn opgenomen contact op met een erkend servicecentrum.



Het apparaat gaat niet aan of warmt niet op

Probleem	Controleer of de volgende zaken van toepassing zijn...
U kunt het apparaat niet inschakelen of gebruiken.	Het apparaat is op de juiste manier op een elektrische toevoer aangesloten.
Het apparaat warmt niet op.	De automatische uitschakeling is gedeactiveerd.
Het apparaat warmt niet op.	De deur van het apparaat is gesloten.
Het apparaat warmt niet op.	De zekering is niet doorgeslagen.
Het apparaat warmt niet op.	Het slot is uitgeschakeld.



Onderdelen

Probleem	Controleer of de volgende zaken van toepassing zijn...
De lamp is uit.	Warmelucht (vochtig) - wordt ingeschakeld.
De verlichting werkt niet.	De lamp is opgebrand.



Foutcodes

Op het display verschijnt...	Controleer of de volgende zaken van toepassing zijn...
Err C3	De ovendeur is gesloten of het deurslot is niet kapot.
Err F102	De deur van het apparaat is gesloten.
Err F102	Het deurslot is niet kapot.
00:00	Er was een stroomstoring. Stel het tijdstip van de dag in.

Als het display een foutcode weergeeft die niet in deze tabel staat, schakelt u de zekering van het huis uit en weer in om de oven opnieuw te starten. Als de foutcode opnieuw optreedt, neemt u contact op met een erkend servicecentrum.

12.2 Service-informatie

Als je niet zelf het probleem kunt verhelpen, neem dan contact op met je verkoper of een erkende serviceafdeling.

De contactgegevens van de servicedienst staan op het typeplaatje. Het typeplaatje bevindt zich op het voorframe van de apparaatruimte. Verwijder het typeplaatje niet uit de apparaatruimte.

Wij raden je aan om de gegevens hier te noteren:

Model (MOD.)
Productnummer (PNC)
Serienummer (S.N.)

13. ENERGIEZUINIGHEID

13.1 Productinformatie en productinformatieblad volgens de EU-voorschriften voor ecologisch ontwerp en energie-etikettering

Naam leverancier	AEG
Modelnummer	BPK535060B 944188596 BPK535060M 944188597
Energie-efficiëntie-index	81.2
Energie-efficiëntieklasse	A+
Energieverbruik met een standaard belading, conventionele modus	1.09 kWh/cyclus
Energieverbruik met een standaard belasting, heteluchtmodus	0.69 kWh/cyclus
Aantal holtes	1
Warmtebron	Elektriciteit
Volume	71 l
Soort oven	Inbouwoven

Massa	BPK535060B	35.0 kg
	BPK535060M	35.0 kg

IEC/EN 60350-1 - Huishoudelijke elektrische kooktoestellen - Deel 1: Fornozen, ovens, stoomovens en grills - Methoden voor het meten van prestaties.

13.2 Energiebesparing



Dit apparaat heeft functies die u helpen energie te besparen tijdens het dagelijks koken.

Zorg ervoor dat de deur van het apparaat gesloten is als het apparaat in werking is. Open de deur van het apparaat niet te vaak tijdens het koken. Houd het deurrubber schoon en zorg ervoor dat het goed op zijn plaats vastzit.

Gebruik metalen kookgerei om meer energie te besparen.

Verwarm het apparaat niet voor alvorens te koken als dat niet hoeft.

Houd onderbrekingen tussen het bakken zo kort mogelijk als je een aantal gerechten tegelijkertijd bereidt.

Koken met hete lucht

Gebruik indien mogelijk de bereidingsfuncties met hete lucht om energie te besparen.

Restwarmte

De ventilator en lamp blijven werken.

Wanneer je de oven uitschakelt, geeft het display de restwarmte aan. U kunt die warmte gebruiken om het eten warm te houden.

Wanneer de kookduur langer is dan 30 minuten, verlaag dan de oventemperatuur tot minimaal 3-10 minuten voor het einde van het koken. De restwarmte binnen in het apparaat zal blijven koken.

Je kunt de restwarmte gebruiken om andere maaltijden op te warmen.

Eten warm houden

Kies de laagst mogelijke temperatuurinstelling om de restwarmte te gebruiken en een maaltijd warm te houden. Het indicatielampje van de restwarmte of temperatuur verschijnt op het display.

Koken met de verlichting uitgeschakeld

Schakel de verlichting tijdens het koken uit. Doe het aan als je het nodig hebt.

Warmelucht (vochtig)

Functie is ontworpen om tijdens de bereiding energie te besparen.

Als je deze functie gebruikt, gaat de verlichting na 30 sec. automatisch uit. Je kunt de verlichting weer inschakelen, maar deze handeling vermindert de verwachte energiebesparingen.

14. MENUSTRUCTUUR

14.1 Menu

Stap 1	Stap 2	Stap 3	Stap 4	Stap 5



- selecteer om de Menu.

Selecteer de optie in de Menu structuur en druk op **OK**.

Selecteer de instelling.

OK - druk op om de instelling te bevestigen.

Pas de waarde aan en druk op **OK**.

Draai de knop voor de verwarmingsfuncties naar de uit-stand om Menu af te sluiten.

Menu-structuur te betreden

Kook- En Bakassistent

Reinigen

Instellingen

Instellingen

01	Dagtijd	Wijzigen	02	Helderheid display	1 - 5
03	Toetstonen	1 - Piep 2 - Klik 3 - Geluid uit	04	Geluidsvolume	1 - 4
05	Uptimer	Aan/uit	06	Binnenverlichting	Aan/uit
07	Snel opwarmen	Aan/uit	08	Reinigingsherinnering	Aan/uit
09	Demofunctie	Activeringscode: 2468	10	Softwareversie	Controleren
11	Terug naar fabrieksinstellingen	Ja / Nee			

15. MILIEUBESCHERMING

Recycleer de materialen met het symbool . Gooi de verpakking in een geschikte afvalcontainer om het te recyclen. Bescherm het milieu en de volksgezondheid en recycleer op een correcte manier het afval van elektrische en elektronische apparaten.

Gooi apparaten gemarkeerd met het symbool niet weg met het huishoudelijk afval. Breng het product naar het milieustation bij u in de buurt of neem contact op met de gemeente.

Welcome to AEG! Thank you for choosing our appliance.



Get usage advice, brochures, trouble shooter, service and repair information at aeg.com/support



For more recipes, hints, troubleshooting download **My AEG Kitchen** app.



Subject to change without notice.

CONTENTS

1. SAFETY INFORMATION.....	53
2. SAFETY INSTRUCTIONS.....	55
3. PRODUCT DESCRIPTION.....	58
4. CONTROL PANEL.....	59
5. BEFORE FIRST USE.....	60
6. DAILY USE.....	60
7. CLOCK FUNCTIONS.....	65
8. USING THE ACCESSORIES.....	66
9. ADDITIONAL FUNCTIONS.....	67
10. HINTS AND TIPS.....	68
11. CARE AND CLEANING.....	70
12. TROUBLESHOOTING.....	74
13. ENERGY EFFICIENCY.....	75
14. MENU STRUCTURE.....	76
15. ENVIRONMENTAL CONCERNS.....	77

1. ⚠ SAFETY INFORMATION

Before the installation and use of the appliance, carefully read the supplied instructions. The manufacturer is not responsible for any injuries or damage that are the result of incorrect installation or usage. Always keep the instructions in a safe and accessible location for future reference.

1.1 Children and vulnerable people safety

- This appliance can be used by children aged from 8 years and above and persons with reduced physical, sensory or mental capabilities or lack of experience and knowledge if they have been given supervision or instruction concerning the use of the appliance in a safe way and understand the

hazards involved. Children of less than 8 years of age and persons with very extensive and complex disabilities shall be kept away from the appliance unless continuously supervised.

- Children should be supervised to ensure that they do not play with the appliance.
- Keep all packaging away from children and dispose of it appropriately.
- **WARNING:** The appliance and its accessible parts become hot during use. Keep children and pets away from the appliance when in use and when cooling down.
- If the appliance has a child safety device, it should be activated.
- Children shall not carry out cleaning and user maintenance of the appliance without supervision.

1.2 General Safety

- This appliance is for cooking purposes only.
- This appliance is designed for single household domestic use in an indoor environment.
- This appliance may be used in, offices, hotel guest rooms, bed & breakfast guest rooms, farm guest houses and other similar accommodation where such use does not exceed (average) domestic usage levels.
- Only a qualified person must install this appliance and replace the cable.
- Do not use the appliance before installing it in the built-in structure.
- Disconnect the appliance from the power supply before carrying out any maintenance.
- If the supply cord is damaged, it must be replaced by the manufacturer, its Authorised Service Centre or similarly qualified persons to avoid an electrical hazard.
- **WARNING:** Ensure that the appliance is switched off before replacing the lamp to avoid the possibility of electric shock.

- **WARNING:** The appliance and its accessible parts become hot during use. Care should be taken to avoid touching heating elements or the surface of the appliance cavity.
- Always use oven gloves to remove or insert accessories or ovenware.
- To remove the shelf supports first pull the front of the shelf support and then the rear end away from the side walls. Install the shelf supports in the opposite sequence.
- Do not use a steam cleaner to clean the appliance.
- Do not use harsh abrasive cleaners or sharp metal scrapers to clean the glass door since they can scratch the surface, which may result in shattering of the glass.
- Before pyrolytic cleaning, remove all accessories and excessive deposits/spills from the appliance cavity.

2. SAFETY INSTRUCTIONS

2.1 Installation

WARNING!

Only a qualified person must install this appliance.

- Remove all the packaging.
- Do not install or use a damaged appliance.
- Follow the installation instructions supplied with the appliance.
- Always take care when moving the appliance as it is heavy. Always use safety gloves and enclosed footwear.
- Do not pull the appliance by the handle.
- Install the appliance in a safe and suitable place that meets installation requirements.
- Keep the minimum distance from other appliances and units.
- Before mounting the appliance, check if the appliance door opens without restraint.
- The appliance is equipped with an electric cooling system. It must be operated with the electric power supply.
- The built-in unit must meet the stability requirements of DIN 68930.

Cabinet minimum height (Cabinet under the worktop minimum height)	578 (600) mm
Cabinet width	560 mm
Cabinet depth	550 (550) mm
Height of the front of the appliance	594 mm
Height of the back of the appliance	576 mm
Width of the front of the ap- pliance	595 mm
Width of the back of the ap- pliance	559 mm
Depth of the appliance	567 mm
Built in depth of the appli- ance	546 mm
Depth with open door	1027 mm
Ventilation opening mini- mum size. Opening placed on the bottom rear side	560x20 mm
Mains supply cable length. Cable is placed in the right corner of the back side	1500 mm

2.2 Electrical connection

WARNING!

Risk of fire and electric shock.

- All electrical connections should be made by a qualified electrician.
- The appliance must be earthed.
- Make sure that the parameters on the rating plate are compatible with the electrical ratings of the mains power supply.
- Always use a correctly installed shockproof socket.
- Do not use multi-plug adapters and extension cables.
- Make sure not to cause damage to the mains plug and to the mains cable. Should the mains cable need to be replaced, this must be carried out by our Authorised Service Centre.
- Do not let mains cables touch or come near the appliance door or the niche below the appliance, especially when it operates or the door is hot.
- The shock protection of live and insulated parts must be fastened in such a way that it cannot be removed without tools.
- Connect the mains plug to the mains socket only at the end of the installation. Make sure that there is access to the mains plug after the installation.
- If the mains socket is loose, do not connect the mains plug.
- Do not pull the mains cable to disconnect the appliance. Always pull the mains plug.
- Use only correct isolation devices: line protecting cut-outs, fuses (screw type fuses removed from the holder), earth leakage trips and contactors.
- The electrical installation must have an isolation device which lets you disconnect the appliance from the mains at all poles. The isolation device must have a contact opening width of minimum 3 mm.
- Fully close the appliance door before you connect the mains plug to the mains socket.
- This appliance is supplied with a main plug and a main cable.

2.3 Use

WARNING!

Risk of injury, burns and electric shock or explosion.

- Do not change the specification of this appliance.
- Make sure that the ventilation openings are not blocked.
- Do not let the appliance stay unattended during operation.
- Deactivate the appliance after each use.
- Be careful when you open the appliance door while the appliance is in operation. Hot air can release.
- Do not operate the appliance with wet hands or when it has contact with water.
- Do not apply pressure on the open door.
- Do not use the appliance as a work surface or as a storage surface.
- Open the appliance door carefully. The use of ingredients with alcohol can cause a mixture of alcohol and air.
- Do not let sparks or open flames to come in contact with the appliance when you open the door.
- Do not put flammable products or items that are wet with flammable products in, near or on the appliance.

WARNING!

Risk of damage to the appliance.

- To prevent damage or discoloration to the enamel:
 - do not put ovenware or other objects in the appliance directly on the bottom.
 - do not put aluminium foil directly on the bottom of cavity of the appliance.
 - do not put water directly into the hot appliance.
 - do not keep moist dishes and food in the appliance after you finish the cooking.
 - be careful when you remove or install the accessories.
- Discoloration of the enamel or stainless steel has no effect on the performance of the appliance.
- Use a deep pan for moist cakes. Fruit juices cause stains that can be permanent.

- Always cook with the appliance door closed.
- If the appliance is installed behind a furniture panel (e.g. a door) make sure the door is never closed when the appliance operates. Heat and moisture can build up behind a closed furniture panel and cause subsequent damage to the appliance, the housing unit or the floor. Do not close the furniture panel until the appliance has cooled down completely after use.

2.4 Care and cleaning

WARNING!

Risk of injury, fire, or damage to the appliance.

- Before maintenance, deactivate the appliance and disconnect the mains plug from the mains socket.
- Make sure the appliance is cold. There is the risk that the glass panels can break.
- Replace immediately the door glass panels when they are damaged. Contact the Authorised Service Centre.
- Be careful when you remove the door from the appliance. The door is heavy!
- Clean regularly the appliance to prevent the deterioration of the surface material.
- Clean the appliance with a moist soft cloth. Use only neutral detergents. Do not use abrasive products, abrasive cleaning pads, solvents or metal objects.
- If you use an oven spray, follow the safety instructions on its packaging.

2.5 Pyrolytic cleaning

WARNING!

Risk of Injury / Fires / Chemical Emissions (Fumes) in Pyrolytic Mode.

- Before carrying out the pyrolytic cleaning and initial preheating remove from the oven cavity:
 - any excess food residues, oil or grease spills / deposits.
 - any removable objects (including shelves, side rails, etc., provided with the appliance) especially any non-stick pots, pans, trays, utensils, etc.

- Read carefully all the instructions for pyrolytic cleaning.
- Keep children away from the appliance while the pyrolytic cleaning operates. The appliance becomes very hot and hot air is released from the front cooling vents.
- Pyrolytic cleaning is a high temperature operation that can release fumes from cooking residues and construction materials, as such consumers are advised to:
 - provide good ventilation during and after the pyrolytic cleaning.
 - provide good ventilation during and after the initial preheating.
- Do not spill or apply water on the oven door during and after the pyrolytic cleaning to avoid damaging the glass panels.
- Fumes released from all pyrolytic ovens / cooking residues as described are not harmful to humans, including children, or persons with medical conditions.
- Keep pets away from the appliance during and after the pyrolytic cleaning and initial preheating. Small pets (especially birds and reptiles) can be highly sensitive to temperature changes and emitted fumes.
- Non-stick surfaces on pots, pans, trays, utensils etc., can be damaged by the high temperature pyrolytic cleaning operation of all pyrolytic ovens and can be also a source for low level harmful fumes.

2.6 Internal lighting

WARNING!

Risk of electric shock.

- Concerning the lamp(s) inside this product and spare part lamps sold separately: These lamps are intended to withstand extreme physical conditions in household appliances, such as temperature, vibration, humidity, or are intended to signal information about the operational status of the appliance. They are not intended to be used in other applications and are not suitable for household room illumination.
- This product contains a light source of energy efficiency class G.
- Use only lamps with the same specifications.

2.7 Service

- To repair the appliance contact the Authorised Service Centre.
- Use original spare parts only.

2.8 Disposal

WARNING!

Risk of injury or suffocation.

- Contact your municipal authority for information on how to dispose of the appliance.
- Disconnect the appliance from the mains supply.
- Cut off the mains electrical cable close to the appliance and dispose of it.
- Remove the door catch to prevent children or pets from becoming trapped in the appliance.

3. PRODUCT DESCRIPTION

3.1 General overview

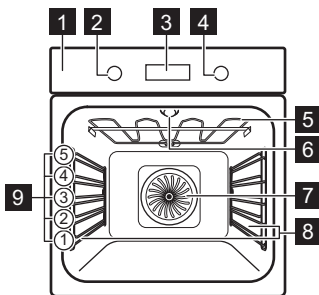

- 1** Control panel
- 2** Knob for the heating functions
- 3** Display
- 4** Control knob
- 5** Heating element
- 6** Lamp
- 7** Fan
- 8** Shelf support, removable
- 9** Shelf positions

3.2 Accessories

Wire shelf

For cookware, cake tins, roasts.

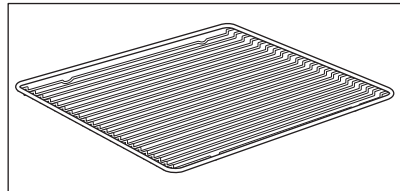

Baking tray

For cakes and biscuits.

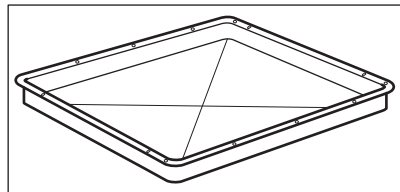

Grill- / Roasting pan

To bake and roast or as a pan to collect fat.

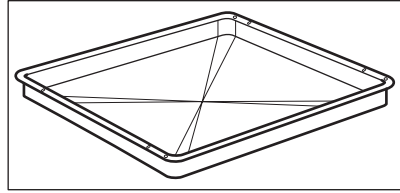

4. CONTROL PANEL

4.1 Retractable knobs

To use the appliance press the knob. The knob comes out.

4.2 Control panel overview

Select a heating function to turn on the appliance. Turn the knob for the heating

functions to the off position to turn the appliance off.

Timer	Fast Heat Up	Light	Lock	Confirm setting

4.3 Display

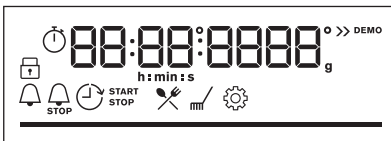

Display with key functions.

Display indicators

Basic indicators

Lock	Assisted Cooking	Cleaning	Settings	Fast Heat Up

Timer indicators

Minute minder	End time	Time Delay	Uptimer

Progress bar - for temperature or time. The bar is fully red when the appliance reaches the set temperature.



5. BEFORE FIRST USE

WARNING!

Refer to Safety chapters.

5.1 Initial cleaning

Before the first use, clean the empty appliance and set the time:



00:00

Set the time. Press **OK**.

5.2 Initial preheating

Preheat the empty oven before the first use.

Step 1 Remove all accessories and removable shelf supports from the oven.

Step 2 Set the maximum temperature for the function: 
Let the oven operate for 1 h.

Step 3 Set the maximum temperature for the function: 
Let the oven operate for 15 min.

 The oven can emit an odour and smoke during preheating. Make sure that the room is ventilated.

6. DAILY USE

WARNING!











Refer to Safety chapters.

6.1 How to set: Heating functions

Step 1 Turn the knob for the heating functions and select a heating function.

Step 2 Turn the control knob to set the temperature.

6.2 Heating functions

Heating function	Application
 True Fan Cooking	To bake on up to three shelf positions at the same time and to dry food. Set the temperature 20 - 40 °C lower than for Conventional Cooking.
 Conventional Cooking	To bake and roast food on one shelf position.
 Frozen Foods	To make convenience food crispy, e.g. french fries, potato wedges or spring rolls.
 Pizza Function	To bake pizza. To make intensive browning and a crispy bottom.
 Bottom Heat	To bake cakes with crispy bottom and to preserve food.
 Defrost	To defrost food (vegetables and fruit). The defrosting time depends on the amount and size of the frozen food.
 Moist Fan Baking	This function is designed to save energy during cooking. When you use this function, the temperature inside the appliance may differ from the set temperature. The residual heat is used. The heating power may be reduced. For more information refer to "Daily Use" chapter, Notes on: Moist Fan Baking.
 Grill	To grill thin pieces of food and to toast bread.
 Turbo Grilling	To roast large meat joints or poultry with bones on one shelf position. To make gratins and to brown.
 Menu	To enter the Menu: Assisted Cooking, Cleaning, Settings.

6.3 Notes on: Moist Fan Baking

This function was used to comply with the energy efficiency class and ecodesign requirements (according to EU 65/2014 and EU 66/2014). Tests according to: IEC/EN 60350-1.

The oven door should be closed during cooking so that the function is not interrupted

and the oven operates with the highest energy efficiency possible.





When you use this function the lamp automatically turns off after 30 sec.

For the cooking instructions refer to "Hints and tips" chapter, Moist Fan Baking. For general energy saving recommendations refer to "Energy Efficiency" chapter, Energy Saving.

6.4 How to set: Assisted Cooking



Every dish in this submenu has a recommended heating function and temperature. Use the function to prepare a dish quickly with default settings. You can also adjust the time and the temperature during cooking.







When the function ends check if the food is ready.





















For some of the dishes you can also cook with:		• Weight Automatic	
Step 1	Step 2	Step 3	Step 4
			
Enter the menu.	Select Assisted Cooking. Press OK .	Select the dish. Press OK .	Insert the dish to the oven. Confirm setting.





























6.5 Assisted Cooking

Legend	
	Weight Automatic available.

Legend	
	Preheat the appliance before you start cooking.
	Shelf level.





Dish	Weight	Shelf level / Accessory
P1 Roast Beef, rare		
P2 Roast Beef, medium	1 - 1.5 kg; 4 - 5 cm thick pieces	 2; baking tray Fry the meat for a few minutes on a hot pan. Insert to the appliance.
P3 Roast Beef, well done		
P4 Steak, medium	180 - 220 g per piece; 3 cm thick slices	  3; roasting dish on wire shelf Fry the meat for a few minutes on a hot pan. Insert to the appliance.
P5 Beef roast / braised (prime rib, top round, thick flank)	1.5 - 2 kg	  2; roasting dish on wire shelf Fry the meat for a few minutes on a hot pan. Add liquid. Insert to the appliance.
P6 Roast Beef, rare (slow cooking)		
P7 Roast Beef, medium (slow cooking)	1 - 1.5 kg; 4 - 5 cm thick pieces	 2; baking tray Use your favourite spices or simply salt and fresh ground pepper. Fry the meat for a few minutes on a hot pan. Insert to the appliance.
P8 Roast Beef, well done (slow cooking)		

	Dish	Weight	Shelf level / Accessory
P9	Fillet of beef, rare (slow cooking)		 2; baking tray
P10	Fillet of beef, medium (slow cooking)	0,5 - 1,5 kg; 5 - 6 cm thick pieces	Use your favourite spices or simply salt and fresh ground pepper. Fry the meat for a few minutes on a hot pan. Insert to the appliance.
P11	Fillet of beef, done (slow cooking)		
P12	Veal roast (e.g. shoulder)	0,8 - 1,5 kg; 4 cm thick pieces	  2; roasting dish on wire shelf Use your favourite spices. Add liquid. Roast covered.
P13	Pork roast neck or shoulder	1,5 - 2 kg	  2; roasting dish on wire shelf Turn the meat after half of the cooking time.
P14	Pulled pork (slow cooking)	1,5 - 2 kg	 2; baking tray Use your favourite spices. Turn the meat after half of the cooking time to get an even browning.
P15	Pork loin, fresh	1 - 1,5 kg; 5 - 6 cm thick pieces	 2; roasting dish on wire shelf Use your favourite spices.
P16	Pork spare ribs	2 - 3 kg; use raw, 2 - 3 cm thin spare ribs	 3; deep pan Add liquid to cover the bottom of a dish. Turn the meat after half of the cooking time.
P17	Lamb leg with bones	1,5 - 2 kg; 7 - 9 cm thick pieces	 2; roasting dish on baking tray Add liquid. Turn the meat after half of the cooking time.
P18	Whole chicken	1 - 1,5 kg; fresh	  2; casserole dish on baking tray Use your favourite spices. Turn the chicken after half of the cooking time to get an even browning.
P19	Half chicken	0,5 - 0,8 kg	 3; baking tray Use your favourite spices.
P20	Chicken breast	180 - 200 g per piece	  2; casserole dish on wire shelf Use your favourite spices. Fry the meat for a few minutes on a hot pan.
P21	Chicken legs, fresh	-	 3; baking tray If you marinated chicken legs first, set lower temperature and cook them longer.
P22	Duck, whole	2 - 3 kg	  2; roasting dish on wire shelf Use your favourite spices. Put the meat on roasting dish. Turn the duck after half of the cooking time.
P23	Goose, whole	4 - 5 kg	  2; deep pan Use your favourite spices. Put the meat on deep baking tray. Turn the goose after half of the cooking time.
P24	Meat loaf	1 kg	 2; wire shelf Use your favourite spices.









	Dish	Weight	Shelf level / Accessory
P25	Whole fish, grilled	0.5 - 1 kg per fish	 2; baking tray Fill the fish with butter and use your favourite spices and herbs.
P26	Fish fillet	-	  3; casserole dish on wire shelf Use your favourite spices.
P27	Cheesecake	-	 2;  28 cm springform tin on wire shelf
P28	Apple cake	-	 3; baking tray
P29	Apple tart	-	 2; pie form on wire shelf
P30	Apple pie	-	 1;  22 cm pie form on wire shelf
P31	Brownies	2 kg of dough	 3; deep pan
P32	Chocolate muffins	-	 3; muffin tray on wire shelf
P33	Loaf cake	-	 2; loaf pan on wire shelf
P34	Baked potatoes	1 kg	 2; baking tray Put the whole potatoes with skin on baking tray.
P35	Wedges	1 kg	 3; baking tray lined with baking paper Use your favourite spices. Cut potatoes into pieces.
P36	Grilled mixed vegetables	1 - 1.5 kg	 3; baking tray lined with baking paper Use your favourite spices. Cut the vegetables into pieces.
P37	Croquettes, frozen	0.5 kg	 3; baking tray
P38	Pommes, frozen	0.75 kg	 3; baking tray
P39	Meat / vegetable lasagna with dry pasta sheets	1 - 1.5 kg	 2; casserole dish on wire shelf
P40	Potato gratin (raw potatoes)	1 - 1.5 kg	 1; casserole dish on wire shelf Rotate the dish after half of the cooking time.
P41	Pizza fresh, thin	-	  2; baking tray lined with baking paper
P42	Pizza fresh, thick	-	  2; baking tray lined with baking paper
P43	Quiche	-	 2; baking tin on wire shelf
P44	Baguette / Ciabatta / White bread	0.8 kg	  2; baking tray lined with baking paper More time needed for white bread.
P45	Whole grain / Rye / Dark bread	1 kg	  2; baking tray lined with baking paper / loaf pan on wire shelf

7. CLOCK FUNCTIONS







7.1 Clock functions

Clock Function	Application
 Minute minder	When the timer ends, the signal sounds.
 Cooking time	When the timer ends, the signal sounds and the heating function stops.
 Time Delay	To postpone the start and / or end of cooking.
 Uptimer	Maximum is 23 h 59 min. This function has no effect on the operation of the oven. To turn on and off the Uptimer select: Menu, Settings.











7.2 How to set: Clock functions

How to set: Time of day		
Step 1	Step 2	Step 3
		
To change the time of day enter the menu and select Settings, Time of day.	Set the clock.	Press: OK .
How to set: Minute minder		
Step 1	Step 2	Step 3
		
Press:  .	Set the Minute minder	Press: OK .
 Timer starts counting down immediately.		

How to set: Cooking time

Step 1	Step 2		Step 3	Step 4
		The display shows: 0:00  STOP		
Choose a heating function and set the temperature.	Press repeatedly: 		Set the cooking time.	Press: OK.
 Timer starts counting down immediately.				

How to set: Time Delay

Step 1	Step 2	Step 3	Step 4	Step 5	Step 6		
		The display shows: the time of day  START			The display shows: --:--  STOP		
Select the heating function.	Press repeatedly: 	Set the start time.	Press: OK.	Set the end time.	Press: OK.		
 Timer starts counting down at a set start time.							

8. USING THE ACCESSORIES

WARNING!

Refer to Safety chapters.

8.1 Inserting accessories

A small indentation at the top increases safety. The indentations are also anti-tip

devices. The high rim around the shelf prevents cookware from slipping of the shelf.

Wire shelf:

Push the shelf between the guide bars of the shelf support.

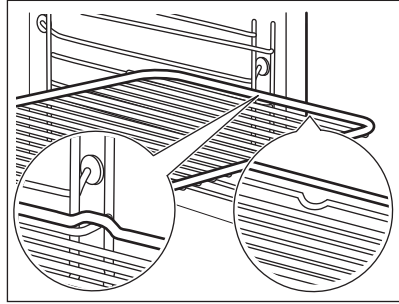

Baking tray / Deep pan:

Push the tray between the guide bars of the shelf support.

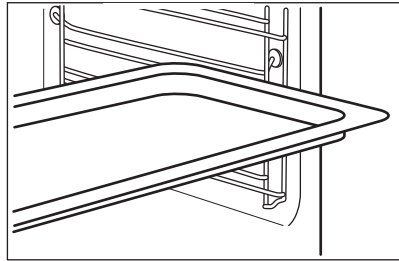

9. ADDITIONAL FUNCTIONS

9.1 Lock

This function prevents an accidental change of the appliance function.

Turn it on when the appliance works - the set cooking continues, the control panel is locked.
Turn it on when the appliance is off - it cannot be turned on, the control panel is locked.





 - press and hold to turn on the function.
A signal sounds.

 - press and hold to turn it off.

 3 x  - flashes when the lock is turned on.

9.2 Automatic switch-off

For safety reasons, if the heating function is active and no settings are changed, the appliance will turn off automatically after a certain period of time.

 (°C)	 (h)
30 - 115	12.5
120 - 195	8.5
200 - 245	5.5
250 - maximum	3

The Automatic switch-off does not work with the functions: Light, Time Delay.

9.3 Cooling fan

When the appliance operates, the cooling fan turns on automatically to keep the surfaces of

the appliance cool. If you turn off the appliance, the cooling fan can continue to operate until the appliance cools down.

10. HINTS AND TIPS

10.1 Cooking recommendations





The temperature and cooking times in the tables are guidelines only. They depend on the recipes and the quality and quantity of the ingredients used.

Your appliance may bake or roast differently to the appliance you had before. The hints below show recommended settings for temperature, cooking time and shelf position for specific types of the food.

If you cannot find the settings for a special recipe, look for the similar one.

10.2 Moist Fan Baking

For the best results follow suggestions listed in the table below.

	°C		
Pasta gratin	200 - 220	45 - 55	3
Potato gratin	180 - 200	70 - 85	3
Moussaka	170 - 190	70 - 95	3
Lasagne	180 - 200	75 - 90	3
Cannelloni	180 - 200	70 - 85	3
Bread pudding	190 - 200	55 - 70	3
Rice pudding	170 - 190	45 - 60	3
Apple cake, made of sponge cake mixture (round cake tin)	160 - 170	70 - 80	3
White bread	190 - 200	55 - 70	3

10.3 Moist Fan Baking - recommended accessories

Use the dark and non-reflective tins and containers. They have better heat absorption than the light colour and reflective dishes.



Pizza pan

Dark, non-reflective
28 cm diameter

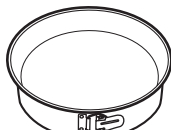

Baking dish

Dark, non-reflective
26 cm diameter



Ramekins

Ceramic
8 cm diameter, 5
cm height



Flan base tin





Dark, non-reflective
28 cm diameter

10.4 Cooking tables for test institutes

Information for test institutes





Tests according to: EN 60350, IEC 60350.

Baking on one level - baking in tins





		 °C	 min	
Fatless sponge cake	True Fan Cooking	160	45 - 60	2
Fatless sponge cake	Conventional Cooking	160	45 - 60	2
Apple pie, 2 tins Ø20 cm	True Fan Cooking	160	55 - 65	2
Apple pie, 2 tins Ø20 cm	Conventional Cooking	180	55 - 65	1
Short bread	True Fan Cooking	140	25 - 35	2
Short bread	Conventional Cooking	140	25 - 35	2

Baking on one level - biscuits

Use the third shelf position.

		 °C	 min
Small cakes, 20 per tray, preheat the empty oven	True Fan Cooking	150	20 - 30
Small cakes, 20 per tray, preheat the empty oven	Conventional Cooking	170	20 - 30





Multilevel baking - biscuits

		 °C	 min	
Short bread	True Fan Cooking	140	25 - 45	2 / 4
Small cakes, 20 per tray, pre-heat the empty oven	True Fan Cooking	150	25 - 35	1 / 4
Fatless sponge cake	True Fan Cooking	160	45 - 55	2 / 4
Apple pie, 1 tin per grid (Ø 20 cm)	True Fan Cooking	160	55 - 65	2 / 4

Grill

Preheat the empty oven for 5 minutes.

Grill with the maximum temperature setting.

		 min	
Toast	Grill	1 - 2	5
Beef steak, turn halfway through	Grill	24 - 30	4

11. CARE AND CLEANING

WARNING!

Refer to Safety chapters.

11.1 Notes on cleaning



Cleaning Agents

Clean the front of the appliance only with a microfibre cloth with warm water and a mild detergent.

Use a cleaning solution to clean metal surfaces.

Clean stains with a mild detergent.



Everyday Use

Clean the cavity after each use. Fat accumulation or other residue may cause fire.

Do not store the food in the appliance for longer than 20 minutes. Dry the cavity only with a microfibre cloth after each use.



Clean all accessories after each use and let them dry. Use only a microfibre cloth with warm water and a mild detergent. Do not clean the accessories in a dishwasher.

Do not clean the non-stick accessories using abrasive cleaner or sharp-edged objects.

Accessories

11.2 How to remove: Shelf supports

Remove the shelf supports to clean the oven.

Step 1 Turn off the oven and wait until it is cold.

Step 2 Pull the front of the shelf support away from the side wall.

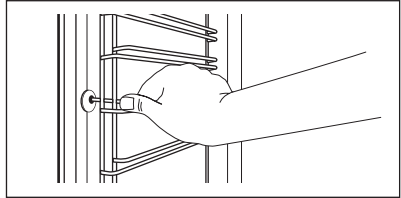

Step 3 Pull the rear end of the shelf support away from the side wall and remove it.

Step 4 Install the shelf supports in the opposite sequence.

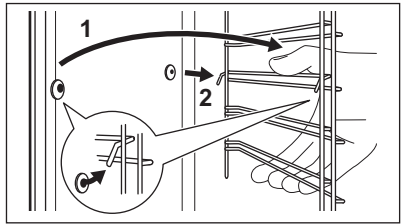

11.3 How to use: Pyrolytic Cleaning

Clean the oven with Pyrolytic Cleaning.

WARNING!

There is a risk of burns.

CAUTION!

If there are other appliances installed in the same cabinet, do not use them at the same time as this function. It can cause damage to the oven.

Before the Pyrolytic Cleaning:

Turn off the oven and wait until it is cold.

Remove all accessories and remove shelf supports.

Clean the oven floor and the inner door glass with warm water, a soft cloth and a mild detergent.

Pyrolytic Cleaning

Step 1

Enter menu: Cleaning /

Option

Duration

C1 - Light cleaning

1 h

Pyrolytic Cleaning

C2 - Normal cleaning 1 h 30 min

C3 - Thorough cleaning 3 h

Step 2 OK - press to select the cleaning programme.

Step 3 OK - press to start the cleaning.

Step 4 After cleaning, turn the knob for the heating functions to the off position.

i When the cleaning starts, the oven door is locked and the lamp is off. Until the door unlocks the display shows: .

When the cleaning ends:

Turn off the oven and wait until it is cold.

Clean the cavity with a soft cloth.

Remove the residue from the bottom of the cavity.

11.4 Cleaning Reminder

The oven reminds you when to clean it with pyrolytic cleaning.

 flashes in the display for 5 sec after each cooking session.

To turn off the reminder enter the Menu and select Settings, Cleaning Reminder.

11.5 How to remove and install: Door

You can remove the door and the internal glass panels to clean it. The number of glass panels is different for different models.

WARNING!

The door is heavy.

CAUTION!

Carefully handle the glass, especially around the edges of the front panel. The glass can break.

Step 1 Fully open the door.

Step 2 Lift and press the clamping levers (A) on the two door hinges.

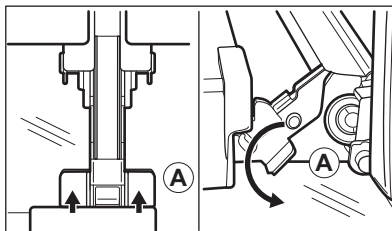

Step 3 Close the oven door to the first opening position (approximately 70° angle). Hold the door at both sides and pull it away from the oven at an upwards angle. Put the door with the outer side down on a soft cloth on a stable surface.

Step 4 Hold the door trim (B) on the top edge of the door at the two sides and push inwards to release the clip seal.

Step 5 Pull the door trim to the front to remove it.

Step 6 Hold the door glass panels on their top edge one by one and pull them up out of the guide.

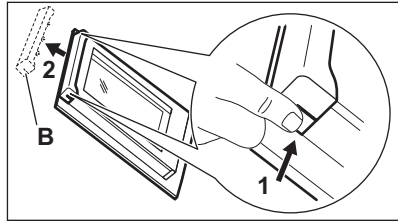

Step 7 Clean the glass panel with water and soap. Dry the glass panel carefully. Do not clean the glass panels in the dishwasher.

Step 8 After cleaning, do the above steps in the opposite sequence.

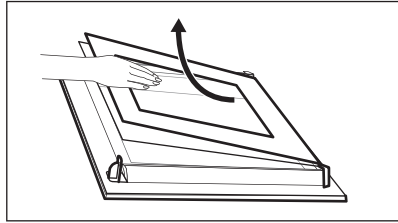

Step 9 Install the smaller panel first, then the larger and the door.

11.6 How to replace: Lamp

⚠ WARNING!
Risk of electric shock.
The lamp can be hot.

Before you replace the lamp:

Step 1	Step 2	Step 3
Turn off the oven. Wait until the oven is cold.	Disconnect the oven from the mains.	Put a cloth on the bottom of the cavity.

Top lamp

Step 1 Turn the glass cover to remove it.

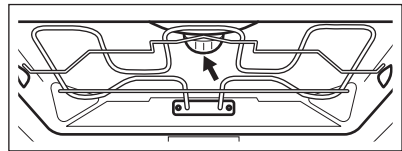

Step 2 Clean the glass cover.

Step 3 Replace the lamp with a suitable 300 °C heat-resistant lamp.

Step 4 Install the glass cover.

12. TROUBLESHOOTING

WARNING!

Refer to Safety chapters.

12.1 What to do if...

In any cases not included in this table please contact with an Authorised Service Centre.



The appliance does not turn on or does not heat up

Problem	Check if...
You cannot activate or operate the appliance.	The appliance is correctly connected to an electrical supply.
The appliance does not heat up.	The automatic switch-off is deactivated.
The appliance does not heat up.	The appliance door is closed.
The appliance does not heat up.	The fuse is not blown.
The appliance does not heat up.	The Lock is off.



Components

Problem	Check if...
The lamp is turned off.	Moist Fan Baking - is turned on.
The lamp does not work.	The lamp is burnt out.



Error codes

The display shows...	Check if...
Err C3	The appliance door is closed or the door lock is not broken.
Err F102	The appliance door is closed.
Err F102	The door lock is not broken.
00:00	There was a power cut. Set the time of day.

If the display shows an error code that is not in this table turn the house fuse off and on to restart the appliance. If the error code recurs contact an Authorised Service Centre.

12.2 Service data

If you cannot find a solution to the problem yourself, contact your dealer or an Authorised Service Centre.

The necessary data for the service centre is on the rating plate. The rating plate is on the front frame of the appliance cavity. Do not remove the rating plate from the appliance cavity.

We recommend that you write the data here:

Model (MOD.)

Product number (PNC)

We recommend that you write the data here:

Serial number (S.N.)

13. ENERGY EFFICIENCY

13.1 Product Information and Product Information Sheet according to EU Ecodesign and Energy Labelling Regulations

Supplier's name	AEG	
Model identification	BPK535060B 944188596 BPK535060M 944188597	
Energy Efficiency Index	81.2	
Energy efficiency class	A+	
Energy consumption with a standard load, conventional mode	1.09 kWh/cycle	
Energy consumption with a standard load, fan-forced mode	0.69 kWh/cycle	
Number of cavities	1	
Heat source	Electricity	
Volume	71 l	
Type of oven	Built-In Oven	
Mass	BPK535060B	35.0 kg
	BPK535060M	35.0 kg

IEC/EN 60350-1 - Household electric cooking appliances - Part 1: Ranges, ovens, steam ovens and grills - Methods for measuring performance.

13.2 Energy saving



The appliance has features which help you save energy during everyday cooking.

Make sure that the appliance door is closed when the appliance operates. Do not open the appliance door too often during cooking. Keep the door gasket clean and make sure it is well fixed in its position.

Use metal cookware to improve energy saving.

When possible, do not preheat the appliance before cooking.

Keep breaks between baking as short as possible when you prepare a few dishes at one time.

Cooking with fan

When possible, use the cooking functions with fan to save energy.

Residual heat

The fan and lamp continue to operate. When you turn off the appliance, the display shows the residual heat. You can use that heat to keep the food warm.

When the cooking duration is longer than 30 min, reduce the appliance temperature to minimum 3 - 10 min before the end of cooking. The residual heat inside the appliance will continue to cook.

Use the residual heat to warm up other dishes.

Keep food warm

Choose the lowest possible temperature setting to use residual heat and keep a meal warm. The residual heat indicator or temperature appears on the display.

Cooking with the lamp off

Turn off the lamp during cooking. Turn it on only when you need it.







Moist Fan Baking

Function designed to save energy during cooking.

When you use this function the lamp automatically turns off after 30 sec. You may turn on the lamp again but this action will reduce the expected energy savings.

14. MENU STRUCTURE

14.1 Menu

Step 1	Step 2	Step 3	Step 4	Step 5
				
 - select to enter the Menu.	Select the option from Menu structure and press OK .	Select the setting.	OK - press to confirm setting.	Adjust the value and press OK .

Turn the knob for the heating functions to the off position to exit the Menu.

Menu structure

Assisted Cooking 

Cleaning 

Settings 

Settings

01	Time of day	Change	02	Display brightness	1 - 5
03	Key tones	1 - Beep 2 - Click 3 - Sound off	04	Buzzer volume	1 - 4
05	Uptimer	On / Off	06	Light	On / Off
07	Fast Heat Up	On / Off	08	Cleaning Reminder	On / Off
09	Demo mode	Activation code: 2468	10	Software version	Check
11	Reset all settings	Yes / No			

15. ENVIRONMENTAL CONCERNS

Recycle materials with the symbol . Put the packaging in relevant containers to recycle it. Help protect the environment and human health by recycling waste of electrical and electronic appliances. Do not dispose of

appliances marked with the symbol  with the household waste. Return the product to your local recycling facility or contact your municipal office.

Bienvenue chez AEG ! Nous vous remercions d'avoir choisi l'un de nos appareils.



Obtenir des conseils d'utilisation, des brochures, un dépanneur, des informations sur le service et les réparations sur aeg.com/support



Pour plus de recettes, conseils, informations de dépannage, téléchargez l'application **My AEG Kitchen**.



Sous réserve de modifications.

TABLE DES MATIÈRES

1. INFORMATION SUR LA SÉCURITÉ.....	78
2. CONSIGNES DE SÉCURITÉ.....	80
3. DESCRIPTION DE L'APPAREIL.....	84
4. BANDEAU DE COMMANDE.....	85
5. AVANT LA PREMIÈRE UTILISATION.....	85
6. UTILISATION QUOTIDIENNE.....	86
7. FONCTIONS DE L'HORLOGE.....	91
8. UTILISATION DES ACCESSOIRES.....	93
9. FONCTIONS SUPPLÉMENTAIRES.....	93
10. CONSEILS.....	94
11. ENTRETIEN ET NETTOYAGE.....	97
12. DÉPANNAGE.....	100
13. RENDEMENT ÉNERGÉTIQUE.....	101
14. STRUCTURE DES MENUS.....	103
15. EN MATIÈRE DE PROTECTION DE L'ENVIRONNEMENT.....	103

1. ⚠ INFORMATION SUR LA SÉCURITÉ

Avant d'installer et d'utiliser cet appareil, lisez soigneusement les instructions fournies. Le fabricant ne pourra être tenu pour responsable des blessures et dégâts résultant d'une mauvaise installation ou utilisation. Conservez toujours les instructions dans un lieu sûr et accessible pour vous y référer ultérieurement.

1.1 Sécurité des enfants et des personnes vulnérables

- Cet appareil peut être utilisé par des enfants âgés d'au moins 8 ans et par des personnes ayant des capacités

physiques, sensorielles ou mentales réduites ou dénuées d'expérience ou de connaissance, s'ils sont correctement surveillés ou si des instructions relatives à l'utilisation de l'appareil en toute sécurité leur ont été données et s'ils comprennent les risques encourus. Les enfants de moins de 8 ans et les personnes ayant un handicap très important et complexe doivent être tenus à l'écart de l'appareil, à moins d'être surveillés en permanence.

- Veillez à ce que les enfants ne jouent pas avec l'appareil.
- Ne laissez pas les emballages à la portée des enfants et jetez-les convenablement.
- **AVERTISSEMENT** : L'appareil et ses parties accessibles deviennent chauds pendant l'utilisation. Tenez les enfants et les animaux éloignés de l'appareil lorsqu'il est en cours d'utilisation et de refroidissement.
- Si l'appareil est équipé d'un dispositif de sécurité enfants, nous vous recommandons de l'activer.
- Le nettoyage et l'entretien par l'utilisateur ne doivent pas être effectués par des enfants sans surveillance.

1.2 Sécurité générale

- Cet appareil est exclusivement destiné à un usage culinaire.
- Cet appareil est conçu pour un usage domestique unique, dans un environnement intérieur.
- Cet appareil peut être utilisé dans les bureaux, les chambres d'hôtel, les chambres d'hôtes, les maisons d'hôtes de ferme et d'autres hébergements similaires lorsque cette utilisation ne dépasse pas le niveau (moyen) de l'utilisation domestique.
- Cet appareil doit être installé et le câble remplacé uniquement par un professionnel qualifié.
- N'utilisez pas l'appareil avant de l'avoir installé dans la structure encastrée.
- Débranchez l'appareil de l'alimentation électrique avant toute opération d'entretien.

- Si le cordon d'alimentation est endommagé, il doit être remplacé par le fabricant, son service après-vente agréé ou toute personne disposant de qualifications similaires afin d'éviter tout danger électrique.
- **AVERTISSEMENT** : Assurez-vous que l'appareil est éteint avant de remplacer l'ampoule pour éviter tout risque d'électrocution.
- **AVERTISSEMENT** : L'appareil et ses parties accessibles deviennent chauds pendant l'utilisation. Des précautions doivent être prises pour éviter de toucher les éléments chauffants ou la surface de la cavité de l'appareil.
- Utilisez toujours des gants de cuisine pour retirer ou insérer des accessoires ou des plats allant au four.
- Pour retirer les supports de grille, tirez d'abord l'avant du support de grille, puis l'arrière à distance des parois latérales. Installez les supports de grille dans l'ordre inverse.
- N'utilisez pas de nettoyeur à vapeur pour nettoyer l'appareil.
- N'utilisez pas de produits abrasifs ni de racloirs pointus en métal pour nettoyer la porte en verre car ils peuvent rayer la surface, ce qui peut briser le verre.
- Avant le nettoyage par pyrolyse, retirez tous les accessoires et les dépôts/déversements excessifs de la cavité de l'appareil.

2. CONSIGNES DE SÉCURITÉ

2.1 Installation

AVERTISSEMENT!

L'appareil doit être installé uniquement par un professionnel qualifié.

- Retirez l'intégralité de l'emballage.
- N'installez pas et ne branchez pas un appareil endommagé.
- Suivez scrupuleusement les instructions d'installation fournies avec l'appareil.
- Soyez toujours vigilants lorsque vous déplacez l'appareil car il est lourd. Utilisez toujours des gants de sécurité et des chaussures fermées.
- Ne tirez jamais l'appareil par la poignée.
- Installez l'appareil dans un lieu sûr et adapté répondant aux exigences d'installation.
- Respectez l'espacement minimal requis par rapport aux autres appareils et éléments.
- Avant de monter l'appareil, vérifiez si la porte de l'appareil s'ouvre sans retenue.
- L'appareil est équipé d'un système de refroidissement électrique. Il doit être utilisé avec l'alimentation électrique.

- L'unité intégrée doit répondre aux exigences de stabilité de la norme DIN 68930.

Hauteur minimale du meuble (Hauteur minimale du meuble sous le plan de travail)	578 (600) mm
Largeur du meuble	560 mm
Profondeur du meuble	550 (550) mm
Hauteur de l'avant de l'appareil	594 mm
Hauteur de l'arrière de l'appareil	576 mm
Largeur de l'avant de l'appareil	595 mm
Largeur de l'arrière de l'appareil	559 mm
Profondeur de l'appareil	567 mm
Profondeur d'encastrement de l'appareil	546 mm
Profondeur avec porte ouverte	1027 mm
Dimensions minimales de l'ouverture de ventilation. Ouverture placée sur la partie inférieure de la face arrière	560x20 mm
Longueur du câble d'alimentation secteur. Le câble est placé dans le coin droit de la face arrière	1500 mm
Vis de montage	4x25 mm

2.2 Branchement électrique



AVERTISSEMENT!

Risque d'incendie ou d'électrocution.

- Tous les raccordements électriques doivent être effectués par un électricien qualifié.
- L'appareil doit être relié à la terre.
- Assurez-vous que les paramètres figurant sur la plaque signalétique correspondent aux données électriques nominale de l'alimentation secteur.
- Utilisez toujours une prise de courant de sécurité correctement installée.

- N'utilisez pas d'adaptateurs multiprise et de rallonges.
- Veillez à ne pas endommager la fiche secteur ni le câble d'alimentation. Le remplacement du câble d'alimentation de l'appareil doit être effectué par notre service après-vente agréé.
- Ne laissez pas les câbles d'alimentation entrer en contact ou s'approcher de la porte de l'appareil ou de la niche d'encastrement sous l'appareil, particulièrement lorsqu'il est en marche ou que la porte est chaude.
- La protection contre les chocs des parties sous tension et isolées doit être fixée de telle manière qu'elle ne puisse pas être enlevée sans outils.
- Ne branchez la fiche secteur dans la prise secteur qu'à la fin de l'installation. Assurez-vous que la prise secteur est accessible après l'installation.
- Si la prise secteur est détachée, ne branchez pas la fiche secteur.
- Ne tirez pas sur le câble secteur pour débrancher l'appareil. Tirez toujours sur la fiche de la prise secteur.
- N'utilisez que des systèmes d'isolation appropriés : des coupe-circuits, des fusibles (les fusibles à visser doivent être retirés du support), un disjoncteur différentiel et des contacteurs.
- L'installation électrique doit comporter un dispositif d'isolation qui vous permet de déconnecter l'appareil du secteur à tous les pôles. Le dispositif d'isolement doit avoir une largeur d'ouverture de contact de 3 mm minimum.
- Fermez bien la porte de l'appareil avant de brancher la fiche à la prise secteur.
- Cet appareil est fourni avec une fiche électrique et un câble d'alimentation.

2.3 Utilisation



AVERTISSEMENT!

Risque de blessures, de brûlures, d'électrocution ou d'explosion.

- Ne modifiez pas les spécifications de cet appareil.
- Assurez-vous que les orifices d'aération ne sont pas obstrués.

- Ne laissez pas l'appareil sans surveillance durant son fonctionnement.
- Éteignez l'appareil après chaque utilisation.
- Soyez prudent lors de l'ouverture de la porte de l'appareil lorsque celui-ci fonctionne. De l'air chaud peut se dégager.
- N'utilisez pas l'appareil avec des mains mouillées ou en contact avec de l'eau.
- N'exercez pas de pression sur la porte ouverte.
- N'utilisez pas l'appareil comme plan de travail ou comme espace de rangement.
- Ouvrez la porte de l'appareil avec précaution. L'utilisation d'ingrédients avec de l'alcool peut provoquer un mélange d'alcool et d'air.
- Ne laissez pas des étincelles ou des flammes nues entrer en contact avec l'appareil lorsque vous ouvrez la porte.
- Ne placez pas de produits inflammables ou d'éléments imbibés de produits inflammables à l'intérieur, à proximité ou au-dessus de l'appareil.

⚠ AVERTISSEMENT!

Risque de dommages à l'appareil.

- Pour éviter tout endommagement ou décoloration de l'émail :
 - ne posez pas de plats allant au four ou d'autres objets directement dans le fond de l'appareil.
 - ne placez jamais de feuilles d'aluminium directement sur le fond de la cavité de l'appareil.
 - ne versez pas d'eau directement dans l'appareil chaud.
 - ne conservez pas de plats et de nourriture humides dans l'appareil après avoir terminé la cuisson.
 - Installez ou retirez les accessoires avec précautions.
- La décoloration de l'émail ou de l'acier inoxydable est sans effet sur les performances de l'appareil.
- Utilisez un plat à rôtir pour des gâteaux moelleux. Les jus de fruits provoquent des taches qui peuvent être permanentes.
- Cuisinez toujours avec la porte de l'appareil fermée.
- Si l'appareil est installé derrière la paroi d'un meuble (par ex. une porte), veuillez à

ce que la porte ne soit jamais fermée lorsque l'appareil fonctionne. La chaleur et l'humidité peuvent s'accumuler derrière la porte fermée du meuble et provoquer d'importants dégâts sur l'appareil, votre logement ou le sol. Ne fermez pas la paroi du meuble tant que l'appareil n'a pas refroidi complètement.

2.4 Entretien et Nettoyage

⚠ AVERTISSEMENT!

Risque de blessure, d'incendie ou de dommages à l'appareil.

- Avant toute opération d'entretien, désactivez l'appareil et débranchez la fiche secteur.
- Vérifiez que l'appareil est froid. Les panneaux de verre risquent de se briser.
- Remplacez immédiatement les vitres de la porte si elles sont endommagées. Contactez le service après-vente agréé.
- Soyez prudent lorsque vous retirez la porte de l'appareil. La porte est lourde !
- Nettoyez régulièrement l'appareil afin de maintenir le revêtement en bon état.
- Nettoyez l'appareil avec un chiffon doux et humide. Utilisez uniquement des produits de lavage neutres. N'utilisez pas de produits abrasifs, de tampons à récurer, de solvants ou d'objets métalliques.
- Si vous utilisez un spray pour four, suivez les consignes de sécurité figurant sur son emballage.

2.5 Nettoyage par pyrolyse

⚠ AVERTISSEMENT!

Risque de blessures, d'incendie, d'émissions chimiques (fumées) en mode pyrolyse.

- Avant d'effectuer un nettoyage par pyrolyse et un préchauffage initial, retirez de la cavité du four :
 - tout résidu alimentaire excessif, déversement et dépôt d'huile ou de graisse.
 - tous les objets amovibles (y compris les grilles, les rails latéraux, etc., fournis avec l'appareil), en particulier

les casseroles, poêles, plateaux, ustensiles anti-adhésifs, etc.

- Lisez attentivement toutes les instructions relatives au nettoyage par pyrolyse.
- Tenez les jeunes enfants éloignés de l'appareil lorsque le nettoyage par pyrolyse est en cours. L'appareil devient très chaud et de l'air chaud est libéré des orifices d'aération avant.
- Le nettoyage par pyrolyse est un fonctionnement à haute température qui peut dégager de la fumée provenant des résidus de cuisson et des matériaux de construction. Par conséquent, il est recommandé aux consommateurs de :
 - veillez à assurer une bonne ventilation pendant et après le nettoyage par pyrolyse.
 - veillez à assurer une bonne ventilation pendant et après le préchauffage initial.
- Ne renversez pas ou n'appliquez pas d'eau sur la porte du four pendant et après le nettoyage par pyrolyse pour éviter d'endommager les panneaux de verre.
- Les fumées dégagées par les fours à pyrolyse / les résidus de cuisson sont décrites comme étant non nocives pour les êtres humains, y compris pour les jeunes ou les personnes à la santé fragile.
- Maintenez les animaux domestiques à l'écart de l'appareil pendant et après le nettoyage par pyrolyse et le préchauffage initial. Les petits animaux de compagnie (en particulier les oiseaux et les reptiles) peuvent être très sensibles aux changements de température et aux fumées émises.
- Les surfaces anti-adhésives des casseroles, des poêles, des plaques, des ustensiles, etc. peuvent être endommagées par le nettoyage par pyrolyse à haute température et peuvent également être source de fumées légèrement nocives.

2.6 Éclairage interne



AVERTISSEMENT!

Risque d'électrocution.

- Concernant la/les lampe(s) à l'intérieur de ce produit et les lampes de rechange vendues séparément : Ces lampes sont conçues pour résister à des conditions physiques extrêmes dans les appareils électroménagers, telles que la température, les vibrations, l'humidité, ou sont conçues pour signaler des informations sur le statut opérationnel de l'appareil. Elles ne sont pas destinées à être utilisées dans d'autres applications et ne conviennent pas à l'éclairage des pièces d'un logement.
- Ce produit contient une source lumineuse de classe d'efficacité énergétique G.
- Utilisez uniquement des ampoules ayant les mêmes spécifications.

2.7 Service

- Pour réparer l'appareil, contactez le service après-vente agréé.
- Utilisez uniquement des pièces de rechange d'origine.

2.8 Mise au rebut



AVERTISSEMENT!

Risque de blessure ou d'asphyxie.

- Contactez votre service municipal pour obtenir des informations sur la marche à suivre pour mettre l'appareil au rebut.
- Débranchez l'appareil de l'alimentation électrique.
- Coupez le câble d'alimentation au ras de l'appareil et mettez-le au rebut.
- Retirez le dispositif de verrouillage du hublot pour empêcher les jeunes et les animaux de s'enfermer dans l'appareil.

3. DESCRIPTION DE L'APPAREIL

3.1 Vue d'ensemble

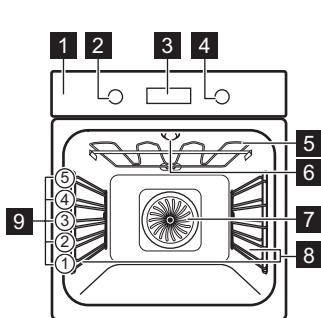

- 1 Bandeau de commande
- 2 Manette de sélection des modes de cuisson
- 3 Affichage
- 4 Manette de commande
- 5 Résistance
- 6 Éclairage
- 7 Chaleur tournante
- 8 Support de grille, amovible
- 9 Niveaux de la grille

3.2 Accessoires

Grille métallique

Pour les plats de cuisson, les moules à gâteaux, les rôtis.

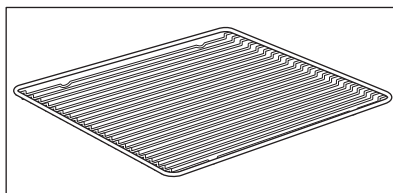

Plateau de cuisson

Pour les gâteaux et biscuits.

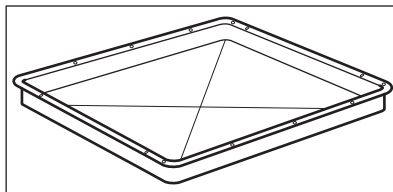

Plat à rôtir

Pour cuire et rôtir ou comme plat pour récupérer la graisse.

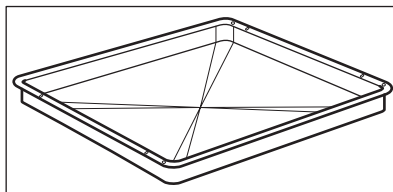

4. BANDEAU DE COMMANDE





4.1 Manettes rétractables

Pour utiliser l'appareil, appuyez sur la manette. La manette sort alors de son logement.

4.2 Vue d'ensemble du bandeau de commande

Sélectionnez un mode de cuisson pour mettre en fonctionnement l'appareil. Tournez

la manette des modes de cuisson sur la position Arrêt pour éteindre l'appareil.

				
Minuteur	Préchauffage rapide	Eclairage four	Verrouillage	Confirmez la configuration

4.3 Affichage

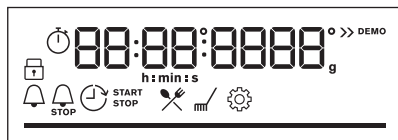

Affichage avec les principales fonctions.

Voyants de l'affichage

Indicateurs de base

 Touches Verrouil	 Cuisson assistée	 Nettoyage	 Configurations	 Préchauffage rapide
---	---	--	---	--

Voyants du minuteur

 Minuteur	 Fin de cuisson	 Départ différé	 Compteur
---	---	---	---

Barre de progression - de la température ou de l'heure. La barre est entièrement rouge lorsque l'appareil atteint la température réglée.

5. AVANT LA PREMIÈRE UTILISATION

AVERTISSEMENT!

Reportez-vous aux chapitres concernant la sécurité.

5.1 Nettoyage initial

Avant la première utilisation, nettoyez l'appareil à vide et réglez la durée :



00:00

Réglez l'heure. Appuyez sur la touche **OK**.

5.2 Préchauffage initial

Préchauffez le four à vide avant de l'utiliser pour la première fois.

Étape 1 Retirez du four les accessoires et les supports de grille amovibles.

Étape 2 Réglez la température maximale pour la fonction : .
Laissez le four fonctionner pendant 1 h.

Étape 3 Réglez la température maximale pour la fonction : .
Laissez le four fonctionner pendant 15 min.

 Une odeur et de la fumée peuvent s'échapper du four durant le préchauffage. Assurez-vous que la pièce est ventilée.

6. UTILISATION QUOTIDIENNE

AVERTISSEMENT!

Reportez-vous aux chapitres concernant la sécurité.

6.1 Comment régler les Modes de cuisson

Étape 1 Tournez la manette des modes de cuisson et sélectionnez un mode de cuisson.

Étape 2 Tournez le bouton de commande pour régler la température.

6.2 Modes de cuisson









Mode de cuisson

Application



Chaleur tournante

Pour faire cuire sur trois niveaux en même temps et pour déshydrater des aliments. Diminuez les températures de 20 à 40 °C par rapport à la Chauffage Haut/Bas.

Mode de cuisson	Application
 Chauffage Haut/Bas	Pour cuire et rôtir des aliments sur un seul niveau.
 Plats Surgelés	Pour rendre croustillants vos plats préparés, tels que frites, pommes quartiers et nems.
 Fonction Pizza	Pour cuire des pizzas. Pour faire dorer de façon intensive et obtenir un dessous croustillant.
 Cuisson de sole	Pour cuire des gâteaux avec dessous croustillant et pour stériliser des aliments.
 Décongélation	Pour décongeler des aliments (fruits et légumes). Le temps de décongélation dépend de la quantité et de la grosseur des plats surgelés.
 Chaleur Tournante Humide	Cette fonction est conçue pour économiser de l'énergie pendant la cuisson. Lorsque vous utilisez cette fonction, la température à l'intérieur de l'appareil peut différer de la température réglée. La chaleur résiduelle est utilisée. La puissance de chauffage peut être réduite. Pour plus d'informations, reportez-vous au chapitre « Utilisation quotidienne », Remarques concernant : Chaleur Tournante Humide.
 Gril	Pour faire griller des aliments peu épais et du pain.
 Turbo gril	Pour rôtir de gros morceaux de viande ou de volaille avec os sur un seul niveau. Pour gratiner et faire dorer.
 Menu	Pour accéder au menu : Cuisson assistée, Nettoyage, Configurations.

6.3 Remarques sur : Chaleur Tournante Humide

Cette fonction était utilisée pour se conformer à la classe d'efficacité énergétique et aux exigences Ecodesign (selon les normes EU 65/2014 et EU 66/2014). Tests conformes à la norme : IEC/EN 60350-1.

La porte du four doit être fermée pendant la cuisson pour que la fonction ne soit pas interrompue et que le four fonctionne avec la plus grande efficacité énergétique possible.

Lorsque vous utilisez cette fonction, l'éclairage s'éteint automatiquement au bout de 30 secondes.

Pour consulter les instructions de cuisson, reportez-vous au chapitre « Conseils », Chaleur Tournante Humide. Pour obtenir des recommandations générales sur l'économie d'énergie, reportez-vous au chapitre « Efficacité énergétique », « Économie d'énergie ».







6.4 Comment régler : Cuisson assistée

Chaque plat apparaissant dans ce sous-menu a un mode de cuisson et une température recommandés. Vous pouvez utiliser la fonction pour préparer un plat rapidement avec les réglages par défaut. Vous pouvez également régler la durée et la température pendant la cuisson.

Lorsque la fonction se termine, vérifiez si les aliments sont prêts.



Pour certains plats, vous pouvez également réaliser la cuisson avec :





- Poids automatique















Étape 1	Étape 2	Étape 3	Étape 4
			
		P1 - P...	OK
Accédez au menu.	Sélectionnez Cuisson assistée. Appuyez sur OK .	Sélectionnez le plat. Appuyez sur la touche OK .	Placez le plat dans le four. Confirmez la configuration.























6.5 Cuisson assistée













Légende	
	Poids automatique disponible.

Légende	
	Préchauffez l'appareil avant de commencer la cuisson.
	Niveau de grille.

	Plat	Poids	Niveau/Accessoire
P1	Rôti de bœuf, saignant		
P2	Rôti de bœuf, à point	1 - 1.5 kg ; 4 à 5 cm d'épaisseur	 2 ; plateau de cuisson
P3	Rôti de bœuf, bien cuit		Faire frire la viande pendant quelques minutes sur une poêle chaude. Insérez-le dans l'appareil.
P4	Steak de bœuf, à point	180 - 220 g par pièce ; 3 cm d'épaisseur	  3 ; plat à rôtir sur grille métallique
P5	Bœuf rôti/braisé (côte de bœuf, intérieur de ronde, flanchet)	1.5 - 2 kg	  2 ; plat à rôtir sur grille métallique
			Faire frire la viande pendant quelques minutes sur une poêle chaude. Ajoutez du liquide. Insérez-le dans l'appareil.





	Plat	Poids	Niveau/Accessoire
P6	Rôti de bœuf, saignant (cuisson basse température)		 2 ; plateau de cuisson
P7	Rôti de bœuf, à point (cuisson basse température)	1 - 1.5 kg ; 4 à 5 cm d'épaisseur	Servez-vous de vos épices préférées ou simplement du sel et du poivre fraîchement moulu. Faire frire la viande pendant quelques minutes sur une poêle chaude. Insérez-le dans l'appareil.
P8	Rôti de bœuf, bien cuit (cuisson basse température)		
P9	Filet de bœuf rare (cuisson lente)		 2 ; plateau de cuisson
P10	Filet de bœuf, moyen (cuisson lente)	0,5 à 1,5 kg ; 5 à 6 cm d'épaisseur	Servez-vous de vos épices préférées ou simplement du sel et du poivre fraîchement moulu. Faire frire la viande pendant quelques minutes sur une poêle chaude. Insérez-le dans l'appareil.
P11	Filet de bœuf, cuit (cuisson lente)		
P12	Rôti de veau (par ex. épaule)	0.8 - 1.5 kg ; 4 cm d'épaisseur	  2 ; plat à rôtir sur grille métallique Utilisez vos épices préférées. Ajoutez du liquide. Rôti couvert.
P13	Rôti de porc - collet ou épaule	1.5 - 2 kg	  2 ; plat à rôtir sur grille métallique Retournez la viande à la moitié du temps de cuisson.
P14	Émincé de porc (cuisson lente)	1.5 - 2 kg	 2 ; plateau de cuisson Utilisez vos épices préférées. Retournez la viande à la moitié du temps de cuisson pour faire dorer de manière homogène.
P15	Filet de porc frais	1 - 1.5 kg ; 5 à 6 cm d'épaisseur	 2 ; plat à rôtir sur grille métallique Utilisez vos épices préférées.
P16	Travers de porc	2 - 3 kg ; côtes levées crues, 2 à 3 cm d'épaisseur	 3 plat profond Ajoutez du liquide pour recouvrir le fond d'un plat. Retournez la viande à la moitié du temps de cuisson.
P17	Gigot d'agneau avec os	1.5 - 2 kg ; 7 à 9 cm d'épaisseur	 2 ; plat à rôtir sur plateau de cuisson Ajoutez du liquide. Retournez la viande à la moitié du temps de cuisson.
P18	Poulet entier	1 - 1.5 kg ; frais	  2 ; cocotte sur plateau de cuisson Utilisez vos épices préférées. Retournez le poulet à la moitié du temps de cuisson pour faire dorer de manière homogène.
P19	Demi poulet	0.5 - 0.8 kg	 3 ; plateau de cuisson Utilisez vos épices préférées.
P20	Escalope de poulet	180 - 200 g par pièce	  2 ; cocotte sur grille métallique Utilisez vos épices préférées. Faire frire la viande pendant quelques minutes sur une poêle chaude.

	Plat	Poids	Niveau/Accessoire
P21	Cuisses de poulet, fraîches	-	 3 ; plateau de cuisson Si vous avez mariné les cuisses de poulet, réglez une température inférieure et faites-les cuire plus longtemps.
P22	Canard entier	2 - 3 kg	  2 ; plat à rôtir sur grille métallique Utilisez vos épices préférées. Placez la viande sur un plat à rôtir. Retournez le canard à la moitié du temps de cuisson.
P23	Oie entière	4 - 5 kg	  2; poêle profonde Utilisez vos épices préférées. Placez la viande sur un plateau de cuisson profond. Retournez l'oie à la moitié du temps de cuisson.
P24	Rôti haché	1 kg	 2 ; grille métallique Utilisez vos épices préférées.
P25	Poisson entier, grillé	0.5 - 1 kg par poisson	 2 ; plateau de cuisson Remplissez le poisson avec du beurre et utilisez vos épices et herbes préférées.
P26	Filet de poisson	-	  3 ; cocotte sur grille métallique Utilisez vos épices préférées.
P27	Cheesecake	-	 2 ;  28 cm moule à charnière sur grille métallique
P28	Gâteau aux pommes	-	 3 ; plateau de cuisson
P29	Tarte aux pommes	-	 2 ; moule à tarte sur grille métallique
P30	Tarte aux pommes	-	 1 ;  22 cm moule à tarte sur grille métallique
P31	Brownies	2 kg de pâte	 3 ; plat profond
P32	Muffins au chocolat	-	 3 ; bac à muffins sur grille métallique
P33	Quatre-quarts	-	 2 ; moule quatre-quarts sur grille métallique
P34	Pommes de terre au four	1 kg	 2 ; plateau de cuisson Placez les pommes de terre entières avec la peau sur un plateau de cuisson.
P35	Pommes quartiers	1 kg	 3 ; plateau de cuisson recouvert de papier sulfurisé Utilisez vos épices préférées. Coupez les pommes de terre en morceaux.
P36	Mélange de légumes grillés	1 - 1.5 kg	 3 ; plateau de cuisson recouvert de papier sulfurisé Utilisez vos épices préférées. Coupez les légumes en morceaux.
P37	Croquettes surgelées	0.5 kg	 3 ; plateau de cuisson

	Plat	Poids	Niveau/Accessoire
P38	Pommes, surgelées	0.75 kg	 3 ; plateau de cuisson
P39	Lasagnes à la viande/aux légumes avec feuilles de pâtes sèches	1 - 1.5 kg	 2 ; cocotte sur grille métallique
P40	Gratin de pommes de terre (pommes de terre crues)	1 - 1.5 kg	 1 ; cocotte sur grille métallique Tournez le plat après la moitié du temps de cuisson.
P41	Pizza fraîche, fine	-	  2 ; plateau de cuisson recouvert de papier sulfurisé
P42	Pizza fraîche, épaisse	-	  2 ; plateau de cuisson recouvert de papier sulfurisé
P43	Quiche	-	 2 ; plat de cuisson sur grille métallique
P44	Baguette/Ciabatta/ Pain blanc	0.8 kg	  2 ; plateau de cuisson recouvert de papier sulfurisé Prolonger le temps pour le pain blanc.
P45	Céréales complètes / Riz / Pain noir	1 kg	  2 ; plateau de cuisson recouvert de papier sulfurisé / grille métallique

7. FONCTIONS DE L'HORLOGE

7.1 Fonctions de l'horloge

Fonctions de l'horloge	Application
 Minuteur	Lorsque le minuteur termine le décompte, le signal sonore retentit.
 Heure de cuisson	Lorsque le minuteur termine le décompte, le signal sonore retentit et le mode de cuisson s'arrête.
 Départ différé	Pour reporter le début et / ou la fin de la cuisson.
 Compteur	Le maximum est de 23 h 59 min. Cette fonction n'a aucun effet sur le fonctionnement du four. Pour activer et désactiver le Compteur, sélectionnez : Menu , Configurations.

7.2 Comment régler : Fonctions de l'horloge

Comment régler Heure actuelle		
Étape 1	Étape 2	Étape 3

Comment régler Heure actuelle



Pour modifier l'heure actuelle, accédez au menu et sélectionnez Configurations, Heure actuelle.

Réglez l'horloge.

Appuyez sur **OK**.

Comment régler Minuteur

Étape 1



Appuyez sur : 

L'affichage indique :
0:00

Étape 2



Réglez la Minuteur

Étape 3



Appuyez sur **OK**.

 Le minuteur commence son décompte immédiatement.

Comment régler Heure de cuisson

Étape 1



Choisissez le mode de cuisson et réglez la température.

Étape 2



Appuyez à plusieurs reprises : 

L'affichage indique :
0:00

STOP

Étape 3



Réglez le temps de cuisson.

Étape 4



Appuyez sur **OK**.

 Le minuteur commence son décompte immédiatement.

Comment régler Départ différé

Étape 1



Sélectionnez le mode de cuisson.

Étape 2



Appuyez à plusieurs reprises : 

L'affichage indique :
l'heure actuelle
 DÉMARRER

Étape 3



Réglez l'heure de départ.

Étape 4



Appuyez sur **OK**.

L'affichage indique :
--:--
 ARRÊTER

Étape 5



Réglez l'heure de fin.

Étape 6



Appuyez sur **OK**.

 Le minuteur commence à compter à l'heure réglée.

8. UTILISATION DES ACCESSOIRES

AVERTISSEMENT!

Reportez-vous aux chapitres concernant la sécurité.

8.1 Insertion des accessoires

Une petite indentation sur le dessus apporte plus de sécurité. Les indentations sont

également des dispositifs anti-bascule. Le rebord élevé de la grille empêche les ustensiles de cuisine de glisser sur la grille.

Grille métallique:

Poussez la grille entre les barres de guidage des supports de grille.

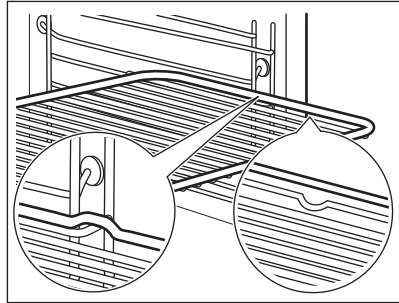

Plateau de cuisson / Plat à rôtir:

Poussez la plaque entre les rails du support de grille.

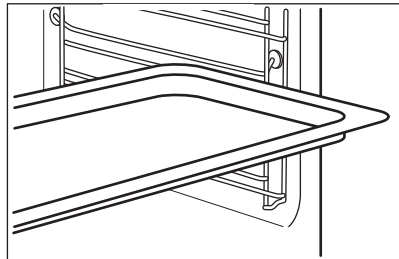

9. FONCTIONS SUPPLÉMENTAIRES

9.1 Touches Verrouil

Cette fonction permet d'éviter une modification involontaire de la fonction de l'appareil.

Activez-la lorsque l'appareil est allumé - la cuisson réglée est maintenue, le bandeau de commande est verrouillé.

Allumez-le lorsque l'appareil est éteint - il ne peut pas être allumé, le bandeau de commande est verrouillé.

Cette fonction permet d'éviter une modification involontaire de la fonction de l'appareil.





 - maintenez la touche enfoncée pour activer la fonction.
Un signal sonore retentit.

 - maintenez la touche enfoncée pour la désactiver.

 3 x  - clignote lorsque le verrouillage est activé.

9.2 Arrêt automatique

Pour des raisons de sécurité, si le mode de cuisson est actif et qu'aucun réglage n'est modifié, l'appareil s'éteint automatiquement au bout d'un certain temps.

 (°C)	 (h)
30 - 115	12.5
120 - 195	8.5
200 - 245	5.5

 (°C)

 (h)

250 -maximum

3

L'arrêt automatique ne fonctionne pas avec les fonctions suivantes : Eclairage four, Départ différé.

9.3 Ventilateur de refroidissement

Lorsque l'appareil fonctionne, le ventilateur de refroidissement se met automatiquement en marche pour refroidir les surfaces de l'appareil. Si vous éteignez l'appareil, le ventilateur de refroidissement peut continuer à fonctionner jusqu'à ce que l'appareil refroidisse.

10. CONSEILS

10.1 Recommandations de cuisson





Les températures et temps de cuisson se trouvant dans les tableaux ne sont indiqués qu'à titre indicatif. Ils varient selon les recettes, la qualité et la quantité des ingrédients utilisés.

Votre appareil peut cuire ou rôtir les aliments différemment de l'appareil que vous aviez auparavant. Les conseils ci-dessous contiennent les réglages de température, les temps de cuisson et les positions de grilles recommandés pour des types de plats en particulier.

Si vous ne trouvez pas les réglages appropriés pour une recette spécifique, cherchez-en une qui s'en rapproche.



10.2 Chaleur Tournante Humide

Pour de meilleurs résultats, suivez les suggestions indiquées dans le tableau ci-dessous.

	°C		
Gratin de pâtes	200 - 220	45 - 55	3
Gratin de pommes de terre	180 - 200	70 - 85	3
Moussaka	170 - 190	70 - 95	3
Lasagnes	180 - 200	75 - 90	3
Cannelloni	180 - 200	70 - 85	3
Pudding au pain	190 - 200	55 - 70	3
Gâteau de riz	170 - 190	45 - 60	3
Gâteau aux pommes, à base de mélange de génoise (moule à gâteau rond)	160 - 170	70 - 80	3
Pain Blanc	190 - 200	55 - 70	3

10.3 Chaleur Tournante Humide - accessoires recommandés

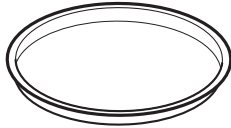
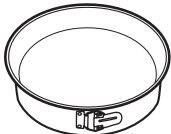
Utilisez les moules et récipients foncés et non réfléchissants. Ils offrent une meilleure absorption de la chaleur que les plats réfléchissants de couleur claire.





			
Plaque à pizza	Plat de cuisson	Ramequins	Moule pour fond de tarte
Sombre, non réfléchissant Diamètre de 28 cm	Sombre, non réfléchissant Diamètre : 26 cm	Céramique 8 cm de diamètre, 5 cm de hauteur	Sombre, non réfléchissant Diamètre de 28 cm





10.4 Tableaux de cuisson pour les instituts de tests

Informations pour les organismes de contrôle





Tests conformes aux normes : EN 60350, IEC 60350.

Cuisson sur un niveau - cuisson en moule





		 °C	 min	
Génoise allégée	Chaleur tournante	160	45 - 60	2
Génoise allégée	Chauffage Haut/Bas	160	45 - 60	2
Tarte aux pommes, 2 moules Ø20 cm	Chaleur tournante	160	55 - 65	2

		 °C	 min	
Tarte aux pommes, 2 moules Ø20 cm	Chauffage Haut/Bas	180	55 - 65	1
Sablé	Chaleur tournante	140	25 - 35	2
Sablé	Chauffage Haut/Bas	140	25 - 35	2

Cuisson sur un niveau - biscuits
Utilisez le troisième niveau de la grille.





		 °C	 min
Petits gâteaux, 20 par plateau, préchauffer le four à vide	Chaleur tournante	150	20 - 30
Petits gâteaux, 20 par plateau, préchauffer le four à vide	Chauffage Haut/Bas	170	20 - 30

Cuisson sur plusieurs niveaux - biscuits

		 °C	 min	
Sablé	Chaleur tournante	140	25 - 45	2 / 4
Petits gâteaux, 20 par plateau, préchauffer le four à vide	Chaleur tournante	150	25 - 35	1 / 4
Génoise allégée	Chaleur tournante	160	45 - 55	2 / 4
Tarte aux pommes, 1 pain moulé par grille (Ø 20 cm)	Chaleur tournante	160	55 - 65	2 / 4

Gril
Préchauffez le four vide pendant 5 minutes.

Réglez le gril à la température maximale.

		 min	
Pain grillé	Gril	1 - 2	5
Steak de bœuf, tourner à mi-cuis- son	Gril	24 - 30	4

11. ENTRETIEN ET NETTOYAGE

AVERTISSEMENT!

Reportez-vous aux chapitres concernant la sécurité.

11.1 Remarques concernant le nettoyage



Agent nettoyant

Nettoyez l'avant de l'appareil uniquement avec un chiffon en microfibre imbibé d'eau tiède et d'un détergent doux.

Utilisez une solution de nettoyage pour nettoyer les surfaces métalliques.

Nettoyez les taches avec un détergent doux.



Utilisation quotidienne

Nettoyez la cavité après chaque utilisation. L'accumulation de graisse ou d'autres résidus peut provoquer un incendie.

Ne conservez pas les aliments dans l'appareil pendant plus de 20 minutes. Séchez la cavité uniquement avec un chiffon en microfibre après chaque utilisation.



Accessoires

Nettoyez tous les accessoires après chaque utilisation et laissez-les sécher. Utilisez uniquement un chiffon en microfibre avec de l'eau tiède et un détergent doux. Ne lavez pas les accessoires au lave-vaisselle.

Ne nettoyez pas les accessoires anti-adhésifs avec un produit nettoyant abrasif ou des objets tranchants.

11.2 Comment retirer : Supports de grille

Retirez les supports de grille pour nettoyer le four.

Étape 1 Éteignez le four et attendez qu'il soit froid.

Étape 2 Écartez l'avant du support de grille de la paroi latérale.

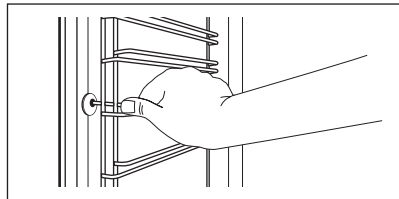

Étape 3 Écartez l'arrière du support de grille de la paroi latérale et retirez-le.

Étape 4 Installez les supports de grille dans l'ordre inverse.

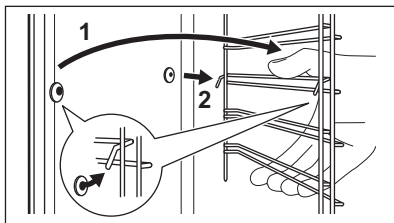

11.3 Comment utiliser : Nettoyage par pyrolyse

Nettoyez le four avec Nettoyage par pyrolyse.

AVERTISSEMENT!

Risque de brûlure.

ATTENTION!

Si un autre appareil est installé dans le même meuble, ne l'utilisez pas en même temps que cette fonction. Vous risqueriez d'endommager le four.

Avant le Nettoyage par pyrolyse :

Éteignez le four et attendez qu'il soit froid.

Retirez les accessoires et les supports de grille amovibles.

Nettoyez la sole du four et la vitre interne de la porte avec de l'eau tiède, un chiffon doux et un détergent doux.

Nettoyage par pyrolyse

Étape 1

Ouvrez le menu : Nettoyage  .

Option	Durée
C1 - Nettoyage léger	1 h
C2 - Nettoyage normal	1 h 30 min
C3 - Nettoyage complet	3 h

Étape 2



OK - appuyez pour définir le programme de nettoyage.

Étape 3

OK - appuyez pour démarrer le nettoyage.

Étape 4

Après le nettoyage, tournez la manette des modes de cuisson sur la position Arrêt.

 Lorsque le nettoyage commence, la porte du four se verrouille et l'éclairage s'éteint. Jusqu'à ce que la porte se déverrouille, l'affichage indique : .

Une fois le nettoyage terminé :

Éteignez le four et attendez qu'il soit froid.

Nettoyez la cavité avec un chiffon doux.

Retirez les résidus du fond de la cavité.

11.4 Nettoyage conseillé

Le four vous rappelle lorsque le nettoyage par pyrolyse est terminé.

 clignote sur l'affichage pendant 5 secondes après chaque session de cuisson.

Pour désactiver le rappel, accédez au Menu et sélectionnez Configurations, Nettoyage conseillé.

11.5 Comment démonter et installer : Porte

Vous pouvez retirer la porte ainsi que les panneaux de verre intérieurs pour les nettoyer. Le nombre de vitres diffère selon les modèles.

AVERTISSEMENT!

La porte est lourde.

ATTENTION!

Manipulez soigneusement la vitre, en particulier autour des bords du panneau avant. Le verre peut se briser.

Étape 1 Ouvrez entièrement la porte.

Étape 2 Soulevez et appuyez sur les leviers de blocage (A) sur les deux charnières de la porte.

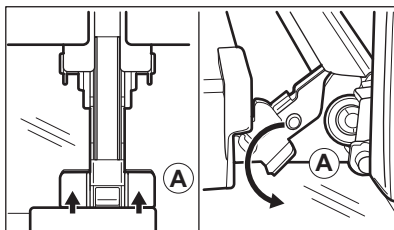

Étape 3 Fermez la porte du four à la première position (à un angle d'environ 70°). Tenez la porte des deux côtés et retirez-la du four en la soulevant. Posez la porte, face extérieure vers le bas, sur un linge doux posé sur une surface stable.

Étape 4 Tenez la garniture de porte (B) sur le bord supérieur de la porte des deux côtés et poussez vers l'intérieur pour libérer le joint du clip.

Étape 5 Retirez le cache de la porte en le tirant vers l'avant.

Étape 6 Saisissez les panneaux de verre de la porte par leur bord supérieur un par un et dégagez-les du guide.

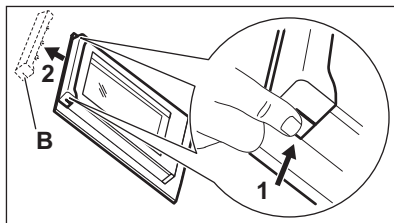

Étape 7 Nettoyez la vitre à l'eau savonneuse. Essuyez soigneusement la vitre. Ne passez pas les panneaux en verre au lave-vaisselle.

Étape 8 Après le nettoyage, effectuez les étapes ci-dessus dans le sens inverse.

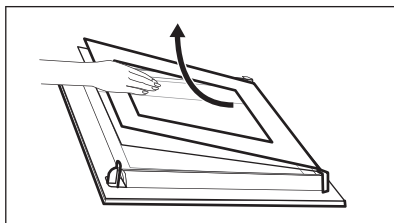

Étape 9 Installez d'abord le plus petit des panneaux, puis le plus grand, et terminez par la porte.

11.6 Comment remplacer : Éclairage



AVERTISSEMENT!

Risque d'électrocution.
L'éclairage peut être chaud.

Avant de remplacer l'éclairage :

Étape 1	Étape 2	Étape 3
Éteignez le four. Attendez que le four ait refroidi.	Débranchez le four de l'alimentation secteur.	Placez un chiffon au fond de la cavité.

Lampe supérieure

Étape 1 Tournez le diffuseur en verre pour le retirer.

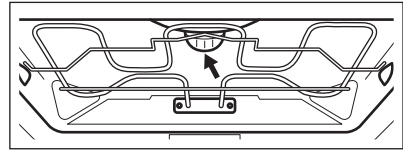

Étape 2 Nettoyez le diffuseur en verre.

Étape 3 Remplacez l'ampoule par une ampoule adéquate résistant à une température de 300 °C.

Étape 4 Installez le diffuseur en verre.

12. DÉPANNAGE



AVERTISSEMENT!

Reportez-vous aux chapitres concernant la sécurité.

12.1 Que faire si...

Dans tous les cas ne figurant pas dans ce tableau, veuillez contacter un service après-vente agréé.



L'appareil ne s'allume pas ou ne chauffe pas

Problème	Vérifiez si...
Vous ne pouvez ni activer ni faire fonctionner l'appareil.	L'appareil est correctement branché à l'électricité.
L'appareil ne chauffe pas.	L'arrêt automatique est désactivé.
L'appareil ne chauffe pas.	La porte de l'appareil est fermée.
L'appareil ne chauffe pas.	Le fusible n'a pas disjoncté.



L'appareil ne s'allume pas ou ne chauffe pas

L'appareil ne chauffe pas.

Le verrouillage est désactivé.



Composants

Problème

Vérifiez si...

L'éclairage est éteint.

La Chaleur Tourmente Humide est activée.

L'éclairage ne fonctionne pas.

L'ampoule est grillée.



Codes d'erreur

L'affichage indique...

Vérifiez si...

Err C3

La porte de l'appareil est fermée ou le verrouillage de la porte n'est pas cassé.

Err F102

La porte de l'appareil est fermée.

Err F102

Le verrouillage de la porte n'est pas cassé.

00:00

Une coupure de courant s'est produite. Réglez l'heure actuelle.

Si l'affichage indique un code d'erreur qui ne figure pas dans ce tableau, désactivez et réenclenchez le fusible de l'habitation pour redémarrer l'appareil. Si le code d'erreur réapparaît, contactez un service après-vente agréé.

12.2 Données de maintenance

Si vous ne trouvez pas de solution au problème, veuillez contacter votre revendeur ou un service après-vente agréé.

Les informations nécessaires au service après-vente figurent sur la plaque signalétique. La plaque signalétique se trouve sur le cadre avant de la cavité de l'appareil. Ne retirez pas la plaque signalétique de la cavité de l'appareil.

Nous vous recommandons d'écrire les informations ici :

Modèle (Mod.)

Référence produit (PNC)

Numéro de série (SN)

13. RENDEMENT ÉNERGÉTIQUE

13.1 Informations sur le produit et fiche d'information sur le produit conformément aux réglementations européennes sur l'écoconception et l'étiquetage énergétique

Nom du fournisseur

AEG

Identification du modèle	BPK535060B 944188596 BPK535060M 944188597	
Indice d'efficacité énergétique	81.2	
Classe d'efficacité énergétique	A+	
Consommation d'énergie avec charge standard, en mode conventionnel	1.09 kWh/cycle	
Consommation d'énergie avec charge standard, en mode chaleur tournante	0.69 kWh/cycle	
Nombre de cavités	1	
Source de chaleur	Électricité	
Volume	71 l	
Type de four	Four encastrable	
Masse	BPK535060B	35.0 kg
	BPK535060M	35.0 kg

IEC/EN 60350-1 - Appareils de cuisson domestiques électriques - Partie 1 : Cuisinières, fours, fours à vapeur et grils : Méthodes de mesure des performances.

13.2 Économie d'énergie



Cet appareil est doté de caractéristiques qui vous permettent d'économiser de l'énergie lors de votre cuisine au quotidien.

Assurez-vous que la porte de l'appareil est fermée lorsque l'appareil est en fonctionnement. Évitez d'ouvrir l'appareil trop souvent pendant la cuisson. Nettoyez régulièrement le joint de porte et assurez-vous qu'il est bien en place.

Utilisez des plats en métal pour accroître les économies d'énergie.

Dans la mesure du possible, ne préchauffez pas l'appareil avant la cuisson.

Lorsque vous préparez plusieurs plats à la fois, faites en sorte que les pauses entre les cuissons soient aussi courtes que possible.

Cuisson avec ventilation

Si possible, utilisez les fonctions de cuisson avec la ventilation pour économiser de l'énergie.

Chaleur résiduelle

L'éclairage et le ventilateur continuent de fonctionner. Lorsque vous mettez à l'arrêt l'appareil, l'affichage montre la chaleur résiduelle. Vous pouvez utiliser cette chaleur pour le maintien au chaud des aliments.

Si la cuisson doit durer plus de 30 minutes, réduisez la température de l'appareil au minimum 3 à 10 minutes avant la fin de la cuisson. La chaleur résiduelle à l'intérieur de l'appareil poursuivra la cuisson.

Utilisez la chaleur résiduelle pour réchauffer d'autres plats.

Maintien des aliments au chaud

Sélectionnez la température la plus basse possible pour utiliser la chaleur résiduelle et maintenir le repas au chaud. La température ou le voyant de chaleur résiduelle s'affichent.

Cuisson avec l'éclairage éteint

Éteignez l'éclairage en cours de cuisson. Ne l'allumez que lorsque vous en avez besoin.

Chaleur Tournante Humide







Fonction conçue pour économiser de l'énergie en cours de cuisson.

Lorsque vous utilisez cette fonction, l'éclairage s'éteint automatiquement au bout

de 30 secondes. Vous pouvez rallumer l'éclairage, mais cela réduira les économies d'énergie.

14. STRUCTURE DES MENUS

14.1 Menu

Étape 1	Étape 2	Étape 3	Étape 4	Étape 5
				
 - sélectionnez pour accéder au Menu .	Sélectionnez l'option dans la structure Menu et appuyez sur OK .	Sélectionnez la configuration.	OK . appuyez pour confirmer le réglage.	Ajustez la valeur et appuyez sur OK .

Tournez la manette des modes de cuisson sur la position Arrêt pour quitter le Menu .

Structure du Menu

Cuisson assistée 

Nettoyage 

Configurations 

Configurations

01	Heure actuelle	Modifier	02	Affichage Luminosité	1 - 5
03	Son touches	1 - Bip 2 - Clic 3 - Son désactivé	04	Volume alarme	1 - 4
05	Compteur	Marche / Arrêt	06	Eclairage four	Marche / Arrêt
07	Préchauffage rapide	Marche / Arrêt	08	Nettoyage conseillé	Marche / Arrêt
09	Mode démo	Code d'activation : 2468	10	Version du logiciel	Contrôle
11	Réinitialiser tous les réglages	Oui/Non			

15. EN MATIÈRE DE PROTECTION DE L'ENVIRONNEMENT

Recyclez les matériaux portant le symbole . Déposez les emballages dans les conteneurs prévus à cet effet. Contribuez à la protection de l'environnement et à votre

sécurité, recyclez vos produits électriques et électroniques. Ne jetez pas les appareils portant le symbole  avec les ordures ménagères. Emmenez un tel produit dans

votre centre local de recyclage ou contactez vos services municipaux.

FR Concerne la France uniquement :



FR

Cet appareil, ses accessoires et cordons se recyclent

REPRISE
À LA LIVRAISON



OU

À DÉPOSER
EN MAGASIN



OU

À DÉPOSER
EN DÉCHÈTERIE



Points de collecte sur www.quefairedemesdechets.fr
Privilégiez la réparation ou le don de votre appareil !



FR



Willkommen bei AEG! Danke, dass du dich für unser Gerät entschieden hast.



Hole dir Anwendungshinweise, Prospekte, Fehlerbehebungs-, Service- und Reparatur-Informationen unter aeg.com/support.



Für weitere Rezepte, Tipps und Fehlerbehebung lade die App **My AEG Kitchen** herunter.



Änderungen vorbehalten.

INHALTSVERZEICHNIS

1. SICHERHEITSHINWEISE.....	105
2. SICHERHEITSANWEISUNGEN.....	107
3. GERÄTEBESCHREIBUNG.....	111
4. BEDIENFELD.....	111
5. VOR DER ERSTEN VERWENDUNG.....	112
6. TÄGLICHER GEBRAUCH.....	113
7. UHRFUNKTIONEN.....	118
8. VERWENDUNG DES ZUBEHÖRS.....	119
9. ZUSATZFUNKTIONEN.....	120
10. TIPPS UND HINWEISE.....	121
11. REINIGUNG UND PFLEGE.....	123
12. FEHLERSUCHE.....	127
13. ENERGIEEFFIZIENZ.....	128
14. MENÜSTRUKTUR.....	129
15. INFORMATIONEN ZUR ENTSORGUNG.....	130

1. ⚠ SICHERHEITSHINWEISE

Lesen Sie vor der Montage und dem Gebrauch des Geräts zuerst die Bedienungsanleitung. Bei Verletzungen oder Schäden infolge nicht ordnungsgemäßer Montage oder Verwendung übernimmt der Hersteller keine Haftung. Bewahren Sie die Anleitung zum Nachschlagen an einem sicheren und zugänglichen Ort auf.

1.1 Sicherheit von Kindern und schutzbedürftigen Personen

- Das Gerät kann von Kindern ab 8 Jahren und Personen mit eingeschränkten physischen, sensorischen oder geistigen

Fähigkeiten oder mit mangelnder Erfahrung/mangelndem Wissen benutzt werden, wenn sie durch eine für ihre Sicherheit zuständige Person beaufsichtigt werden oder von dieser Person Anweisungen erhalten haben, wie das Gerät sicher zu bedienen ist und welche Gefahren bei nicht ordnungsgemäßer Bedienung bestehen. Kinder unter 8 Jahren und Personen mit schweren Behinderungen oder Mehrfachbehinderung sollten vom Gerät ferngehalten werden, wenn sie nicht ständig beaufsichtigt werden.

- Kinder sollten beaufsichtigt werden, um sicherzustellen, dass sie nicht mit dem Gerät.
- Halten Sie sämtliches Verpackungsmaterial von Kindern fern und entsorgen Sie es ordnungsgemäß.
- **WARNUNG:** Das Gerät und die zugänglichen Geräteteile werden während des Betriebs heiß. Halten Sie Kinder und Haustiere von dem Gerät fern, wenn es in Betrieb oder in der Abkühlphase ist.
- Falls Ihr Gerät mit einer Kindersicherung ausgestattet ist, empfehlen wir, diese einzuschalten.
- Kinder dürfen keine Reinigung und Wartung des Geräts ohne Beaufsichtigung durchführen.

1.2 Allgemeine Sicherheit

- Dieses Gerät ist nur zum Kochen bestimmt.
- Dieses Gerät ist für den häuslichen Gebrauch im Haushalt in Innenräumen konzipiert.
- Dieses Gerät darf in Büros, Hotelzimmern, Gästezimmern in Pensionen, Bauernhöfen und anderen ähnlichen Unterkünften verwendet werden, wenn diese Nutzung das (durchschnittliche) Nutzungsniveau im Haushalt nicht überschreitet.
- Die Montage des Geräts und der Austausch des Kabels muss von einer Fachkraft vorgenommen werden.
- Verwenden Sie das Gerät nicht, bevor es in den Einbauschrank gesetzt wird.

- Vor Wartungsarbeiten ist das Gerät von der elektrischen Stromversorgung zu trennen.
- Wenn das Netzkabel beschädigt ist, muss es vom Hersteller, seinem autorisierten Kundenservice oder einer gleichermaßen qualifizierten Person ausgetauscht werden, um Gefahren durch elektrischen Strom zu vermeiden.
- **WARNUNG:** Vergewissern Sie sich, dass das Gerät ausgeschaltet ist, bevor Sie die Lampe austauschen, um einen Stromschlag zu vermeiden.
- **ACHTUNG:** Das Gerät und die zugänglichen Geräteteile werden während des Betriebs heiß. Es ist darauf zu achten, die Heizelemente oder die Oberfläche des Garraums nicht zu berühren.
- Verwenden Sie stets Topfhandschuhe, um Zubehör oder Geschirr herauszunehmen oder zu verstauen.
- Ziehen Sie die Einhängegitter zuerst vorne und dann hinten von den Seitenwänden weg. Setzen Sie die Einhängegitter in umgekehrter Reihenfolge ein.
- Reinigen Sie das Gerät nicht mit einem Dampfstrahlreiniger.
- Benutzen Sie zum Reinigen der Glastür keine scharfen Scheuermittel oder Metallschwämmchen; sie könnten die Glasfläche verkratzen und zum Zersplittern der Scheibe führen.
- Entfernen Sie vor der pyrolytischen Reinigung alle Zubehörteile und übermäßige Ansammlungen/ Ablagerungen aus dem Innenraum des Geräts.

2. SICHERHEITSANWEISUNGEN

2.1 Montage

WARNUNG!

Nur eine qualifizierte Fachkraft darf die Montage des Geräts vornehmen.

- Entfernen Sie das gesamte Verpackungsmaterial.

- Montieren Sie ein beschädigtes Gerät nicht und benutzen Sie es nicht.
- Halten Sie sich an die mitgelieferte Montageanleitung.
- Seien Sie beim Umsetzen des Gerätes vorsichtig, da es sehr schwer ist. Tragen Sie stets Sicherheitshandschuhe und festes Schuhwerk.
- Ziehen Sie das Gerät nicht am Griff.

- Montieren Sie das Gerät an einem sicheren und geeigneten Ort, der den Montageanforderungen entspricht.
- Die Mindestabstände zu anderen Geräten und Küchenmöbeln sind einzuhalten.
- Überprüfen Sie vor der Montage des Gerätes, ob sich die Gerätetür ungehindert öffnen lässt.
- Das Gerät ist mit einem elektrischen Kühlsystem ausgestattet. Es muss mit der elektrischen Stromversorgung betrieben werden.
- Das Einbaugerät muss die Stabilitätsanforderungen von DIN 68930 erfüllen.

Mindesthöhe des Einbaumöbels (Mindesthöhe des Schrankes unter der Arbeitsplatte)	578 (600) mm
Schrankbreite	560 mm
Schrantiefe	550 (550) mm
Höhe der Gerätevorderseite	594 mm
Höhe der Geräterückseite	576 mm
Breite der Gerätevorderseite	595 mm
Breite der Geräterückseite	559 mm
Gerätetiefe	567 mm
Geräteeinbautiefe	546 mm
Tiefe bei geöffneter Tür	1027 mm
Mindestgröße der Belüftungsöffnung. Öffnung auf der Rückseite unten	560x20 mm
Länge des Netzanschlusskabels. Das Kabel befindet sich in der rechten Ecke auf der Rückseite	1500 mm
Befestigungsschrauben	4x25 mm

2.2 Elektrischer Anschluss



WARNUNG!

Brand- und Stromschlaggefahr.

- Alle elektrischen Anschlüsse sind von einem geprüften Elektriker vorzunehmen.
- Das Gerät muss geerdet sein.

- Stellen Sie sicher, dass die Daten auf dem Typenschild mit den elektrischen Nennwerten der Netzspannung übereinstimmen.
- Schließen Sie das Gerät nur an eine ordnungsgemäß installierte Schutzkontaktsteckdose an.
- Verwenden Sie keine Mehrfachsteckdosen oder Verlängerungskabel.
- Achten Sie darauf, Netzstecker und Netzkabel nicht zu beschädigen. Falls das Netzkabel des Geräts ersetzt werden muss, lassen Sie diese Arbeit durch unseren autorisierten Kundendienst durchführen.
- Achten Sie darauf, dass das Netzkabel die Gerätetür oder die Nische unter dem Gerät nicht berührt oder in ihre Nähe gelangt, insbesondere wenn das Gerät eingeschaltet oder die Tür heiß ist.
- Alle Teile, die gegen direktes Berühren schützen, sowie die isolierten Teile müssen so befestigt werden, dass sie nicht ohne Werkzeug entfernt werden können.
- Stecken Sie den Netzstecker erst nach Abschluss der Montage in die Steckdose. Stellen Sie sicher, dass der Netzstecker nach der Montage noch zugänglich ist.
- Falls die Steckdose lose ist, schließen Sie den Netzstecker nicht an.
- Ziehen Sie nicht am Netzkabel, wenn Sie das Gerät von der Stromversorgung trennen möchten. Ziehen Sie stets am Netzstecker.
- Verwenden Sie nur geeignete Trenneinrichtungen: Überlastschalter, Sicherungen (Schraubsicherungen müssen aus dem Halter entfernt werden können), Fehlerstromschutzschalter und Schütze.
- Die elektrische Installation muss eine Trenneinrichtung aufweisen, mit der Sie das Gerät allpolig von der Stromversorgung trennen können. Die Trenneinrichtung muss mit einer Kontaktöffnungsbreite von mindestens 3 mm ausgeführt sein.
- Schließen Sie die Gerätetür ganz, bevor Sie den Netzstecker in die Steckdose stecken.
- Das Gerät wird mit einem Netzstecker und Netzkabel geliefert.

2.3 Gebrauch

WARNUNG!

Verletzungs-, Verbrennungs-, Stromschlag- oder Explosionsgefahr.

- Nehmen Sie keine technischen Änderungen am Gerät vor.
- Vergewissern Sie sich, dass die Lüftungsöffnungen nicht blockiert sind.
- Lassen Sie das Gerät während des Betriebs nicht unbeaufsichtigt.
- Schalten Sie das Gerät nach jedem Gebrauch aus.
- Gehen Sie beim Öffnen der Tür vorsichtig vor, wenn das Gerät in Betrieb ist. Es kann heiße Luft freigesetzt werden.
- Benutzen Sie das Gerät nicht mit nassen Händen oder wenn es mit Wasser Kontakt hat.
- Üben Sie keinen Druck auf die offene Tür aus.
- Verwenden Sie das Gerät nicht als Arbeits- oder Abstellfläche.
- Öffnen Sie die Gerätetür vorsichtig. Die Verwendung von Zutaten mit Alkohol kann eine Mischung aus Alkohol und Luft verursachen.
- Lassen Sie beim Öffnen der Tür keine Funken oder offenen Flammen mit dem Gerät in Kontakt kommen.
- Platzieren Sie keine entflammaren Produkte oder Gegenstände, die mit entflammaren Produkten benetzt sind, im Gerät, auf dem Gerät oder in der Nähe des Geräts.

WARNUNG!

Risiko von Schäden am Gerät.

- Um Beschädigungen und Verfärbungen der Emailbeschichtung zu vermeiden:
 - Stellen Sie feuerfestes Geschirr oder andere Gegenstände nicht direkt auf den Boden des Geräts.
 - Legen Sie keine Alufolie direkt auf den Boden des Garraums.
 - Füllen Sie kein Wasser direkt in das heiße Gerät.
 - Lassen Sie nach Abschluss des Garvorgangs kein feuchtes Geschirr oder feuchte Speisen im Gerät stehen.

- Gehen Sie beim Herausnehmen oder Einsetzen des Zubehörs sorgfältig vor.
- Verfärbungen der Emaille- oder Edelstahlbeschichtung haben keine Auswirkung auf die Leistung des Geräts.
- Verwenden Sie eine tiefe Pfanne für feuchte Kuchen. Fruchtsäfte verursachen Flecken, die dauerhaft sein können.
- Kochen Sie immer bei geschlossener Gerätetür.
- Ist das Gerät hinter einer Möbelfront (wie etwa einer Tür) installiert, achten Sie darauf, dass die Tür während des Gerätebetriebs nicht geschlossen wird. Hinter einer geschlossenen Möbelfront können sich Hitze und Feuchtigkeit ansammeln und das Gerät, das Gehäuse oder den Boden beschädigen. Schließen Sie die Möbelfront nicht, bevor das Gerät nach dem Gebrauch völlig abgekühlt ist.

2.4 Reinigung und Pflege

WARNUNG!

Verletzungsgefahr, Brandgefahr oder Beschädigung des Geräts.

- Vor Wartungsarbeiten das Gerät deaktivieren und den Stecker des Anschlusskabels aus der Steckdose ziehen.
- Vergewissern Sie sich, dass das Gerät abgekühlt ist. Es besteht die Gefahr, dass die Glasscheiben brechen.
- Ersetzen Sie die Türglasscheiben umgehend, wenn sie beschädigt sind. Wenden Sie sich an einen autorisierten Kundendienst.
- Gehen Sie beim Aushängen der Tür vorsichtig vor. Die Tür ist schwer!
- Reinige das Gerät regelmäßig, um eine Verschlechterung des Oberflächenmaterials zu verhindern.
- Reinige das Gerät mit einem feuchten, weichen Lappen. Verwende ausschließlich Neutralreiniger. Verwende keine Scheuermittel, Scheuerschwämme, scharfe Reinigungsmittel oder Metallgegenstände.
- Falls Sie ein Backofenspray verwenden, befolgen Sie die Sicherheitsanweisungen auf seiner Verpackung.

2.5 Pyrolytische Reinigung

WARNUNG!

Im Pyrolyse-Modus besteht Verletzungs- und Brandgefahr und es können chemische Emissionen (Dämpfe) austreten.

- Entfernen Sie vor der Pyrolyse und dem ersten Vorheizen Folgendes aus dem Garraum:
 - Speisereste, Öl oder Fettansammlungen / -ablagerungen.
 - Alle abnehmbaren Gegenstände (die mit dem Gerät mitgeliefert werden, wie z. B. Regale, Seitenleisten usw.), insbesondere alle antihaftbeschichteten Töpfe, Pfannen, Backbleche, Utensilien usw.
- Lesen Sie sorgfältig alle Anweisungen zur pyrolytischen Reinigung durch.
- Halten Sie Kinder während der Pyrolyse vom Gerät fern. Das Gerät wird sehr heiß und die heiße Luft wird durch die vorderen Kühllüftungsöffnungen freigesetzt.
- Die pyrolytische Reinigung erfolgt bei sehr hoher Temperatur und kann Dämpfe von Lebensmittelrückständen und Gerätematerialien freisetzen. Beachten Sie Folgendes:
 - Sorgen Sie während und nach der Pyrolyse für eine gute Belüftung.
 - Sorgen Sie während und nach dem ersten Vorheizen für eine gute Belüftung.
- Während und nach der Pyrolyse kein Wasser auf die Backofentür geben, um eine Beschädigung der Glasscheiben zu vermeiden.
- Die von den Pyrolyse-Backöfen / Speiseresten freigesetzten Dämpfe sind ungefährlich für Menschen, einschließlich Kinder und Personen mit Gesundheitsproblemen.
- Halten Sie Haustiere während und nach der Pyrolyse und dem ersten Aufheizen vom Gerät fern. Kleine Haustiere (insbesondere Vögel und Reptilien) können sehr empfindlich auf Temperaturschwankungen und emittierte Dämpfe reagieren.
- Antihaftbeschichtungen auf Töpfen, Pfannen, Backblechen und Kochutensilien

usw. können durch die hohen Temperaturen während der pyrolytischen Reinigung aller pyrolytischen Backöfen beschädigt werden und geringfügige Mengen an gesundheitsschädlichen Dämpfen freisetzen.

2.6 Innenbeleuchtung

WARNUNG!

Stromschlaggefahr.

- Bezüglich der Lampe(n) in diesem Gerät und separat verkaufter Ersatzlampen: Diese Lampen müssen extremen physikalischen Bedingungen in Haushaltsgeräten standhalten, wie z.B. Temperatur, Vibration, Feuchtigkeit, oder sollen Informationen über den Betriebszustand des Gerätes anzeigen. Sie sind nicht für den Einsatz in anderen Geräten vorgesehen und nicht für die Raumbelichtung geeignet.
- Dieses Produkt enthält eine Lichtquelle der Energieeffizienzklasse G.
- Verwenden Sie nur Lampen mit der gleichen Leistung .

2.7 Wartung

- Wenden Sie sich zur Reparatur des Geräts an den autorisierten Kundendienst.
- Dabei dürfen ausschließlich Originalersatzteile verwendet werden.

2.8 Entsorgung

WARNUNG!

Verletzungs- und Erstickungsgefahr.

- Informationen zur Entsorgung des Geräts erhalten Sie von Ihrer Gemeindeverwaltung.
- Trennen Sie das Gerät von der Stromversorgung.
- Schneiden Sie das Netzkabel in der Nähe des Geräts ab, und entsorgen Sie es.
- Entfernen Sie das Türschloss, um zu verhindern, dass sich Kinder, oder Haustiere im Gerät einschließen.

3. GERÄTEBESCHREIBUNG

3.1 Gesamtansicht

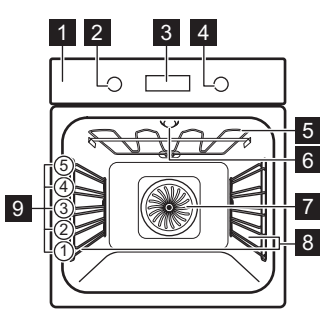

- 1 Bedienfeld
- 2 Einstellknopf für die Ofenfunktionen
- 3 Display
- 4 Einstellknopf
- 5 Heizelement
- 6 Lampe
- 7 Ventilator
- 8 Einschubschienen, herausnehmbar
- 9 Einschubebenen

3.2 Zubehör

Kombirost

Für Kochgeschirr, Kuchenformen, Braten.

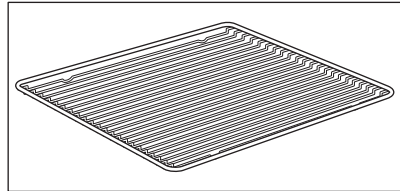

Backblech

Für Kuchen und Plätzchen.

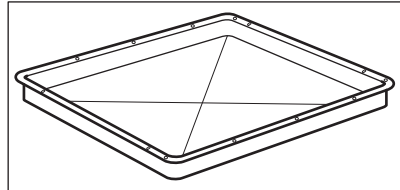

Brat- und Fettpfanne

Zum Backen und Braten oder zum Auffangen von abtropfendem Fett.

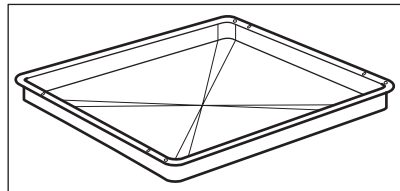

4. BEDIENFELD





4.1 Versenkbare Knöpfe

Drücken Sie zum Benutzen des Geräts den Knopf. Der Knopf kommt dann heraus.

4.2 Überblick – Bedienfeld

Wählen Sie eine Ofenfunktion, um das Gerät einzuschalten. Drehen Sie den Knopf für die

Ofenfunktionen in die Aus-Position, um das Gerät auszuschalten.

				OK
Kurzzeitwecker	Schnellaufheizung	Backofenbeleuchtung	Tastensperre	Bestätigen Sie die Einstellung

4.3 Display

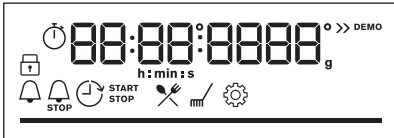

Display mit Tastenfunktionen.

Display-Anzeigen

Grundlegende Anzeigen

				
Verriegelung	Koch-Assistent	Reinigung	Einstellungen	Schnellaufheizung

Timer-Anzeigen

			
Kurzzeit-Wecker	STOP Ende	Zeitvorwahl	Uptimer

Fortschrittsbalken - für Temperatur oder Zeit.
Der Balken ist vollständig rot, wenn das Gerät die eingestellte Temperatur erreicht.



5. VOR DER ERSTEN VERWENDUNG

WARNUNG!

Siehe Kapitel Sicherheitshinweise.

5.1 Erste Reinigung

Reinigen Sie vor dem ersten Gebrauch das leere Gerät und stellen Sie die Uhrzeit ein:



00:00

Stellen Sie die Zeit ein. Drücken Sie **OK**.

5.2 Erstes Vorheizen

Den leeren Ofen vor der ersten Inbetriebnahme vorheizen.

Schritt 1 Entfernen Sie alle Zubehörteile und die herausnehmbaren Einhängegitter aus dem Backofen.

Schritt 2 Stellen Sie die Höchsttemperatur für folgende Funktion ein: 
Lassen Sie den Ofen 1 Std lang eingeschaltet.

Schritt 3 Stellen Sie die Höchsttemperatur für folgende Funktion ein: 
Lassen Sie den Ofen 15 Min lang eingeschaltet.

 Der Ofen kann während des Vorheizens Geruch und Rauch verströmen. Stellen Sie sicher, dass der Raum belüftet ist.

6. TÄGLICHER GEBRAUCH

WARNUNG!





Siehe Kapitel Sicherheitshinweise.







6.1 Einstellung: Ofenfunktionen

Schritt 1 Drehen Sie den Knopf für die Ofenfunktionen und wählen Sie eine Ofenfunktion.

Schritt 2 Drehen Sie den Bedienknopf, um die Temperatur einzustellen.

6.2 Ofenfunktionen

Ofenfunktion	Anwendung
 Heißluft	Zum Backen auf bis zu 3 Einschubebenen gleichzeitig und zum Dörren. Stelle eine 20 - 40 °C niedrigere Temperatur als bei Ober-/Unterhitze ein.
 Ober-/Unterhitze	Backen und Braten von Speisen auf einer Einschubebene.
 Tiefkühlgerichte	Lässt Fertiggerichte (z. B. Pommes frites, Kartoffelspalten oder Frühlingsrollen) schön knusprig werden.
 Pizzastufe	Zum Backen von Pizza. Für ein intensives Überbacken und einen knusprigen Boden.

Ofenfunktion	Anwendung
 <p>Unterhitze</p>	Zum Backen von Kuchen mit knusprigen Böden und zum Einkochen von Lebensmitteln.
 <p>Auftauen</p>	Zum Auftauen von Lebensmitteln (Gemüse und Obst). Die Auftauzeit hängt von der Menge und Größe der gefrorenen Lebensmittel ab.
 <p>Feuchte Umluft</p>	Diese Funktion ist darauf ausgelegt, beim Kochen Energie zu sparen. Wenn du diese Funktion verwendest, kann die Temperatur im Gerät von der eingestellten Temperatur abweichen. Die Restwärme wird verwendet. Der Heizstrom kann reduziert werden. Weitere Informationen findest du im Kapitel „Tägliche Verwendung“, Hinweise zu: Feuchte Umluft.
 <p>Grill</p>	Zum Grillen dünner Lebensmittel und zum Toasten von Brot.
 <p>Heißluftgrillen</p>	Zum Braten großer Fleischstücke oder von Geflügel mit Knochen auf einer Ebene. Gratinieren und Überbacken.
 <p>Menü</p>	Aufrufen des Menüs: Koch-Assistent, Reinigung, Einstellungen.

6.3 Hinweise zum: Feuchte Umluft

Diese Funktion wurde zur Einhaltung der Energieeffizienzklassen- und Umweltdesignanforderungen (gemäß EU 65/2014 und EU 66/2014) verwendet. Tests gemäß: IEC/EN 60350-1.

Die Backofentür sollte während des Garvorgangs geschlossen bleiben, damit die Funktion nicht unterbrochen wird. So wird gewährleistet, dass der Backofen mit der höchsten Energieeffizienz arbeitet.

Wenn Sie diese Funktion verwenden, schaltet sich die Backofenbeleuchtung automatisch nach 30 Sekunden aus.

Kochanweisungen finden Sie im Kapitel „Tipps und Hinweise“, Feuchte Umluft. Allgemeine Empfehlungen zum Energiesparen finden Sie im Kapitel „Energieeffizienz“, Energiesparen.

6.4 Einstellen: Koch-Assistent

Jedes Gericht in diesem Untermenü hat eine empfohlene Ofenfunktion und Temperatur. Verwenden Sie die Funktion, um ein Gericht schnell mit den Standardeinstellungen zuzubereiten. Sie können auch die Zeit und Temperatur während des Garvorgangs einstellen.

Wenn die Funktion beendet ist, prüfen Sie, ob das Gericht fertig ist.

Einige der Speisen können Sie auch mit der folgenden Funktion zubereiten: • Gewichtsautomatik

Schritt 1	Schritt 2	Schritt 3	Schritt 4
-----------	-----------	-----------	-----------



Öffnen Sie das Menü.



Wählen Sie Koch-Assistent. Drücken Sie **OK**.



Wählen Sie das Gericht. Drücken Sie **OK**.



Geben Sie das Gericht in den Backofen. Bestätigen Sie die Einstellung.

6.5 Koch-Assistent

Legende



Gewichtsautomatik verfügbar.

Legende











































Heize das Gerät vor, bevor du mit dem Kochen beginnst.





Einschubebene.

	Speise	Gewicht	Einschubebene / Zubehör
P1	Roastbeef, blutig		
P2	Roastbeef, rosa	1 - 1,5 kg; 4 – 5 cm dicke Stücke	2; Backblech Brate das Fleisch einige Minuten in einer heißen Pfanne. In das Gerät einlegen.
P3	Roastbeef, durch		
P4	Steak, rosa	180 - 220 g pro Stück; 3 cm dicke Scheiben	3; Bräter auf Kombirost Brate das Fleisch einige Minuten in einer heißen Pfanne. In das Gerät einlegen.
P5	Rinderbraten / geschmort (Prime Rib, obere runde, dicke Flanke)	1,5 - 2 kg	2; Bräter auf Kombirost Brate das Fleisch einige Minuten in einer heißen Pfanne. Flüssigkeit hinzugeben. In das Gerät einlegen.
P6	Roastbeef, blutig (Niedertemperatur-Garen)		
P7	Roastbeef, rosa (Niedertemperatur-Garen)	1 - 1,5 kg; 4 – 5 cm dicke Stücke	2; Backblech Verwende deine Lieblingsgewürze oder einfach Salz und frisch gemahlene Pfeffer. Brate das Fleisch einige Minuten in einer heißen Pfanne. In das Gerät einlegen.
P8	Roastbeef, durch (Niedertemperatur-Garen)		
P9	Rindfleischfilet, blutig (Niedertemperatur Garen)		
P10	Rindfleischfilet, rosa (Niedertemperatur Garen)	0,5 – 1,5 kg; 5 – 6 cm dicke Stücke	2; Backblech Verwende deine Lieblingsgewürze oder einfach Salz und frisch gemahlene Pfeffer. Brate das Fleisch einige Minuten in einer heißen Pfanne. In das Gerät einlegen.
P11	Rindfleischfilet, fertig (Niedertemperatur Garen)		





	Speise	Gewicht	Einschubebene / Zubehör
P12	Kalbsbraten (z. B. Schulter)	0.8 - 1.5 kg; 4 cm dicke Stücke	 2; Bräter auf Kombirost Verwende deine Lieblingsgewürze. Flüssigkeit hinzugeben. Braten zugedeckt.
P13	Schweinebraten Nacken oder Schulter	1.5 - 2 kg	 2; Bräter auf Kombirost Wende das Fleisch nach der Hälfte der Garzeit.
P14	Pulled Pork (Niedertemperatur Garen)	1.5 - 2 kg	 2; Backblech Verwende deine Lieblingsgewürze. Wende das Fleisch nach der Hälfte der Garzeit, um eine gleichmäßige Bräunung zu erzielen.
P15	Schweinelende, frisch	1 - 1.5 kg; 5 - 6 cm dicke Stücke	 2; Bräter auf Kombirost Verwende deine Lieblingsgewürze.
P16	Schweinefleisch-Spareribs	2 - 3 kg; verwende rohe, 2 - 3 cm dünne Spare Ribs	 3; tiefe Pfanne Flüssigkeit hinzufügen, um den Boden eines Gerichts zu bedecken. Wende das Fleisch nach der Hälfte der Garzeit.
P17	Lammkeule mit Knochen	1.5 - 2 kg; 7 - 9 cm dicke Stücke	 2; Bräter auf Backblech Flüssigkeit hinzugeben. Wende das Fleisch nach der Hälfte der Garzeit.
P18	Hähnchen, ganz	1 - 1.5 kg; frisch	  2; Auflaufform auf Backblech Verwende deine Lieblingsgewürze. Das Hähnchen nach der Hälfte der Garzeit wenden, um eine gleichmäßige Bräunung zu erzielen.
P19	Halbes Hähnchen	0.5 - 0.8 kg	 3; Backblech Verwende deine Lieblingsgewürze.
P20	Hähnchenbrust	180 - 200 g pro Stück	  2; Auflaufform auf Kombirost Verwende deine Lieblingsgewürze. Brate das Fleisch einige Minuten in einer heißen Pfanne.
P21	Hähnchenschenkel, frisch	-	 3; Backblech Wenn du die Hähnchenschenkel zuerst marinierst, stelle die niedrigere Temperatur ein und gare sie länger.
P22	Ente, ganz	2 - 3 kg	  2; Bräter auf Kombirost Verwende deine Lieblingsgewürze. Lege das Fleisch in den Bräter. Die Ente nach der Hälfte der Garzeit wenden.
P23	Gans, ganz	4 - 5 kg	  2; tiefe Pfanne Verwende deine Lieblingsgewürze. Lege das Fleisch auf das tiefe Backblech. Die Gans nach der Hälfte der Garzeit wenden.
P24	Hackbraten	1 kg	 2; Kombirost Verwende deine Lieblingsgewürze.

	Speise	Gewicht	Einschubebene / Zubehör
P25	Ganzer Fisch, gegrillt	0.5 - 1 kg pro Fisch	 2; Backblech Fisch mit Butter füllen und deine Lieblingsgewürze und Kräuter verwenden.
P26	Fischfilet	-	  3; Auflaufform auf Kombirost Verwende deine Lieblingsgewürze.
P27	Käsekuchen	-	 2;  28 cm Back-Springform auf Kombirost
P28	Apfelkuchen	-	 3; Backblech
P29	Apfelkuchen	-	 2; Kuchenform auf Kombirost
P30	Apfelkuchen	-	 1;  22 cmKuchenform auf Kombirost
P31	Brownies	2 kg Teig	 3; tiefe Pfanne
P32	Schokoladenmuffins	-	 3; Muffin-Blech auf Kombirost
P33	Brotkuchen	-	 2; Brotpfanne auf Kombirost
P34	Ofenkartoffeln	1 kg	 2; Backblech Die ganzen Kartoffeln mit der Schale auf das Backblech geben.
P35	Kartoffelspalten	1 kg	 3; Backblech mit Backpapier ausgekleidet Verwende deine Lieblingsgewürze. Kartoffeln in Stücke schneiden.
P36	Gemischtes Grillgemüse	1 - 1.5 kg	 3; Backblech mit Backpapier ausgekleidet Verwende deine Lieblingsgewürze. Gemüse in Stücke schneiden.
P37	Kroketten, gefroren	0.5 kg	 3; Backblech
P38	Pommes frites, gefroren	0.75 kg	 3; Backblech
P39	Fleisch- / Gemüselasagne mit trockenen Nudelblättern	1 - 1.5 kg	 2; Auflaufform auf Kombirost
P40	Kartoffelgratin (rohe Kartoffeln)	1 - 1.5 kg	 1; Auflaufform auf Kombirost Drehe das Gericht nach der Hälfte der Garzeit um.
P41	Pizza frisch, dünn	-	  2; Backblech mit Backpapier ausgekleidet
P42	Pizza frisch, dick	-	  2; Backblech mit Backpapier ausgekleidet
P43	Quiche	-	 2; Backform auf Kombirost





	Speise	Gewicht	Einschubebene / Zubehör
P44	Baguette / Ciabatta / Weißbrot	0.8 kg	 2; Backblech mit Backpapier ausgekleidet Für Weißbrot mehr Zeit nötig.
P45	Vollkorn- / Roggen- / dunkles Brot	1 kg	 2; Backblech mit Backpapier ausgekleidet / Kastenform auf Kombirost

7. UHRFUNKTIONEN

7.1 Uhrfunktionen

Uhrfunktion	Anwendung
 Kurzzeit-Wecker	Nach Ablauf der Zeit ertönt der Signalton.
 Garzeitdauer	Nach Ablauf des Timers ertönt ein akustisches Signal und die Ofenfunktion stoppt.
 Zeitvorwahl	Verzögerung des Starts und/oder des Endes des Kochens.
 Uptimer	Max. 23 Std. 59 Min. Diese Funktion wirkt sich nicht auf den Betrieb des Backofens aus. Um den Uptimer ein- oder auszuschalten, wähle: Menü, Einstellungen.

7.2 Einstellung: Uhrzeit

Einstellung: Uhrzeit		
Schritt 1	Schritt 2	Schritt 3
 		
Um die Uhrzeit zu ändern, rufen Sie das Menü auf und wählen Sie Einstellungen, Uhrzeit.	Stellen Sie die Uhrzeit ein.	Drücken Sie: OK .

Einstellung: Kurzzeit-Wecker

Schritt 1



Drücken Sie: .

Im Display wird Folgendes angezeigt:
0:00

Schritt 2



Stellen Sie Kurzzeit-Wecker ein.

Schritt 3



Drücken Sie: **OK**.

Der Countdown des Timers startet umgehend.

Einstellung: Garzeitdauer

Schritt 1



Wählen Sie eine Ofenfunktion und stellen Sie die Temperatur ein.

Schritt 2



Drücken Sie wiederholt: .

Im Display wird Folgendes angezeigt:
0:00

STOP

Schritt 3



Stellen Sie die Gar-dauer ein.

Schritt 4



Drücken Sie: **OK**.

Der Countdown des Timers startet umgehend.

Einstellung: Zeitvorwahl

Schritt 1



Wählen Sie die Ofenfunktion.

Schritt 2



Drücken Sie wiederholt: .

Das Display zeigt die Uhrzeit an.

START

Schritt 3



Stellen Sie die Startzeit ein.

Schritt 4



Drücken Sie: **OK**.

Im Display wird Folgendes angezeigt:
--:--
 STOPP

Schritt 5



Stellen Sie die Endzeit ein.

Schritt 6



Drücken Sie: **OK**.

Der Countdown des Timers beginnt zu der eingestellten Startzeit.

8. VERWENDUNG DES ZUBEHÖRS

WARNUNG!

Siehe Kapitel Sicherheitshinweise.

8.1 Einsetzen des Zubehörs

Die kleine Einkerbung auf der Oberseite erhöht die Sicherheit. Die Vertiefungen sind

auch Kippsicherungen. Durch den umlaufend erhöhten Rand des Rosts ist das Kochgeschirr gegen Abrutschen vom Rost gesichert.

Kombirost:

Schieben Sie den Rost zwischen die Führungsschienen der Einhängegitter.

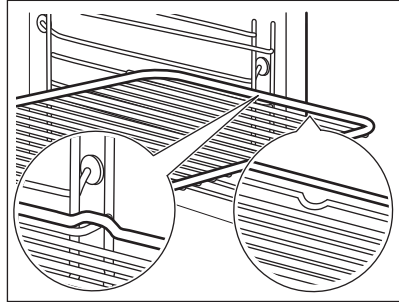
**Backblech / Auflauffanne:**

Schieben Sie das Backblech zwischen die Führungsstäbe der Einhängegitter.

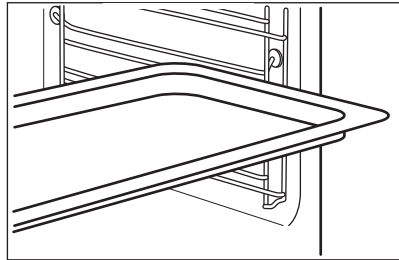

9. ZUSATZFUNKTIONEN

9.1 Verriegelung

Diese Funktion verhindert ein versehentliches Verstellen der Gerätefunktion.

Einschalten, wenn das Gerät in Betrieb ist – das eingestellte Garen wird fortgesetzt und das Bedienfeld ist verriegelt.

Schalten Sie sie ein, wenn das Gerät ausgeschaltet ist – sie kann nicht eingeschaltet werden, denn das Bedienfeld ist verriegelt.



– gedrückt halten, um die Funktion einzuschalten.
Ein Signal ertönt.







– gedrückt halten, um sie auszuschalten.

i 3 x  – blinkt, wenn die Verriegelung eingeschaltet ist.

9.2 Automatische Abschaltung

Aus Sicherheitsgründen schaltet sich das Gerät nach einer bestimmten Zeit automatisch aus, wenn die Ofenfunktion aktiv ist und keine Einstellungen geändert werden.

 (°C)	 (Std)
30 - 115	12.5
120 - 195	8.5
200 - 245	5.5

 (°C)	 (Std)
250 - max.	3

Die automatische Abschaltung funktioniert nicht mit den Funktionen:
Backofenbeleuchtung, Zeitvorwahl.

9.3 Kühlgebläse

Wenn das Gerät in Betrieb ist, schaltet sich das Kühlgebläse automatisch ein, um die Oberflächen des Geräts kühl zu halten. Nach dem Abschalten des Geräts kann das Kühlgebläse weiterlaufen, bis das Gerät abgekühlt ist.

10. TIPPS UND HINWEISE



10.1 Garempfehlungen



Die Temperaturen und Garzeiten in den Tabellen sind nur Richtwerte. Sie hängen von den Rezepten sowie der Qualität und Menge der verwendeten Zutaten ab.
Ihr Gerät backt oder brät unter Umständen anders als Ihr früheres Gerät. Die Hinweise unten enthalten die empfohlenen Einstellungen für Temperatur, Gardauer und Einschubebene für die einzelnen Speisen.
Finden Sie für ein bestimmtes Rezept keine konkreten Angaben, orientieren Sie sich an einem ähnlichem Rezept.

10.2 Feuchte Umluft

Beachte für beste Ergebnisse die unten in der Tabelle aufgeführten Empfehlungen.

	°C		
Nudelgratin	200 - 220	45 - 55	3
Kartoffelgratin	180 - 200	70 - 85	3
Moussaka	170 - 190	70 - 95	3
Lasagne, frisch	180 - 200	75 - 90	3
Cannelloni	180 - 200	70 - 85	3
Brotpudding	190 - 200	55 - 70	3
Milchreis	170 - 190	45 - 60	3
Apfelkuchen auf Rührteig (runde Kuchenform)	160 - 170	70 - 80	3
Weißbrot	190 - 200	55 - 70	3

10.3 Feuchte Umluft - Empfohlenes Zubehör

Verwenden Sie die dunklen und nicht reflektierenden Formen und Behälter. Sie haben eine bessere Wärmeabsorption als helle Farbe und reflektierende Schüsseln.

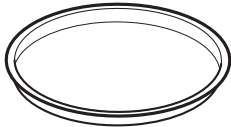

Pizzapfanne

Dunkel, nicht reflektierend
28 cm Durchmesser

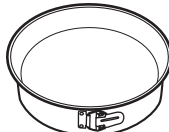

Backform

Dunkel, nicht reflektierend
26 cm Durchmesser



Förmchen

Keramikform
8 cm Durchmesser,
5 cm Höhe



Tortenbodenform





Dunkel, nicht reflektierend
28 cm Durchmesser

10.4 Gartabellen für Prüfinstitute

Informationen für Prüfinstitute





Tests gemäß: EN 60350, IEC 60350.

Backen auf einer Ebene – Backen in Backformen





		 °C	 Min	
Biskuit, fettfrei	Heißluft	160	45 - 60	2
Biskuit, fettfrei	Ober-/Unterhitze	160	45 - 60	2
Apfelkuchen, 2 Formen à Ø 20 cm	Heißluft	160	55 - 65	2
Apfelkuchen, 2 Formen à Ø 20 cm	Ober-/Unterhitze	180	55 - 65	1
Mürbeteiggebäck	Heißluft	140	25 - 35	2
Mürbeteiggebäck	Ober-/Unterhitze	140	25 - 35	2

Backen auf einer Ebene – Kekse

Nutzen Sie die dritte Einschubebene.

		 °C	 Min
Törtchen, 20 pro Blech, Heizen Sie den leeren Backofen vor	Heißluft	150	20 - 30
Törtchen, 20 pro Blech, Heizen Sie den leeren Backofen vor	Ober-/Unterhitze	170	20 - 30





Backen auf mehreren Ebenen – Kekse

		 °C	 Min	
Mürbeteiggebäck	Heißluft	140	25 - 45	2 / 4
Törtchen, 20 pro Blech, Heizen Sie den leeren Backofen vor	Heißluft	150	25 - 35	1 / 4
Biskuit, fettfrei	Heißluft	160	45 - 55	2 / 4
Apfelkuchen, 1 Backform pro Gitter (Ø 20 cm)	Heißluft	160	55 - 65	2 / 4

Grill

Heizen Sie den leeren Backofen 5 Minuten lang vor.

Grillen Sie bei maximaler Temperatureinstellung.

		 Min	
Toast	Grill	1 - 2	5
Rindersteak, Nach der Hälfte der Zeit wenden	Grill	24 - 30	4

11. REINIGUNG UND PFLEGE

WARNUNG!

Siehe Kapitel Sicherheitshinweise.

11.1 Hinweise zur Reinigung



Reinigungsmittel

Reinigen Sie die Vorderseite des Geräts nur mit einem Mikrofaser Tuch mit warmem Wasser und einem milden Reinigungsmittel.

Reinigen Sie die Metalloberflächen mit einer geeigneten Reinigungslösung.

Reinigen Sie Flecken mit einem milden Reinigungsmittel.



Täglicher Gebrauch

Reinigen Sie den Garraum nach jedem Gebrauch. Fettansammlungen oder andere Speisereste könnten einen Brand verursachen.

Lassen Sie die Speisen nicht länger als 20 Minuten im Gerät stehen. Trocknen Sie den Garraum nach jedem Gebrauch nur mit einem Mikrofaser Tuch ab.



Zubehör

Reinigen Sie alle Zubehörteile nach jedem Gebrauch und lassen Sie sie trocknen. Verwenden Sie nur ein Mikrofasertuch mit warmem Wasser und einem milden Reinigungsmittel. Reinigen Sie die Zubehörteile nicht im Geschirrspüler.

Reinigen Sie das Zubehör mit Antihafbeschichtung nicht mit Scheuermitteln oder scharfkantigen Gegenständen.

11.2 Entfernen: Einhängegitter

Entfernen Sie Eihängegitter zur Reinigung des Backofens.

Schritt 1 Schalten Sie den Backofen aus und warten Sie, bis er abgekühlt ist.

Schritt 2 Ziehen Sie das Eihängegitter vorne von der Seitenwand weg.

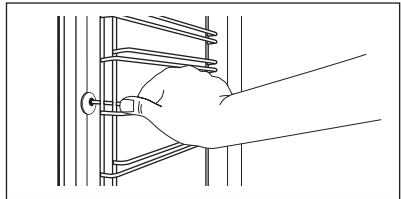

Schritt 3 Ziehen Sie das Eihängegitter hinten von der Seitenwand weg und nehmen Sie es heraus.

Schritt 4 Setze die Eihängegitter in umgekehrter Reihenfolge ein.

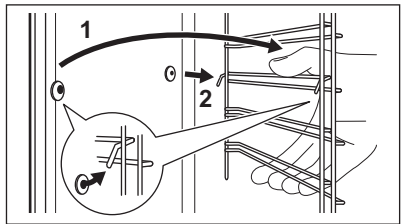

11.3 Benutzung: Pyrolytische Reinigung

Reinigen Sie den Backofen mit Pyrolytische Reinigung.

WARNUNG!

Es besteht das Risiko von Verbrennungen.

VORSICHT!

Befinden sich weitere Geräte in demselben Küchenmöbel, verwenden Sie diese nicht während dieser Funktion. Andernfalls kann der Backofen beschädigt werden.

Vor dem Pyrolytische Reinigung:

Schalten Sie den Backofen aus und warten Sie, bis er abgekühlt ist.

Entfernen Sie alle Zubehörteile aus dem Backofen und die herausnehmbaren Eihängegitter.

Reinigen Sie den Backofenboden und die innere Türglasscheibe mit warmem Wasser, einem weichen Tuch und einem milden Reinigungsmittel.

Pyrolytische Reinigung

Schritt 1

Menü eingeben: Reinigung  .

Option	Dauer
C1 - Leichte Reinigung	1 h
C2 - Normale Reinigung	1 h 30 min
C3 - Gründliche Reinigung	3 h

Schritt 2

 - drücken, um das Reinigungsprogramm auszuwählen.

Schritt 3

 - Drücken, um die Reinigung zu starten.

Schritt 4

Drehen Sie nach der Reinigung den Knopf für die Backofenfunktionen in die Aus-Position.

 Beim Start der Reinigung wird die Backofentür verriegelt und die Lampe ausgeschaltet. Bis die Tür entriegelt wird, zeigt das Display Folgendes an: .

Nach Abschluss der Reinigung:

Schalten Sie den Backofen aus und warten Sie, bis er abgekühlt ist.

Reinigen Sie den Garraum mit einem weichen Tuch.

Entfernen Sie die Rückstände vom Garraumboden.

11.4 Erinnerungsfunktion Reinigen

Der Backofen erinnert Sie daran, wann er mit der pyrolytischen Reinigung gereinigt werden muss.

 blinkt 5 Sekunden nach jedem Kochvorgang im Display.

Zum Ausschalten der Erinnerung geben Sie die Menü ein und wählen Sie Einstellungen, Erinnerungsfunktion Reinigen.

11.5 Aus- und Einbau: Tür

Sie können die Tür und inneren Glasscheiben zur Reinigung entfernen. Die Anzahl der Glasscheiben unterscheidet sich je nach Modell.

WARNUNG!

Die Tür ist schwer.

VORSICHT!

Behandeln Sie das Glas vorsichtig, insbesondere an den Kanten der vorderen Scheibe. Das Glas kann zerbrechen.

Schritt 1 Öffnen Sie die Tür vollständig.

Schritt 2 Heben Sie die Klemmhebel (A) an beiden Türscharnieren an und drücken Sie auf sie.

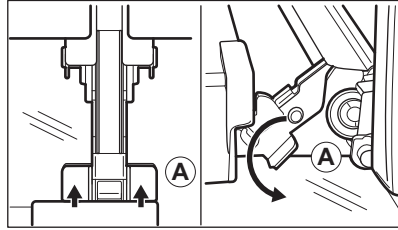

Schritt 3 Schließen Sie die Backofentür bis zur ersten Öffnungsstellung (in einem Winkel von ca. 70°). Fassen Sie die Tür mit beiden Händen seitlich an und ziehen Sie sie schräg nach oben vom Backofen weg. Legen Sie die Tür mit der Außenseite nach unten auf ein weiches Tuch und eine stabile Fläche.

Schritt 4 Fassen Sie die Türabdeckung (B) an der Oberkante der Tür an beiden Seiten an. Drücken Sie sie nach innen, um den Klippverschluss zu lösen.

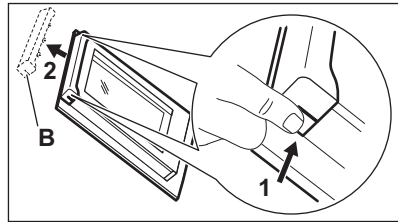

Schritt 5 Ziehen Sie die Türabdeckung nach vorn, um sie abzunehmen.

Schritt 6 Fassen Sie die Glasscheiben der Tür nacheinander am oberen Rand an und ziehen Sie sie nach oben aus den Führungen.

Schritt 7 Reinigen Sie die Glasscheibe mit Wasser und Spülmittel. Trocknen Sie die Glasscheibe sorgfältig ab. Reinigen Sie die Glasscheiben nicht im Geschirrspüler.

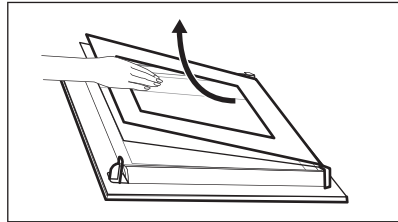

Schritt 8 Führen Sie nach der Reinigung die obigen Schritte in umgekehrter Reihenfolge durch.

Schritt 9 Setzen Sie zuerst die kleinere Scheibe ein, dann die größere Scheibe und die Tür.

11.6 Austausch: Lampe

⚠️ WARNUNG!

Stromschlaggefahr.
Die Lampe kann heiß sein.

Bevor Sie die Lampe austauschen:

Schritt 1

Schalten Sie den Backofen aus.
Warten Sie, bis der Ofen kalt ist.

Schritt 2

Trennen Sie den Ofen von der Netzversorgung.

Schritt 3

Breiten Sie ein Tuch auf dem Garraumboden aus.

Obere Lampe

Schritt 1 Drehen Sie die Glasabdeckung und nehmen Sie sie ab.

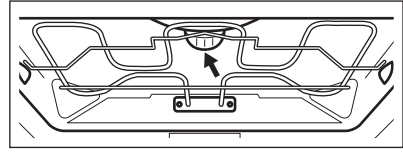

Schritt 2 Reinigen Sie die Glasabdeckung.

Schritt 3 Ersetzen Sie die Lampe durch eine geeignete, bis 300 °C hitzebeständige Lampe.

Schritt 4 Bringen Sie die Glasabdeckung an.

12. FEHLERSUCHE

WARNUNG!

Siehe Kapitel Sicherheitshinweise.

12.1 Was zu tun ist, wenn ...

In allen Fällen, die nicht in dieser Tabelle aufgeführt sind, wenden Sie sich bitte an einen autorisierten Kundendienst.



Das Gerät schaltet sich nicht ein oder heizt nicht auf

Störung	Prüfen Sie, ob Folgendes zutrifft ...
Das Gerät lässt sich nicht einschalten oder bedienen.	Das Gerät ist ordnungsgemäß an die Stromversorgung angeschlossen.
Das Gerät erwärmt sich nicht.	Die Abschaltautomatik ausgeschaltet.
Das Gerät erwärmt sich nicht.	Die Gerätetür ist geschlossen.
Das Gerät erwärmt sich nicht.	Die Sicherung ist nicht durchgebrannt.
Das Gerät erwärmt sich nicht.	Die Verriegelung ist nicht verschlossen.



Komponenten

Störung	Prüfen Sie, ob Folgendes zutrifft ...
Die Lampe ist ausgeschaltet.	Feuchte Umluft - ist eingeschaltet.
Die Lampe funktioniert nicht.	Die Lampe ist durchgebrannt.



Fehlercodes

Im Display erscheint ...	Prüfen Sie, ob Folgendes zutrifft ...
Err C3	Die Gerätetür ist geschlossen oder die Türverriegelung ist nicht beschädigt.
Err F102	Die Gerätetür ist geschlossen.
Err F102	Die Türverriegelung nicht defekt ist.
00:00	Es gab einen Stromausfall. Stellen Sie die Uhrzeit ein.

Wenn das Display einen Fehlercode anzeigt, der nicht in dieser Tabelle enthalten ist, schalten Sie die Haussicherung aus und wieder ein, um das Gerät neu zu starten. Wenn der Fehlercode erneut angezeigt wird, wenden Sie sich an einen autorisierten Kundendienst.

12.2 Service-Daten

Wenn Sie das Problem nicht selbst lösen können, wenden Sie sich an Ihren Händler oder einen autorisierten Kundendienst.

Die vom Kundendienst benötigten Daten finden Sie auf dem Typenschild. Das Typenschild befindet sich am vorderen Rahmen des Garraums des Geräts. Entfernen Sie das Typenschild nicht vom Garraum.

Wir empfehlen Ihnen, die Daten hier zu notieren:

Modell (MOD.):
Produktnummer (PNC)
Seriennummer (S.N.)

13. ENERGIEEFFIZIENZ

13.1 Produktinformation und Produktinformationsblatt gemäß den EU-Verordnungen zu Umweltdesign und Energiekennzeichnung

Name des Lieferanten	AEG
Modellbezeichnung	BPK535060B 944188596 BPK535060M 944188597
Energieeffizienzindex	81.2
Energieeffizienzklasse	A+
Energieverbrauch mit einer Standardbeladung, konventioneller Modus	1.09 kWh/Programm
Energieverbrauch mit einer Standardbeladung, Umluft-Modus	0.69 kWh/Programm
Anzahl der Garräume	1
Wärmequelle	Strom
Volumen	71 l
Art des Backofens	Eingebauter Backofen

Masse	BPK535060B	35.0 kg
	BPK535060M	35.0 kg

IEC/EN 60350-1 – Elektrische Kochgeräte für den Hausgebrauch – Teil 1: Herde, Backöfen, Dampföfen und Grills – Methoden zur Leistungsmessung.

13.2 Energiesparen



Das Gerät verfügt über Funktionen, mit deren Hilfe Sie beim täglichen Kochen Energie sparen können.

Stellen Sie sicher, dass die Gerätetür geschlossen ist, wenn das Gerät in Betrieb ist. Die Gerätetür darf während des Garvorgangs nicht zu oft geöffnet werden. Halten Sie die Türdichtung sauber und stellen Sie sicher, dass sie sich fest in der richtigen Position befindet.

Verwenden Sie Kochgeschirr aus Metall, um mehr Energie zu sparen.

Heizen Sie, wenn möglich, das Gerät vor dem Garvorgang nicht vor.

Wenn Sie mehrere Speisen gleichzeitig zubereiten, halten Sie die Unterbrechungen beim Backen so kurz wie möglich.

Garen mit Heißluft

Nutzen Sie, wenn möglich, die Garfunktionen mit Heißluft, um Energie zu sparen.

Restwärme

Ventilator und Lampe funktionieren weiter. Sobald Sie das Gerät ausschalten, wird im Display die Restwärme angezeigt. Die Restwärme kann zum Warmhalten von Speisen genutzt werden.

Beträgt die Garzeit mehr als 30 Minuten, reduzieren Sie die Gerätetemperatur mindestens 3 - 10 Min. vor Ablauf des Garvorgangs. Durch die Restwärme im Gerät wird der Garvorgang fortgesetzt.

Nutzen Sie die Restwärme, um andere Speisen aufzuwärmen.

Warmhalten von Speisen

Wählen Sie die niedrigste Temperatureinstellung, wenn Sie die Restwärme zum Warmhalten von Speisen nutzen möchten. Die Restwärmeanzeige oder Temperatur werden auf dem Display angezeigt.

Garen bei ausgeschalteter

Backofenbeleuchtung

Schalten Sie die Lampe während des Garvorgangs aus. Schalten Sie sie nur ein, wenn Sie sie benötigen.

Feuchte Umluft

Diese Funktion soll während des Garvorgangs Energie sparen.

Bei Verwendung dieser Funktion schaltet sich die Lampe automatisch nach 30 Sekunden aus. Sie können die Lampe wieder einschalten, aber dadurch werden die erwarteten Energieeinsparungen reduziert.

14. MENÜSTRUKTUR

14.1 Menü

Schritt 1	Schritt 2	Schritt 3	Schritt 4	Schritt 5
-----------	-----------	-----------	-----------	-----------



 - Wählen Sie, um die Menü einzugeben.

Wählen Sie die Option aus der Menü Struktur aus und drücken Sie **OK**.

Wählen Sie die Einstellung.

OK – drücken, um die Einstellung zu bestätigen.

Stellen Sie den Wert ein und drücken Sie **OK**.

Drehen Sie den Knopf für die Ofenfunktionen in die Aus-Position, um Menü zu verlassen.

Menü Struktur

Koch-Assistent 

Reinigung 

Einstellungen 

Einstellungen

01	Uhrzeit	Ändern	02	Helligkeit	1 - 5
03	Tastentöne	1 - Signalton 2 - Klicken 3 - Ton aus	04	Lautstärke	1 - 4
05	Uptimer	Ein / Aus	06	Backofenbeleuchtung	Ein / Aus
07	Schnellaufheizung	Ein / Aus	08	Erinnerungsfunktion Reinigen	Ein / Aus
09	DEMO	Aktivierungscode: 2468	10	Softwareversion	Prüfen
11	Gerät auf Werkseinstellungen zurücksetzen	Ja / Nein			

15. INFORMATIONEN ZUR ENTSORGUNG

Ihre Pflichten als Endnutzer



Dieses Elektro- bzw. Elektronikgerät ist mit einer durchgestrichenen Abfalltonne auf Rädern gekennzeichnet. Das Gerät darf deshalb nur getrennt vom unsortierten Siedlungsabfall gesammelt und zurückgenommen werden, es darf also nicht in den Hausmüll gegeben werden. Das Gerät

kann z. B. bei einer kommunalen Sammelstelle oder ggf. bei einem Vertreiber (siehe zu deren Rücknahmepflichten unten) abgegeben werden. Das gilt auch für alle Bauteile, Unterbaugruppen und Verbrauchsmaterialien des zu entsorgenden Altgeräts.

Bevor das Altgerät entsorgt werden darf, müssen alle Altbatterien und Altakkumulatoren vom Altgerät getrennt werden, die nicht vom Altgerät umschlossen sind. Das gleiche gilt für Lampen, die zerstörungsfrei aus dem Altgerät entnommen werden können. Der Endnutzer ist zudem selbst dafür verantwortlich, personenbezogene Daten auf dem Altgerät zu löschen.

Hinweise zum Recycling

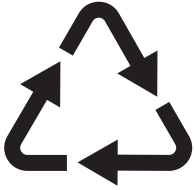

Helfen Sie mit, alle Materialien zu recyceln, die mit diesem Symbol gekennzeichnet sind. Entsorgen Sie solche Materialien, insbesondere Verpackungen, nicht im Hausmüll sondern über die bereitgestellten Recyclingbehälter oder die entsprechenden örtlichen Sammelsysteme.

Recyceln Sie zum Umwelt- und Gesundheitsschutz auch elektrische und elektronische Geräte.

Rücknahmepflichten der Verreiber in Deutschland

Wer auf mindestens 400 m² Verkaufsfläche Elektro- und Elektronikgeräte vertreibt oder sonst geschäftlich an Endnutzer abgibt, ist verpflichtet, bei Abgabe eines neuen Geräts ein Altgerät des Endnutzers der gleichen Geräteart, das im Wesentlichen die gleichen Funktionen wie das neue Gerät erfüllt, am Ort der Abgabe oder in unmittelbarer Nähe hierzu unentgeltlich zurückzunehmen. Das gilt auch für Verreiber von Lebensmitteln mit einer Gesamtverkaufsfläche von mindestens 800 m², die mehrmals im Kalenderjahr oder dauerhaft Elektro- und Elektronikgeräte anbieten und auf dem Markt bereitstellen. Solche Verreiber müssen zudem auf Verlangen des Endnutzers Altgeräte, die in keiner äußeren Abmessung größer als 25 cm sind (kleine Elektrogeräte), im Einzelhandelsgeschäft oder in unmittelbarer Nähe hierzu unentgeltlich zurückzunehmen; die Rücknahme darf in diesem Fall nicht an den Kauf eines Elektro- oder Elektronikgerätes geknüpft, kann aber auf drei Altgeräte pro Geräteart beschränkt werden.

Ort der Abgabe ist auch der private Haushalt, wenn das neue Elektro- oder Elektronikgerät dorthin geliefert wird; in diesem Fall ist die Abholung des Altgerätes für den Endnutzer kostenlos.

Die vorstehenden Pflichten gelten auch für den Vertrieb unter Verwendung von Fernkommunikationsmitteln, wenn die Verreiber Lager- und Versandflächen für Elektro- und Elektronikgeräte bzw. Gesamtlager- und -versandflächen für Lebensmittel vorhalten, die den oben genannten Verkaufsflächen entsprechen. Die unentgeltliche Abholung von Elektro- und Elektronikgeräten ist dann aber auf Wärmeüberträger (z. B. Kühlschrank), Bildschirme, Monitore und Geräte, die Bildschirme mit einer Oberfläche von mehr als 100 cm² enthalten, und Geräte beschränkt, bei denen mindestens eine der äußeren Abmessungen mehr als 50 cm beträgt. Für alle übrigen Elektro- und Elektronikgeräte muss der Verreiber geeignete Rückgabemöglichkeiten in zumutbarer Entfernung zum jeweiligen Endnutzer gewährleisten; das gilt auch für kleine Elektrogeräte (s.o.), die der Endnutzer zurückgeben will, ohne ein neues Gerät zu kaufen.

Rücknahmepflichten von Verreibern und andere Möglichkeiten der Entsorgung von Elektro- und Elektronikgeräten in der Region Wallonien

Verreiber, die Elektro- und Elektronikgeräte verkaufen, sind verpflichtet, bei der Lieferung von Neugeräten Altgeräte desselben Typs, die im Wesentlichen die gleichen Funktionen wie die Neugeräte erfüllen, kostenlos vom Endverbraucher zurückzunehmen. Dies gilt auch bei der Lieferung von neuen Elektro- und Elektronikgeräten oder beim Fernabsatz.

Darüber hinaus ist jeder, der Elektro- und Elektronikgeräte auf einer Verkaufsfläche von mindestens 400 m² verkauft, verpflichtet, Altgeräte, die in keiner äußeren Abmessung größer als 25 cm sind (Elektrokleingeräte), im Ladengeschäft oder in unmittelbarer Nähe kostenlos zurückzunehmen; die Rücknahme darf in diesem Fall nicht vom Kauf eines Elektro- oder Elektronikgerätes abhängig gemacht werden.

Die Rücknahme von Elektro- und Elektronikgeräten kann auch auf Containerplätzen oder zugelassenen Recyclinghöfen erfolgen. Für weitere Informationen wenden Sie sich bitte an Ihre Gemeindeverwaltung.

Benvenuto in AEG! Grazie per aver scelto di acquistare questo prodotto.



Ricevere consigli per l'uso, scaricare i nostri opuscoli, eliminare eventuali anomalie, ottenere informazioni sull'assistenza e la riparazione su: aeg.com/support



Per ulteriori ricette, suggerimenti, indicazioni per la risoluzione dei problemi scaricare l'app **My AEG Kitchen**.



Con riserva di modifiche.

INDICE

1. INFORMAZIONI DI SICUREZZA.....	132
2. ISTRUZIONI DI SICUREZZA.....	134
3. DESCRIZIONE DEL PRODOTTO.....	138
4. PANNELLO DEI COMANDI.....	138
5. PRIMA DEL PRIMO UTILIZZO.....	139
6. UTILIZZO QUOTIDIANO.....	140
7. FUNZIONI DEL TIMER.....	145
8. UTILIZZO DEGLI ACCESSORI.....	146
9. FUNZIONI AGGIUNTIVE.....	147
10. CONSIGLI E SUGGERIMENTI UTILI.....	148
11. PULIZIA E CURA.....	150
12. RISOLUZIONE DEI PROBLEMI.....	154
13. EFFICIENZA ENERGETICA.....	155
14. STRUTTURA DEL MENU.....	156
15. CONSIDERAZIONI SULL'AMBIENTE.....	157

1. ⚠ INFORMAZIONI DI SICUREZZA

Leggere attentamente le istruzioni fornite prima di installare e utilizzare l'apparecchiatura. I produttori non sono responsabili di eventuali lesioni o danni derivanti da un'installazione o un uso scorretti. Conservare sempre le istruzioni in un luogo sicuro e accessibile per poterle consultare in futuro.

1.1 Sicurezza di bambini e persone vulnerabili

- Quest'apparecchiatura può essere usata da bambini a partire da 8 anni di età e da adulti con capacità fisiche, sensoriali o mentali limitate o con scarsa esperienza e conoscenza sull'uso dell'apparecchiatura, solamente se

sorvegliati o se istruiti relativamente all'utilizzo in sicurezza dell'apparecchiatura e se hanno compreso i rischi coinvolti. I bambini che hanno meno di 8 anni e le persone con disabilità diffuse e complesse vanno tenuti lontani dall'elettrodomestico, a meno che non vi sia una supervisione continua.

- I bambini devono essere sorvegliati per assicurarsi che non giochino con l'apparecchiatura.
- Tenere gli imballaggi lontano dai bambini e smaltirli in modo adeguato.
- **AVVERTENZA:** L'elettrodomestico e le parti accessibili si riscaldano molto durante l'uso. Tenere i bambini e gli animali domestici lontani dall'apparecchiatura durante l'uso e durante il raffreddamento.
- Se l'elettrodomestico ha un dispositivo di sicurezza per i bambini sarà opportuno attivarlo.
- I bambini non devono eseguire interventi di pulizia e manutenzione sull'elettrodomestico senza essere supervisionati.

1.2 Avvertenze di sicurezza generali

- L'apparecchiatura è destinata solo alla cottura.
- Quest'apparecchiatura è progettata per un uso domestico singolo in un ambiente interno.
- Quest'apparecchiatura può essere utilizzata in uffici, camere d'albergo, camere di bed & breakfast, alloggi in agriturismi e altre sistemazioni simili in cui tale utilizzo non superi i livelli di utilizzo domestico (medi).
- L'installazione dell'apparecchiatura e la sostituzione dei cavideve essere effettuata unicamente da personale qualificato.
- Non utilizzare l'apparecchiatura prima di installarla nella struttura a incasso.
- Prima di ogni operazione di manutenzione, scollegare l'apparecchiatura dall'alimentazione elettrica.

- Se il cavo di alimentazione è danneggiato, deve essere sostituito dal produttore, da un centro di assistenza tecnica autorizzato o da una persona qualificata per evitare situazioni di pericolo elettrico.
- **AVVERTENZA:** Assicurarsi che l'elettrodomestico sia spento prima di sostituire la lampadina per evitare la possibilità di scosse elettriche.
- **AVVERTENZA:** L'elettrodomestico e le parti accessibili si riscaldano molto durante l'uso. Prestare attenzione a non toccare le resistenze o la superficie della cavità dell'apparecchiatura.
- Utilizzare sempre guanti da forno per rimuovere o inserire accessori o pirofile.
- Per rimuovere i supporti del ripiano, tirare prima la parte anteriore del supporto del ripiano e poi l'estremità posteriore lontano dalle pareti laterali. Installare i supporti ripiani seguendo al contrario la procedura indicata.
- Non utilizzare vaporelle per pulire l'elettrodomestico.
- Non utilizzare detergenti abrasivi o raschietti di metallo per pulire il vetro dello sportello per non rigare la superficie e causare la rottura del vetro.
- Prima della pulizia per pirolisi rimuovere gli accessori e i depositi/le fuoriuscite eccessivi dalla cavità dell'apparecchiatura.

2. ISTRUZIONI DI SICUREZZA

2.1 Installazione

AVVERTENZA!

L'installazione dell'apparecchiatura deve essere eseguita da personale qualificato.

- Rimuovere tutti i materiali di imballaggio.
- Non installare o utilizzare l'apparecchiatura se è danneggiata.
- Attenersi alle istruzioni fornite insieme all'apparecchiatura.
- Prestare sempre attenzione in fase di spostamento dell'apparecchiatura, dato

che è pesante. Usare sempre i guanti di sicurezza e le calzature adeguate.

- Non tirare l'apparecchiatura per la maniglia.
- Installare l'apparecchiatura in un luogo sicuro e idoneo che soddisfi i requisiti di installazione.
- È necessario rispettare la distanza minima dalle altre apparecchiature.
- Prima di montare l'apparecchiatura controllare che la porta dell'apparecchio si apra senza limitazioni.

- L'apparecchiatura è dotata di un sistema di raffreddamento elettrico. Quest'ultimo funziona a corrente elettrica.
- L'unità a incasso deve soddisfare i requisiti di stabilità DIN 68930.

Altezza minima del mobiletto (mobiletto sotto all'altezza minima del piano di lavoro)	578 (600) mm
Larghezza del mobiletto	560 mm
Profondità del mobiletto	550 (550) mm
Altezza della parte anteriore dell'apparecchiatura	594 mm
Altezza della parte posteriore dell'apparecchiatura	576 mm
Larghezza della parte anteriore dell'apparecchiatura	595 mm
Larghezza della parte posteriore dell'apparecchiatura	559 mm
Profondità dell'apparecchiatura	567 mm
Profondità di incasso dell'apparecchiatura	546 mm
Profondità con porta aperta	1027 mm
Dimensioni minime dell'apertura di ventilazione. Apertura collocata sul lato posteriore inferiore	560x20 mm
Lunghezza del cavo di alimentazione. Il cavo è collocato nell'angolo destro del lato posteriore	1500 mm
Viti di montaggio	4x25 mm

2.2 Collegamento elettrico



AVVERTENZA!

Rischio di incendio e scossa elettrica.

- Tutti i collegamenti elettrici devono essere realizzati da un elettricista qualificato.
- L'apparecchiatura deve disporre di una messa a terra.
- Verificare che i parametri sulla targhetta siano compatibili con le indicazioni elettriche dell'alimentazione.

- Utilizzare sempre una presa elettrica con contatto di protezione correttamente installata.
- Non utilizzare prese multiple e prolunghe.
- Accertarsi di non danneggiare la spina e il cavo. Qualora il cavo elettrico debba essere sostituito, l'intervento dovrà essere effettuato dal nostro Centro di Assistenza autorizzato.
- Evitare che i cavi entrino a contatto o si trovino vicino alla porta dell'apparecchiatura o sulla nicchia sotto all'apparecchiatura, in particolare quando il dispositivo è in funzione o la porta è calda.
- I dispositivi di protezione da scosse elettriche devono essere fissati in modo tale da non poter essere disattivati senza l'uso di attrezzi.
- Inserire la spina di alimentazione nella presa solo al termine dell'installazione. Verificare che la spina di alimentazione rimanga accessibile dopo l'installazione.
- Nel caso in cui la spina di corrente sia allentata, non collegarla alla presa.
- Non tirare il cavo di alimentazione per scollegare l'apparecchiatura. Tirare sempre dalla spina.
- Servirsi unicamente di dispositivi di isolamento adeguati: interruttori automatici, fusibili (quelli a tappo devono essere rimossi dal portafusibile), sganciatori per correnti di guasto a terra e relè.
- L'impianto elettrico deve essere dotato di un dispositivo di isolamento che consenta di scollegare l'apparecchiatura dalla presa di corrente a tutti i poli. Il dispositivo di isolamento deve avere una larghezza dell'apertura di contatto non inferiore ai 3 mm.
- Chiudere completamente la porta dell'apparecchiatura prima di collegare spina alla presa elettrica.
- La dotazione standard dell'apparecchiatura al momento della fornitura prevede una spina e un cavo di rete.

2.3 Utilizzo:

AVVERTENZA!

Rischio di lesioni, ustioni, scosse elettriche o esplosioni.

- Non modificare le specifiche tecniche dell'apparecchiatura.
- Assicurarsi che le aperture di ventilazione non siano bloccate.
- Non lasciare l'elettrodomestico incustodito durante il funzionamento.
- Spegnerlo l'elettrodomestico dopo ogni utilizzo.
- Prestare attenzione in fase di apertura dello sportello dell'elettrodomestico, quando quest'ultimo è in funzione. Può esservi un rilascio di aria calda.
- Non accendere l'elettrodomestico con le mani bagnate o quando è a contatto con l'acqua.
- Non esercitare pressione sullo sportello aperto.
- Non utilizzare l'elettrodomestico come superficie di lavoro o come superficie di deposito.
- Aprire lo sportello dell'elettrodomestico attentamente. L'utilizzo di ingredienti con alcol può provocare una miscela di alcol e aria.
- Non lasciare scintille o fiamme libere a contatto con l'elettrodomestico quando si apre lo sportello.
- Non appoggiare o tenere liquidi o materiali infiammabili, né oggetti facilmente infiammabili sull'apparecchiatura, al suo interno o nelle immediate vicinanze.

AVVERTENZA!

Vi è il rischio di danneggiare l'apparecchiatura.

- Per evitare danni o lo scolorimento dello smalto:
 - Non collocare pirofile o altri oggetti all'interno dell'elettrodomestico direttamente sul fondo.
 - Non collocare la pellicola di alluminio direttamente sul fondo della cavità dell'elettrodomestico.
 - Non versare acqua direttamente all'interno dell'elettrodomestico caldo.

- Non conservare piatti e alimenti umidi all'interno dell'elettrodomestico dopo aver terminato la cottura.
- Prestare attenzione in fase di rimozione o installazione degli accessori.

- Lo scolorimento dello smalto o dell'acciaio inox non influisce sulle prestazioni dell'elettrodomestico.
- Usare una leccarda per torte umide. I succhi di frutta causano macchie che possono essere permanenti.
- Eseguire sempre la cottura con lo sportello dell'apparecchiatura chiuso.
- Se l'apparecchiatura si trova dietro a un pannello anteriore (ad es. una porta), assicurarsi che questo non sia mai chiuso quando l'apparecchiatura è in funzione. Calore e umidità possono accumularsi sul retro di un pannello chiuso causando danni all'apparecchiatura, all'alloggiamento o al pavimento. Dopo l'uso non chiudere il pannello dell'armadio finché l'apparecchiatura non si è completamente raffreddata.

2.4 Pulizia e cura

AVVERTENZA!

Rischio di lesioni, di incendio o di danni all'apparecchiatura.

- Prima di eseguire qualunque intervento di manutenzione, spegnere l'apparecchiatura ed estrarre la spina dalla presa.
- Controllare che l'apparecchiatura sia fredda. Vi è il rischio che i pannelli in vetro si rompano.
- Sostituire immediatamente i pannelli in vetro della porta nel caso in cui siano danneggiati. Contattare il Centro Assistenza Autorizzato.
- Prestare attenzione quando si rimuove la porta dall'apparecchio. La porta è pesante!
- Pulire regolarmente l'elettrodomestico per evitare il deterioramento dei materiali che compongono la superficie.
- Pulire l'apparecchiatura con un panno inumidito e morbido. Utilizzare solo detersivi neutri. Non usare prodotti abrasivi, spugnette abrasive, solventi od oggetti metallici.

- Se si utilizza uno spray per il forno, seguire attentamente le istruzioni di sicurezza sulla confezione.

2.5 Pulizia per pirolisi

AVVERTENZA!

Rischio di lesioni/Incendi/Emissioni chimiche (Fumi) in Modalità Pirolitica.

- Prima di eseguire la pulizia per pirolisi e il preriscaldamento iniziale, rimuovere dalla cavità del forno:
 - eventuali residui di cibo in eccesso, perdite di olio o grasso/versamenti
 - eventuali oggetti rimovibili (compresi ripiani, guide laterali, ecc., forniti con l'apparecchiatura), in particolare pentole antiaderenti, gastronom, lamiere dolci, utensili antiaderenti, ecc.
- Leggere attentamente tutte le istruzioni per la pulizia per pirolisi.
- Tenere i bambini lontano dall'elettrodomestico mentre è in corso la pulizia per pirolisi. L'apparecchiatura diventa molto calda e viene rilasciata aria calda dalle aperture di raffreddamento anteriori.
- La pulizia per pirolisi è un'operazione ad alta temperatura che può rilasciare vapori di residui di cottura e materiali strutturali, pertanto i consumatori sono invitati ad:
 - assicurare una buona ventilazione durante e dopo la pulizia per pirolisi.
 - fornire una buona ventilazione durante e dopo il preriscaldamento iniziale.
- Non versare o applicare acqua sulla porta del forno durante e dopo la pulizia per pirolisi per evitare di danneggiare i pannelli in vetro.
- I vapori rilasciati da tutti i forni pirolitici/residui di cottura vengono definiti come non nocivi per la salute umana, compresi bambini o persone affette da malattie.
- Tenere gli animali domestici lontani dall'elettrodomestico durante e dopo la pulizia per pirolisi e il preriscaldamento iniziale. I piccoli animali domestici (soprattutto uccelli e rettili) possono essere altamente sensibili alle variazioni di temperatura e ai fumi emessi.
- Superfici antiaderenti su pentole, padelle, teglie, utensili, ecc., possono essere

danneggiate dalla temperatura elevata della pulizia per pirolisi di tutti i forni pirolitici e possono essere anche una fonte di vapori nocivi a basso livello.

2.6 Illuminazione interna

AVVERTENZA!

Pericolo di scossa elettrica.

- Per quanto riguarda la lampada o le lampade all'interno di questo prodotto e le lampade di ricambio vendute separatamente: Queste lampade sono destinate a resistere a condizioni fisiche estreme negli elettrodomestici, come temperatura, vibrazioni, umidità, o sono destinate a segnalare informazioni sullo stato operativo dell'apparecchio. Non sono destinate ad essere utilizzate in altre applicazioni e non sono adatte per l'illuminazione di ambienti domestici.
- Questo prodotto contiene una sorgente luminosa di classe di efficienza energetica G.
- Servirsi unicamente di lampadine con le stesse specifiche tecniche .

2.7 Assistenza

- Per far riparare l'apparecchiatura, rivolgersi a un Centro di Assistenza Autorizzato.
- Utilizzare solo ricambi originali.

2.8 Smaltimento

AVVERTENZA!

Rischio di lesioni o soffocamento.

- Contattare le autorità locali per ricevere informazioni su come smaltire correttamente l'apparecchiatura.
- Staccare la spina dall'alimentazione elettrica.
- Tagliare il cavo elettrico dell'apparecchiatura e smaltirlo.
- Togliere il blocco porta per evitare che bambini, o animali restino intrappolati nell'apparecchiatura.

3. DESCRIZIONE DEL PRODOTTO

3.1 Panoramica generale

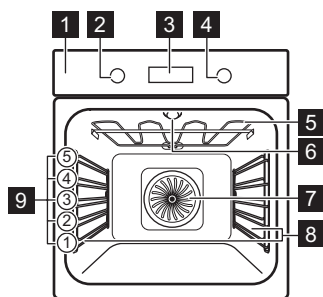

- 1 Pannello dei comandi
- 2 Manopola di regolazione delle funzioni cottura
- 3 Display
- 4 Manopola di regolazione
- 5 Resistenza
- 6 Lampadina
- 7 Ventola
- 8 Supporto ripiano, rimovibile
- 9 Posizioni ripiano

3.2 Accessori

Ripiano a filo

Per stoviglie, stampi per dolci, arrostiti.

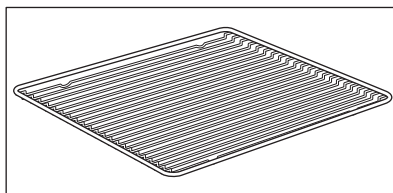

Lamiera dolci

Per torte e biscotti.

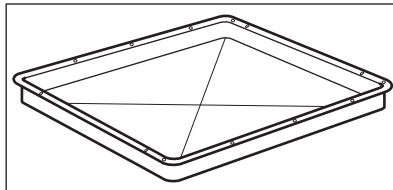

Leccarda

Per cuocere al forno e arrostiti o per raccogliere il grasso.

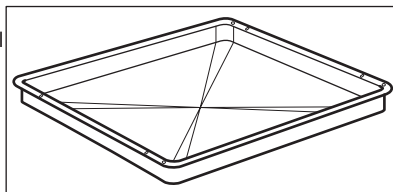

4. PANNELLO DEI COMANDI





4.1 Manopola incassabile

Per utilizzare l'apparecchiatura, premere la manopola. La manopola fuoriesce.

4.2 Panoramica del pannello di controllo

Selezionare una funzione cottura per accendere l'elettrodomestico. Per spegnere

l'elettrodomestico, ruotare la manopola delle funzioni cottura fino a portarla in posizione off.

				OK
Timer	Riscaldamento rapido	Luce forno	Blocco	Confermare l'impostazione



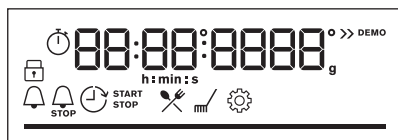

4.3 Display







Display con le funzioni chiave.

Spie display

Indicatori di base

				
Blocco	Cottura guidata	Pulizia	Impostazioni	Riscaldamento rapido

Spie timer

			
Contaminuti	Orario fine	Ritardo	Timer

Barra di avanzamento - per temperatura o tempo. Quando l'elettrodomestico raggiunge la temperatura impostata, la barra è completamente rossa.



5. PRIMA DEL PRIMO UTILIZZO

AVVERTENZA!

Fare riferimento ai capitoli sulla sicurezza.

5.1 Pulizia iniziale

Prima del primo utilizzo, pulire l'elettrodomestico vuoto e impostare l'ora:



00:00

Impostare l'ora. Premere **OK**.

5.2 Preriscaldamento iniziale

Preriscaldare il forno vuoto prima di utilizzarlo per la prima volta.

Passaggio 1 Rimuovere gli accessori e i supporti ripiano rimovibili dal forno.

Passaggio 2 Impostare la temperatura massima per la funzione: .
Lasciare in funzione il forno per 1 h.

Passaggio 3 Impostare la temperatura massima per la funzione: .
Lasciare in funzione il forno per 15 min.

 Il forno può produrre un odore sgradevole e fumo in fase di preriscaldamento. Accertarsi che la stanza sia ventilata.

6. UTILIZZO QUOTIDIANO

AVVERTENZA!

Fare riferimento ai capitoli sulla sicurezza.

6.1 Come impostare le Funzioni cottura

Passaggio 1 Ruotare la manopola delle funzioni cottura per selezionare una funzione cottura.

Passaggio 2 Ruotare la manopola di regolazione della temperatura per impostare la temperatura.

6.2 Funzioni cottura









Funzione cottura

Applicazione



Cottura ventilata

Per cuocere su tre posizioni della griglia contemporaneamente ed essiccare i cibi. Impostare la temperatura del forno di 20 – 40°C in meno rispetto a Cottura convenzionale.

Funzione cottura	Applicazione
 Cottura convenzionale	Per cuocere e arrostitire alimenti su una sola posizione della griglia.
 Cibi congelati	Per rendere croccanti i cibi confezionati, come ad esempio patatine fritte, crocchette o involtini primavera.
 Funzione Pizza	Per cuocere la pizza. Per una doratura intensa e una base croccante.
 Resistenza inferiore	Per dorare torte con base croccante e per conservare gli alimenti.
 Scongelamento	Per scongelare gli alimenti (verdura e frutta). Il tempo di scongelamento dipende dalla quantità e dalle dimensioni del cibo congelato.
 Cottura ventilata umida	Questa funzione è progettata per risparmiare energia durante la cottura. Quando utilizzi questa funzione, la temperatura all'interno dell'apparecchiatura può differire dalla temperatura impostata. Viene utilizzato il calore residuo. La potenza di riscaldamento può essere ridotta. Per ulteriori informazioni, rimandiamo al capitolo "Utilizzo quotidiano", Note su: Cottura ventilata umida.
 Grill	Per grigliare alimenti di ridotto spessore e tostare il pane.
 Doppio grill ventilato	Per arrostitire grandi tagli di carne o pollame con ossa su una posizione della griglia. Per gratinare e dorare.
 Menu	Per accedere al Menu: Cottura guidata, Pulizia, Impostazioni.

6.3 Note su: Cottura ventilata umida

Questa funzione è stata utilizzata per la conformità alla classe energetica e ai requisiti di ecodesign (secondo la normativa EU 65/2014 e EU 66/2014). Test conformemente a: IEC/EN 60350-1.

La porta del forno dovrebbe essere chiusa in fase di cottura, in modo che la funzione non venga interrotta. Ciò garantisce inoltre che il forno funzioni con la più elevata efficienza energetica possibile.

Quando viene usata questa funzione, la lampada si spegne automaticamente dopo 30 secondi.

Per le istruzioni di cottura rimandiamo al capitolo "Consigli e suggerimenti", Cottura ventilata umida. Per indicazioni generali sul risparmio energetico rimandiamo al capitolo "Efficienza energetica", Risparmio energetico.







6.4 Come impostare: Cottura guidata

Ogni piatto di questo sottomenu prevede una funzione cottura e una temperatura consigliate. Utilizzare la funzione per preparare un piatto rapidamente con le impostazioni predefinite. È anche possibile regolare l'ora e la temperatura in fase di cottura.

Al termine della funzione, controllare se il cibo è pronto.

Alcune pietanze possono anche essere cucinate usando:

• Peso automatico

Passaggio 1	Passaggio 2	Passaggio 3	Passaggio 4
 	 	 P1 - P...	 OK
Accedere al menu.	Selezionare Cottura guidata. Premere OK .	Selezionare la pietanza. Premere OK .	Inserire la pietanza nel forno. Confermare l'impostazione.

6.5 Cottura guidata

Legenda



Peso automatico disponibile.







Legenda















































Preriscaldare l'apparecchiatura prima di iniziare la cottura.





Livello del ripiano.

Piatto	Peso	Livello / Accessorio ripiano
P1 Roast beef, al sangue		
P2 Roast beef, cottura media	1 - 1.5 kg; 4 - 5 pezzi cm spessi	 2 lamiera dolci Friggere la carne per alcuni minuti in una padella calda. Inserire nell'apparecchiatura.
P3 Roast beef, ben cotto		
P4 Bistecca, media cottura	180 - 220 g per pezzo; 3 fette cm spesse	  3; pirofila su ripiano a filo Friggere la carne per alcuni minuti in una padella calda. Inserire nell'apparecchiatura.
P5 Arrosto di manzo / brasato (costoletta, scamone, fesa)	1.5 - 2 kg	  2; pirofila su ripiano a filo Friggere la carne per alcuni minuti in una padella calda. Aggiungere liquido. Inserire nell'apparecchiatura.
P6 Roast beef, al sangue (cottura lenta)		
P7 Roast beef, cottura media (cottura lenta)	1 - 1.5 kg; 4 - 5 pezzi cm spessi	 2; lamiera dolci Utilizzare le spezie preferite o il semplice pepe macinato. Friggere la carne per alcuni minuti in una padella calda. Inserire nell'apparecchiatura.
P8 Roast beef, ben cotto (cottura lenta)		





	Piatto	Peso	Livello / Accessorio ripiano
P9	Filetto di manzo, al sangue (cottura lenta)		
P10	Filetto di manzo, cott. media (cottura lenta)	0,5 - 1,5 kg; 5 - 6 pezzi cm spessi	 2 lamiera dolci Utilizzare le spezie preferite o il semplice pepe macinato. Friggere la carne per alcuni minuti in una padella calda. Inserire nell'apparecchiatura.
P11	Filetto di manzo, ben cotto (cottura lenta)		
P12	Arrosto di vitello (ad es. spalla)	0,8 - 1,5 kg; 4 pezzi cm spessi	  2; pirofila su ripiano a filo Utilizzare le spezie preferite. Aggiungere liquido. Arrosto coperto.
P13	Collo o spalla di maiale arrosto	1,5 - 2 kg	  2; pirofila su ripiano a filo Girare la carne a metà cottura.
P14	Maiale sfilacciato (cottura lenta)	1,5 - 2 kg	 2 lamiera dolci Utilizzare le spezie preferite. Girare la carne a metà cottura per ottenere una doratura uniforme.
P15	Lombo di maiale, fresco	1 - 1,5 kg; 5 - 6 pezzi cm spessi	 2; pirofila su ripiano a filo Utilizzare le spezie preferite.
P16	Costolette di maiale	2 - 3 kg; utilizzare crudo, 2 - 3 cm costolette di maiale sottili	 3; leccarda Aggiungere il liquido per coprire il fondo di un piatto. Girare la carne a metà cottura.
P17	Cosciotto d'agnello con ossa	1,5 - 2 kg; 7 - 9 pezzi cm spessi	 2; pirofila su lamiera dolci Aggiungere liquido. Girare la carne a metà cottura.
P18	Pollo intero	1 - 1,5 kg; fresco	  2; casseruola sulla lamiera dolci Utilizzare le spezie preferite. Girare il pollo a metà cottura per ottenere una doratura uniforme.
P19	Mezzo pollo	0,5 - 0,8 kg	 3; teglia da forno Utilizzare le spezie preferite.
P20	Pollo, petto	180 - 200 g per pezzo	  2; casseruola su ripiano a filo Utilizzare le spezie preferite. Friggere la carne per alcuni minuti in una padella calda.
P21	Cosce di pollo, fresche	-	 3; lamiera dolci Se le cosce di pollo sono state marinate prima, impostare la temperatura più bassa e cuocerle più a lungo.
P22	Anatra, intera	2 - 3 kg	  2; pirofila su ripiano a filo Utilizzare le spezie preferite. Sistemare la carne sulla teglia. Girare l'anatra a metà cottura.
P23	Oca, intera	4 - 5 kg	  2; leccarda Utilizzare le spezie preferite. Sistemare la carne su una teglia da forno profonda. Girare l'oca a metà cottura.

	Piatto	Peso	Livello / Accessorio ripiano
P24	Polpettone	1 kg	 2; ripiano a filo Utilizzare le spezie preferite.
P25	Pesce intero, grigliato	0.5 - 1 kg per pesce	 2 lamiera dolci Farcire il pesce con burro e utilizzare spezie ed erbe preferite.
P26	Filetto di pesce	-	  3; casseruola su ripiano a filo Utilizzare le spezie preferite.
P27	Torta ai formaggi	-	 2;  28 cm Tortiera apribile su ripiano a filo
P28	Torta di mele	-	 3; lamiera dolci
P29	Crostata di mele	-	 2; tortiera su ripiano a filo
P30	Torta di mele americana	-	 1;  22 cm tortiera su ripiano a filo
P31	Brownies	2 kg di impasto	 3 leccarda
P32	Muffin al cioccolato	-	 3, vassoio muffin su ripiano a filo
P33	Torta di pane	-	 2; leccarda su ripiano a filo
P34	Patate al forno	1 kg	 2; lamiera dolci Mettere le patate intere con buccia sulla lamiera dolci.
P35	Spicchi	1 kg	 3 lamiera dolci rivestita con carta da forno Utilizzare le spezie preferite. Tagliare le patate a pezzi.
P36	Verdure miste grigliate	1 - 1.5 kg	 3 lamiera dolci rivestita con carta da forno Utilizzare le spezie preferite. Tagliare le verdure a pezzi.
P37	Crocchette, surgelate	0.5 kg	 3; lamiera dolci
P38	Patatine, surgelate	0.75 kg	 3; lamiera dolci
P39	Lasagna di carne/ verdure con fogli di pasta secca	1 - 1.5 kg	 2; casseruola su ripiano a filo
P40	Patate gratinate (patate crude)	1 - 1.5 kg	 1; casseruola su ripiano a filo Ruotare il piatto a metà del tempo di cottura.
P41	Pizza fresca, sottile	-	  2; lamiera dolci rivestita con carta da forno
P42	Pizza fresca, spessa	-	  2; lamiera dolci rivestita con carta da forno
P43	Quiche	-	 2; teglia da forno su ripiano a filo

	Piatto	Peso	Livello / Accessorio ripiano
P44	Baguette / Ciabatta / Pane bianco	0.8 kg	 2; lamiera dolci rivestita con carta da forno. Più tempo necessario per il pane bianco.
P45	Pane integrale / se-gale / nero	1 kg	 2; lamiera dolci rivestita con carta forno/leccarda su ripiano a filo

7. FUNZIONI DEL TIMER

7.1 Funzioni orologio

Funzione Orologio	Applicazione
 Contaminuti	Allo scadere del timer, viene emesso un segnale acustico.
 Tempo di cottura	Quando il timer arriva alla fine, si sente un segnale e la funzione cottura si ferma.
 Ritardo	Per posticipare l'inizio e/o la fine della cottura.
 Timer	Il massimo è 23 ore 59 min. Questa funzione non ha nessun effetto sul funzionamento del forno. Per accendere e spegnere Timer selezionare: Menu, Impostazioni.

7.2 Come impostare: Funzioni Orologio

Come impostare: Imposta ora		
Passaggio 1	Passaggio 2	Passaggio 3
		
Per modificare l'ora, accedere al menu e selezionare Impostazioni, Ora.	Impostare l'orologio.	Premere: OK .

Come impostare: Contaminuti

Passaggio 1



Premere: .

Il display visualizza:
0:00

Passaggio 2



Imposta Contaminuti

Passaggio 3



Premere: OK.

 Il timer inizia subito il conto alla rovescia.

Come impostare: Tempo di cottura

Passaggio 1



Selezionare una funzione di cottura e impostare la temperatura.

Passaggio 2



Premere ripetutamente: .

Il display visualizza:
0:00

STOP

Passaggio 3



Impostare la durata della cottura.

Passaggio 4



Premere: OK.

 Il timer inizia subito il conto alla rovescia.

Come impostare: Ritardo

Passaggio 1



Selezionare la funzione riscaldamento.

Passaggio 2



Premere ripetutamente: .

Il display mostra: l'ora del giorno

 START

Passaggio 3



Impostare l'orario di inizio.

Passaggio 4



Premere: OK.

Il display visualizza:
--:--
 STOP

Passaggio 5



Impostare l'orario di fine.

Passaggio 6



Premere: OK.

 Il timer inizia il conto alla rovescia a un orario di inizio impostato.

8. UTILIZZO DEGLI ACCESSORI

AVVERTENZA!

Fare riferimento ai capitoli sulla sicurezza.

8.1 Inserimento di accessori

Un piccolo rientro sulla parte superiore aumenta il livello di sicurezza. Gli incavi sono anche dispositivi antiribaltamento. Il bordo alto intorno al ripiano evita che pentole e padelle scivolino dal ripiano.

Ripiano a filo:

Spingere il ripiano fra le guide del supporto.

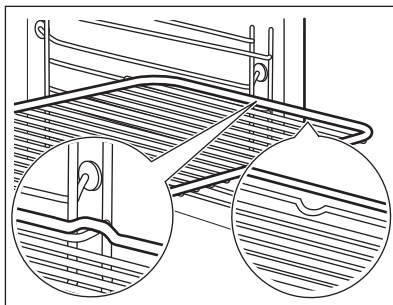

Lamiera dolci / Teglia profonda:

Spingere la lamiera tra le guide del supporto ripiano.

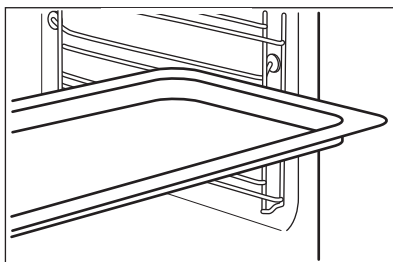

9. FUNZIONI AGGIUNTIVE

9.1 Blocco

Questa funzione evita che si cambi per sbaglio la funzione dell'apparecchiatura.

Attivarla quando l'apparecchiatura è in funzione: la cottura impostata continua, il pannello dei comandi è bloccato.

Attivarla quando l'apparecchiatura è spenta - l'apparecchiatura non può essere accesa, il pannello dei comandi è bloccato.



- tenere premuto per attivare la funzione.
Viene emesso un segnale acustico.





- premere e tenere premuto per disattivarla.

3 x - lampeggia quando il blocco è attivato.

9.2 Spegnimento automatico

Per motivi di sicurezza, se la funzione cottura è attiva e le impostazioni non vengono modificate, l'apparecchiatura si spegne automaticamente dopo un determinato periodo di tempo.

 (°C)	 (h)
30 - 115	12.5
120 - 195	8.5
200 - 245	5.5

 (°C)

250 - massimo

 (h)

3

Lo spegnimento automatico non si attiva con le funzioni: Luce forno, Ritardo.

9.3 Ventola di raffreddamento

Quando l'apparecchiatura è in funzione, la ventola di raffreddamento si attiva in modo automatico per raffreddare le superfici. Dopo aver spento l'apparecchiatura, la ventola di raffreddamento continua a funzionare finché l'apparecchiatura non si è raffreddata.

10. CONSIGLI E SUGGERIMENTI UTILI



10.1 Consigli di cottura



La temperatura e i tempi di cottura specificati nelle tabella sono valori indicativi. Dipendono dalle ricette, dalla qualità e quantità degli ingredienti utilizzati.
La nuova apparecchiatura può cuocere o arrostitire in modo differente rispetto all'apparecchiatura posseduta in precedenza. I suggerimenti seguenti mostrano le impostazioni consigliate per temperatura, tempo di cottura e posizione ripiano per tipi di alimenti specifici.
Qualora non si trovino le impostazioni per una ricetta speciale, cercarne una simile.

10.2 Cottura ventilata umida

Per ottenere i risultati migliori, attenersi ai suggerimenti elencati nella tabella sottostante.

	°C		
Pasta gratinata	200 - 220	45 - 55	3
Patate gratinate	180 - 200	70 - 85	3
Moussaka	170 - 190	70 - 95	3
Lasagne	180 - 200	75 - 90	3
Cannelloni	180 - 200	70 - 85	3
Budino di pane	190 - 200	55 - 70	3
Budino di riso	170 - 190	45 - 60	3
Torta di mele, preparata con miscela per pan di Spagna (stampo per dolci rotondo)	160 - 170	70 - 80	3
Pane bianco	190 - 200	55 - 70	3

10.3 Cottura ventilata umida - accessori consigliati

Usare scatole e contenitori scuri e non riflettenti. Assorbono meglio il calore rispetto al colore chiaro e ai piatti riflettenti.



Teglia da pizza

Scura, non riflettente
28 cm di diametro

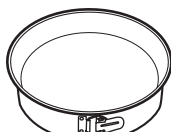

Pirofila

Scura, non riflettente
26 cm di diametro



Pirofile monoporzione

Ceramica
diametro 8 cm, altezza 5 cm



Tortiera per flan





Scura, non riflettente
28 cm di diametro

10.4 Tabelle di cottura per gli istituti di test

Informazioni per gli istituti di test





Test conformemente a: EN 60350, IEC 60350.

Cottura al forno su un livello - cottura in stampi





		 °C	 min	
Pan di Spagna senza grassi	Cottura ventilata	160	45 - 60	2
Pan di Spagna senza grassi	Cottura convenzionale	160	45 - 60	2
Torta di mele americana, 2 stampi Ø20 cm	Cottura ventilata	160	55 - 65	2
Torta di mele americana, 2 stampi Ø20 cm	Cottura convenzionale	180	55 - 65	1
Frollini al burro	Cottura ventilata	140	25 - 35	2
Frollini al burro	Cottura convenzionale	140	25 - 35	2

Cottura al forno su un livello - biscotti

Utilizzare la posizione del terzo ripiano.

		 °C	 min
Tortine, 20 per teglia, preriscaldare il forno vuoto	Cottura ventilata	150	20 - 30
Tortine, 20 per teglia, preriscaldare il forno vuoto	Cottura convenzionale	170	20 - 30





Cottura al forno multilivello - biscotti

		 °C	 min	
Frollini al burro	Cottura ventilata	140	25 - 45	2 / 4
Tortine, 20 per teglia, preriscaldare il forno vuoto	Cottura ventilata	150	25 - 35	1 / 4
Pan di Spagna senza grassi	Cottura ventilata	160	45 - 55	2 / 4
Crostata di mele, 1 stampo per griglia (Ø 20 cm)	Cottura ventilata	160	55 - 65	2 / 4

Grill

Preriscaldare il forno vuoto per 5 minuti.

Grigliare con l'impostazione di temperatura massima.

		 min	
Toast	Grill	1 - 2	5
Manzo, bistecca, girare il piatto a metà cottura	Grill	24 - 30	4

11. PULIZIA E CURA

AVVERTENZA!

Fare riferimento ai capitoli sulla sicurezza.

11.1 Note sulla pulizia



Agenti di pulizia

Pulire la parte anteriore dell'apparecchiatura solo con un panno in microfibra imbevuto di acqua tiepida e detergente delicato.

Servirsi di una soluzione detergente per pulire le superfici metalliche.

Pulire le macchie con un detergente delicato.



Uso quotidiano

Pulire la cavità dopo ogni utilizzo. L'accumulo di grasso o di altri residui potrebbe causare un incendio.

Non lasciare le vivande nell'apparecchiatura per più di 20 minuti. Asciugare la cavità dopo ogni utilizzo solo con un panno in microfibra.



Pulire tutti gli accessori dopo ogni utilizzo e lasciarli asciugare. Utilizzare solo un panno in microfibra imbevuto di acqua tiepida e un detergente delicato. Non pulire gli accessori in lavastoviglie.

Non pulire gli accessori anti-aderenti con agenti abrasivi o oggetti appuntiti.

Accessori

11.2 Come rimuovere: Supporti del ripiano

Rimuovere i supporti ripiano per pulire il forno.

Passaggio 1 Spegner il forno e attendere che si raffreddi.

Passaggio 2 Sfilare dapprima la guida di estrazione dalla parete laterale tirandola in avanti.

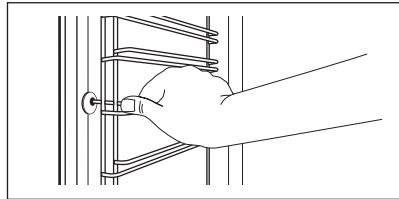

Passaggio 3 Estrarre la parte posteriore del supporto ripiano dalla parete laterale e rimuoverla.

Passaggio 4 Installare i supporti ripiani seguendo al contrario la procedura indicata.

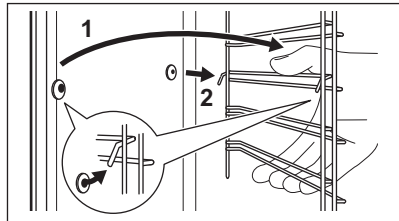

11.3 Istruzioni d'uso: Pulizia per pirolisi

Pulire il forno con Pulizia per pirolisi.

AVVERTENZA!

Rischio di ustioni.

ATTENZIONE!

Se nello stesso armadietto sono installate altre apparecchiature, non utilizzarle allo stesso tempo di questa funzione. Il forno potrebbe subire danni.

Prima della Pulizia per pirolisi:

Spegner il forno e attendere che si raffreddi.

Rimuovere tutti gli accessori e i supporti dei ripiani rimovibili.

Pulire la base del forno e il vetro interno dello sportello con acqua calda, un panno morbido e un detergente delicato.

Pulizia per pirolisi

Passaggio 1

Accedere al menu: Pulizia .

Pulizia per pirolisi

Opzione	Durata
C1 - Pulizia leggera	1 h
C2 - Pulizia normale	1 h 30 min
C3 - Pulizia completa	3 h
Passaggio 2	OK - premere per selezionare il programma di pulizia.
Passaggio 3	OK - premere per avviare la pulizia.
Passaggio 4	Dopo la pulizia, ruotare la manopola delle funzioni di cottura sulla posizione di spento.

 Quando inizia la pulizia, lo sportello del forno è bloccato e la lampadina è spenta. Finché lo sportello non si sblocca il display indica: .

Al termine della pulizia:

Spegnere il forno e attendere che si raffreddi.

Pulire la cavità con un panno morbido.

Rimuovere il residuo dal basso della cavità.

11.4 Promemoria Pulizia

Il forno vi ricorda quando pulirlo con la pulizia pirolitica.

 lampeggia sul display per 5 secondi dopo ogni sessione di cottura.

Per disattivare il promemoria inserire il Menu e selezionare Impostazioni, Promemoria Pulizia.

11.5 Procedura di rimozione e installazione: Porta

È possibile rimuovere la porta e i pannelli in vetro interni per procedere alle operazioni di pulizia. Il numero di pannelli di vetro varia a seconda dei modelli.

AVVERTENZA!

La porta è pesante.

ATTENZIONE!

Maneggiare con cura il vetro, in particolare intorno ai bordi del pannello frontale. Il vetro può rompersi.

Passaggio 1 Aprire completamente la porta.

Passaggio 2 Sollevare e premere le leve di serraggio (A) sulle due cerniere.

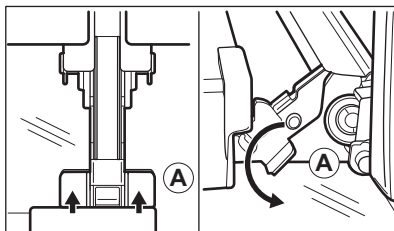

Passaggio 3 Chiudere la porta del forno fino alla prima posizione di apertura (un angolo di circa 70°). Afferrare la porta su entrambi i lati e tirarla fino ad allontanarla dal forno mantenendo un'inclinazione verso l'alto. Poggiare la porta con il lato esterno rivolto verso il basso su un panno morbido su una superficie stabile.

Passaggio 4 Tenere il rivestimento della porta (B) sul bordo superiore della porta da entrambi i lati e spingere verso l'interno per sbloccare la guarnizione a clip.

Passaggio 5 Rimuovere il rivestimento tirandolo in avanti.

Passaggio 6 Afferrare uno ad uno i pannelli di vetro della porta dal bordo superiore e estrarli dalla guida.

Passaggio 7 Pulire il pannello in vetro con acqua e sapone. Asciugare con cura il pannello in vetro. Non pulire i pannelli in vetro in lavastoviglie.

Passaggio 8 Dopo la pulizia, eseguire i passaggi di cui sopra nella sequenza opposta.

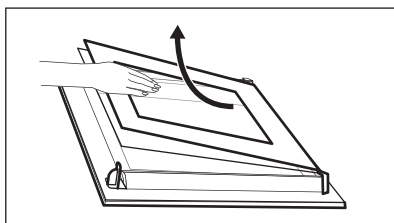
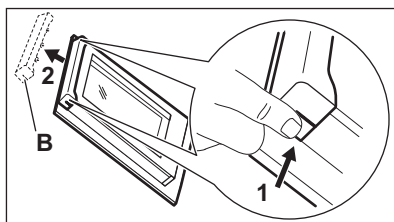

Passaggio 9 Installare per primo il pannello più piccolo, poi quello più grande e la porta.

11.6 Come sostituire: Lampadina

⚠ AVVERTENZA!

Pericolo di scosse elettriche.
La lampada potrebbe essere calda.

Prima di sostituire la lampadina:

Passaggio 1

Spegnere il forno. Attendere che il forno sia freddo.

Passaggio 2

Estrarre la spina dalla presa di corrente.

Passaggio 3

Appoggiare un panno sul fondo della cavità.

Lampadina superiore

Passaggio 1 Girare il rivestimento di vetro per toglierlo.

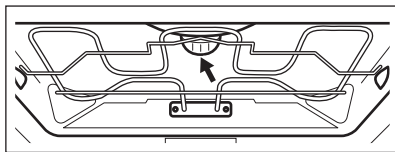

Passaggio 2 Pulire il coperchio in vetro.

Passaggio 3 Sostituire la lampadina con una resistente al calore fino a 300 °C.

Passaggio 4 Installare il coperchio in vetro.

12. RISOLUZIONE DEI PROBLEMI

AVVERTENZA!

Fare riferimento ai capitoli sulla sicurezza.

12.1 Cosa fare se...

Per tutti i casi non inclusi in questa tabella si prega di contattare un Centro di assistenza autorizzato.



L'apparecchiatura non si accende o non si riscalda

Problema	Controllare se...
Non è possibile attivare o mettere in funzione l'apparecchiatura.	L'apparecchiatura è stata collegata in modo corretto all'alimentazione di rete.
L'elettrodomestico non si riscalda.	Lo spegnimento automatico è disattivo.
L'elettrodomestico non si riscalda.	La porta dell'elettrodomestico è chiusa.
L'elettrodomestico non si riscalda.	È saltato il fusibile.
L'elettrodomestico non si riscalda.	Il blocco è disattivato.



Componenti

Problema	Controllare se...
La spia è spenta.	Cottura ventilata umida - è acceso.
La lampadina non funziona.	La lampadina è bruciata.



Codici di errore

Il display visualizza...	Controllare se...
Err C3	La porta dell'elettrodomestico è chiusa o la chiusura della porta non è rotta.
Err F102	La porta dell'elettrodomestico è chiusa.
Err F102	Il blocco della porta non è rotto.
00:00	Si è verificata un'interruzione dell'alimentazione elettrica. Impostare l'ora.

Il display mostra un codice di errore non presente nella tabella. Disattivare e riattivare il fusibile domestico e riavviare l'elettrodomestico. In caso di ricomparsa del codice di errore, contattare il Centro di assistenza autorizzato.

12.2 Dati dell'Assistenza

Qualora non sia possibile trovare una soluzione al problema, contattare il rivenditore o un Centro di assistenza autorizzato.

Le informazioni necessarie per il Centro Assistenza si trovano sulla targhetta dei dati. La targhetta si trova sul telaio anteriore della cavità dell'apparecchiatura. Non rimuovere la

targhetta dei dati dalla cavità dell'apparecchiatura.

Consigliamo di annotare i dati qui:

Modello (Mod.)
Codice prodotto (PNC)
Numero di serie (S.N.)

13. EFFICIENZA ENERGETICA

13.1 Informazioni sul prodotto e scheda informativa del prodotto in conformità alla normativa europea sull'ecodesign e sull'etichettatura energetica

Nome del fornitore	AEG
Identificazione modello	BPK535060B 944188596 BPK535060M 944188597
Indice di efficienza energetica	81.2
Classe di efficienza energetica	A+
Consumo energetico con carico standard, modalità tradizionale	1.09 kWh/ciclo
Consumo di energia con un carico standard, modalità a circolazione d'aria forzata	0.69 kWh/ciclo
Numero di cavità	1
Fonte di calore	Elettricità
Volume	71 l
Tipo di forno	Forno da incasso

Massa	BPK535060B	35.0 kg
	BPK535060M	35.0 kg

IEC/EN 60350-1 - Apparecchiature elettriche per la cottura per uso domestico - Parte 1: Cucine, forni, forni a vapore e griglie - Metodi per la misura delle prestazioni.

13.2 Risparmio energetico

 L'apparecchiatura ha di funzioni che consentono di aiutarvi a risparmiare energia durante le operazioni di cottura di tutti i giorni.

Assicurarsi che la porta dell'apparecchiatura sia chiusa quando l'apparecchiatura è in funzione. Non aprire troppo spesso la porta durante la cottura. Tenere pulita la guarnizione della porta e assicurarsi che sia ben fissata nella posizione corretta.

Servirsi di pentole in metallo per migliorare il risparmio energetico .

Ove possibile, non pre-riscaldare l'apparecchiatura prima della cottura.

Ridurre quanto più possibile gli intervalli fra le diverse operazioni di cottura quando vengono preparati più piatti contemporaneamente.

Cucinare con ventola

Ove possibile, servirsi delle funzioni di cottura con la ventola per risparmiare energia.

Calore residuo

La ventola e la lampada continuano a funzionare. Quando si spegne l'apparecchiatura, il display visualizza il

calore residuo. Si può usare quel calore per mantenere le pietanze in caldo.

Quando la durata di cottura è superiore ai 30 minuti, ridurre la temperatura dell'apparecchiatura al minimo 3-10 minuti prima della fine del processo di cottura. La cottura proseguirà grazie al calore residuo all'interno dell'apparecchiatura.

Utilizzare il calore residuo per scaldare altri piatti.

Tenere in caldo gli alimenti

Scegliere l'impostazione di temperatura più bassa per sfruttare il calore residuo e mantenere calda la pietanza. La spia di calore residuo o la temperatura compaiono sul display.

Cottura con lampada spenta

Spegnere la lampada in fase di cottura. Accenderla solo quando è necessario.

Cottura ventilata umida

Funzione progettata per risparmiare energia in fase di cottura.

Quando si utilizza questa funzione, la lampadina si spegne automaticamente dopo 30 secondi. È possibile riaccendere la lampada, ma questa azione ridurrà i risparmi energetici previsti.

14. STRUTTURA DEL MENU

14.1 Menu

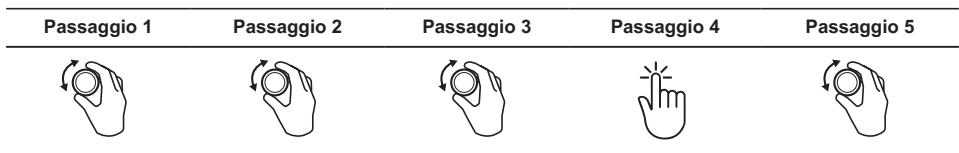



- selezionare per accedere alla Menu.

Selezionare l'opzione dalla struttura Menu e premere **OK**.

Selezionare l'impostazione.

OK - premere per confermare l'impostazione.

Regolare il valore e premere **OK**.

Ruotare la manopola per le funzioni cottura sulla posizione off per uscire da Menu.

Menu struttura

Cottura guidata

Pulizia

Impostazioni

Impostazioni

01	Imposta ora	Modifica	02	Luminosità	1 - 5
03	Volume toni	1 - Bip 2 - Fare clic 3 - Segnale acustico spento	04	Volume acustico	1 - 4
05	Timer	On/Off	06	Luce forno	On/Off
07	Riscaldamento rapido	On/Off	08	Promemoria Pulizia	On/Off
09	Modalità demo	Codice di attivazione: 2468	10	Versione software	Controllare
11	Ripristino impostazioni iniziali di fabbrica	Si / No			

15. CONSIDERAZIONI SULL'AMBIENTE

Riciclare i materiali con il simbolo . Buttare l'imballaggio negli appositi contenitori per il riciclaggio. Aiutare a proteggere l'ambiente e la salute umana e a riciclare rifiuti derivanti da apparecchiature elettriche ed elettroniche. Non smaltire le apparecchiature che riportano

il simbolo insieme ai normali rifiuti domestici. Portare il prodotto al punto di riciclaggio più vicino o contattare il comune di residenza.

Bem-vindo(a) à AEG! Obrigado por escolher o nosso aparelho.



Obtenha conselhos de utilização, brochuras, resolução de problemas, informações sobre assistência e reparações em aeg.com/support



Para mais receitas, sugestões e resolução de problemas, transfira a aplicação **My AEG Kitchen**.



Sujeito a alterações sem aviso prévio.

ÍNDICE

1. INFORMAÇÕES DE SEGURANÇA.....	158
2. INSTRUÇÕES DE SEGURANÇA.....	160
3. DESCRIÇÃO DO PRODUTO.....	164
4. PAINEL DE COMANDOS.....	164
5. ANTES DA PRIMEIRA UTILIZAÇÃO.....	165
6. UTILIZAÇÃO DIÁRIA.....	166
7. FUNÇÕES DE RELÓGIO.....	171
8. UTILIZAR OS ACESSÓRIOS.....	173
9. FUNÇÕES ADICIONAIS.....	173
10. SUGESTÕES E DICAS.....	174
11. MANUTENÇÃO E LIMPEZA.....	177
12. RESOLUÇÃO DE PROBLEMAS.....	180
13. EFICIÊNCIA ENERGÉTICA.....	181
14. ESTRUTURA DO MENU.....	183
15. PREOCUPAÇÕES AMBIENTAIS.....	183

1. ⚠️ INFORMAÇÕES DE SEGURANÇA

Leia atentamente as instruções fornecidas antes de instalar e utilizar o aparelho. O fabricante não é responsável por quaisquer ferimentos ou danos resultantes de instalação ou utilização incorretas. Guarde sempre as instruções em local seguro e acessível para consultar no futuro.

1.1 Segurança de crianças e pessoas vulneráveis

- Este aparelho pode ser utilizado por crianças com 8 anos de idade ou mais velhas e por pessoas com capacidades físicas, sensoriais ou mentais reduzidas ou falta de experiência e conhecimento se forem supervisionadas ou instruídas no que respeita à utilização do aparelho de uma

forma segura e compreenderem os perigos envolvidos. É necessário manter as crianças com menos de 8 anos de idade e pessoas com incapacidades muito extensas e complexas afastadas do aparelho, a menos que sejam constantemente vigiadas.

- As crianças devem ser vigiadas para garantir que não brincam com o aparelho.
- Mantenha todos os materiais de embalagem fora do alcance das crianças e elimine-os de forma apropriada.
- AVISO: O forno e as partes acessíveis ficam quentes durante a utilização. Mantenha as crianças e os animais domésticos afastados do aparelho quando estiver a ser utilizado e durante o arrefecimento.
- Se o aparelho tiver um dispositivo de segurança para crianças, recomendamos que o ative.
- A limpeza e a manutenção básica do aparelho não devem ser efetuadas por crianças sem supervisão.

1.2 Segurança geral

- Este aparelho destina-se apenas a ser utilizado para cozinhar.
- Este aparelho foi concebido unicamente para utilização doméstica num ambiente interior.
- Este aparelho pode ser utilizado em escritórios, quartos de hóspedes de hotéis, quartos de hóspedes de pousadas, casas de hóspedes de turismo rural e outros alojamentos semelhantes onde tal utilização não exceda os níveis de utilização doméstica (médios).
- Apenas uma pessoa qualificada pode instalar este aparelho e substituir o cabo.
- Não use o aparelho antes de instalá-lo na estrutura embutida.
- Desligue o aparelho da fonte de alimentação antes de realizar qualquer manutenção.
- Se o cabo de alimentação elétrica estiver danificado, este deve ser substituído pelo fabricante, por um Centro de

Assistência Técnica Autorizado ou por uma pessoa igualmente qualificada, para evitar perigos elétricos.

- AVISO: Certifique-se de que o aparelho está desligado antes de substituir a lâmpada, para evitar a possibilidade de choque elétrico.
- AVISO: O forno e as partes acessíveis ficam quentes durante a utilização. Deve ter cuidado para evitar tocar nas resistências ou na superfície da cavidade do aparelho.
- Utilize sempre luvas de forno para retirar ou inserir acessórios ou recipientes de ir ao forno.
- Para remover os apoios para prateleiras, puxe primeiro a parte da frente do apoio para prateleiras e depois a extremidade traseira das paredes laterais. Instale os apoios para prateleiras na sequência inversa.
- Não utilize um aparelho de limpeza a vapor para limpar o aparelho.
- Não utilize agentes de limpeza abrasivos ou raspadores metálicos afiados para limpar a porta de vidro, porque podem riscar a superfície e quebrar o vidro.
- Antes da limpeza pirolítica, retire todos os acessórios e depósitos/derrames excessivos da cavidade do aparelho.

2. INSTRUÇÕES DE SEGURANÇA

2.1 Instalação

AVISO!

A instalação deste aparelho tem de ser efetuada por uma pessoa qualificada.

- Retire a embalagem toda.
- Não instale nem utilize o aparelho se estiver danificado.
- Siga as instruções de instalação fornecidas com o aparelho.
- Tenha sempre cuidado quando deslocar o aparelho porque ele é pesado. Utilize sempre luvas de proteção e calçado fechado.
- Não puxe o aparelho pela pega.
- Instale o aparelho num local seguro e adequado que cumpra com os requisitos da instalação.
- Respeite as distâncias mínimas relativamente a outros aparelhos e unidades.
- Antes de montar o aparelho, verifique se a porta do aparelho abre sem limitações.
- O aparelho está equipado com um sistema de arrefecimento elétrico. É necessário utilizar a alimentação elétrica.
- A unidade de encastrar tem de cumprir os requisitos de estabilidade da norma DIN 68930.

Altura mínima do armário
(altura mínima do armário
debaixo do balcão)

578 (600) mm

Largura do armário	560 mm
Profundidade do armário	550 (550) mm
Altura da parte da frente do aparelho	594 mm
Altura da parte de trás do aparelho	576 mm
Largura da parte da frente do aparelho	595 mm
Largura da parte de trás do aparelho	559 mm
Profundidade do aparelho	567 mm
Profundidade de encastre do aparelho	546 mm
Profundidade com a porta aberta	1027 mm
Dimensão mínima da abertura de ventilação. Abertura localizada na parte inferior traseira	560x20 mm
Comprimento do cabo de alimentação elétrica. O cabo sai pelo canto traseiro direito	1500 mm
Parafusos de montagem	4x25 mm

2.2 Ligação elétrica

AVISO!

Risco de incêndio e choque elétrico.

- Todas as ligações elétricas devem ser efectuadas por um electricista qualificado.
- O aparelho tem de ficar ligado à terra.
- Certifique-se de que os parâmetros indicados na placa de características são compatíveis com as características da alimentação elétrica.
- Utilize sempre uma tomada devidamente instalada e à prova de choques elétricos.
- Não utilize adaptadores de tomadas duplas ou triplas, nem cabos de extensão.
- Certifique-se de que não danifica a ficha e o cabo de alimentação elétrica. Se for necessário substituir o cabo de alimentação, esta operação deve ser efectuada pelo nosso Centro de Assistência Técnica.

- Não permita que algum cabo eléctrico toque na porta do aparelho ou no nicho abaixo do aparelho, especialmente quando a porta estiver quente.
- As protecções contra choques eléctricos das peças isoladas e não isoladas devem estar fixas de modo a não poderem ser retiradas sem ferramentas.
- Ligue a ficha à tomada elétrica apenas no final da instalação. Certifique-se de que a ficha fica acessível após a instalação.
- Se a tomada eléctrica estiver solta, não ligue a ficha.
- Não puxe o cabo de alimentação para desligar o aparelho. Puxe sempre a ficha.
- disjuntores de protecção, fusíveis (os fusíveis de rosca devem ser retirados do suporte), diferenciais e contactores.
- A instalação eléctrica deve possuir um dispositivo de isolamento que lhe permita desligar o aparelho da corrente eléctrica em todos os pólos. O dispositivo de isolamento deve ter uma abertura de contacto com uma largura mínima de 3 mm.
- Feche totalmente a porta do aparelho antes de ligar a ficha na tomada eléctrica.
- Este aparelho é fornecido com ficha e cabo de alimentação.

2.3 Utilização

AVISO!

Risco de ferimentos, queimaduras, choque elétrico ou explosão.

- Não altere as especificações deste aparelho.
- Certifique-se de que as aberturas de ventilação não ficam obstruídas.
- Não deixe o aparelho sem vigilância durante o funcionamento.
- Desative o aparelho após cada utilização.
- Tenha cuidado quando abrir a porta do aparelho com o aparelho em funcionamento. Pode sair ar quente.
- Não utilize o aparelho com as mãos molhadas ou quando ele estiver em contacto com água.
- Não aplique pressão sobre a porta aberta.
- Não utilize o aparelho como superfície de trabalho ou armazenamento.

- Abra a porta do aparelho com cuidado. A utilização de ingredientes com álcool pode provocar uma mistura de álcool e ar.
- Evite que faíscas ou chamas entrem em contacto com o aparelho quando abrir a porta.
- Não coloque produtos inflamáveis, nem objetos molhados com produtos inflamáveis, no interior, perto ou em cima do aparelho.

⚠ AVISO!

Risco de danos no aparelho.

- Para evitar danos ou descoloração no esmalte:
 - não coloque recipientes de ir ao forno ou outros objetos diretamente sobre o fundo do aparelho.
 - não coloque folha de alumínio diretamente sobre o fundo da cavidade do aparelho.
 - não coloque água diretamente no aparelho quente.
 - não mantenha pratos e alimentos húmidos no aparelho após acabar de cozinhar.
 - tenha cuidado quando remover ou montar os acessórios.
- A eventual descoloração do esmalte ou do aço inoxidável não afeta o desempenho do aparelho.
- Utilize uma assadeira profunda para bolos húmidos. Os sumos de fruta provocam manchas que podem ser permanentes.
- Cozinhe sempre com a porta do aparelho fechada.
- Se o aparelho ficar instalado atrás de uma porta de armário, nunca feche a porta com o aparelho em funcionamento. Se a porta ficar fechada, poderá ocorrer acumulação de calor e humidade que podem danificar o aparelho, os móveis ou o piso. Não feche a porta do armário enquanto o aparelho não tiver arrefecido completamente após utilização.

2.4 Manutenção e limpeza

⚠ AVISO!

Risco de ferimentos, incêndio ou danos no aparelho.

- Antes de qualquer ação de manutenção, desative o aparelho e desligue a ficha da tomada elétrica.
- Certifique-se de que o aparelho está frio. Existe o risco de quebra dos painéis de vidro.
- Substitua imediatamente os painéis de vidro se estiverem danificados. Contacte um Centro de Assistência Técnica Autorizado.
- Tenha cuidado quando remover a porta do aparelho. A porta é pesada!
- Limpe o aparelho com regularidade para evitar que o material da superfície se deteriore.
- Limpe o aparelho com um pano macio e húmido. Utilize apenas detergentes neutros. Não utilize produtos abrasivos, esfregões abrasivos, solventes ou objetos metálicos.
- Se utilizar um spray para forno, siga as instruções de segurança da embalagem.

2.5 Limpeza pirolítica

⚠ AVISO!

Risco de ferimentos / incêndio / emissão de produtos químicos (vapores) no Modo Pirolítico.

- Antes de efetuar a limpeza pirolítica e o pré-aquecimento inicial, elimine da cavidade do forno:
 - todos os excessos de alimentos, óleos ou derrames de gordura/depósitos.
 - quaisquer objetos amovíveis (incluindo prateleiras, calhas laterais, etc., fornecidos com o aparelho) especialmente tachos antiaderentes, painéis, tabuleiros, utensílios, etc.
- Leia atentamente todas as instruções para a limpeza pirolítica.
- Mantenha as crianças afastadas do aparelho enquanto a limpeza pirolítica estiver a funcionar. O aparelho fica muito quente e liberta ar quente a partir das saídas de arrefecimento.
- A limpeza pirolítica é uma operação efetuada com temperatura elevada e pode libertar fumos dos resíduos alimentares e dos materiais, pelo que recomendamos que:

- garanta uma boa ventilação durante e após cada limpeza pirolítica.
- proporcione uma boa ventilação durante e após o pré-aquecimento inicial.
- Não derrame nem aplique água na porta do forno durante e após a limpeza pirolítica para evitar danificar os painéis de vidro.
- Os fumos libertados por todos os fornos pirolíticos/resíduos de alimentos não são nocivos para pessoas, incluindo crianças, ou pessoas com condições médicas.
- Mantenha os animais de estimação pequenos afastados do aparelho durante e após a limpeza pirolítica e o pré-aquecimento inicial. Os animais de estimação pequenos (especialmente pássaros e répteis) podem ser altamente sensíveis a alterações de temperatura e gases emitidos.
- As superfícies antiaderentes de tachos, panelas, tabuleiros, utensílios, etc., podem ser danificadas pela operação de limpeza pirolítica a alta temperatura de todos os fornos pirolíticos e podem ser fonte de fumos nocivos de baixo nível.

2.6 Iluminação interna

AVISO!

Risco de choque elétrico.

- Relativamente à(s) lâmpada(s) no interior deste produto e às lâmpadas sobressalentes vendidas separadamente:

Estas lâmpadas destinam-se a suportar condições físicas extremas em eletrodomésticos, tais como temperatura, vibração, humidade, ou destinam-se a sinalizar informação relativamente ao estado operacional do aparelho. Não se destinam a ser utilizadas em outras aplicações e não se adequam à iluminação de espaços domésticos.

- Este produto contém uma fonte de luz da classe de eficiência energética G.
- Utilize apenas lâmpadas com as mesmas especificações.

2.7 Assistência técnica

- Para reparar o aparelho, contacte o Centro de Assistência Técnica Autorizado.
- Utilize apenas peças sobressalentes originais.

2.8 Eliminação

AVISO!

Risco de ferimentos ou asfixia.

- Contacte a sua autoridade municipal para saber como descartar o aparelho corretamente.
- Desligue o aparelho da alimentação eléctrica.
- Corte o cabo de alimentação eléctrica do aparelho e elimine-o.
- Remova o trinco da porta para evitar que crianças ou animais de estimação fiquem presos no aparelho.

3. DESCRIÇÃO DO PRODUTO

3.1 Resumo geral

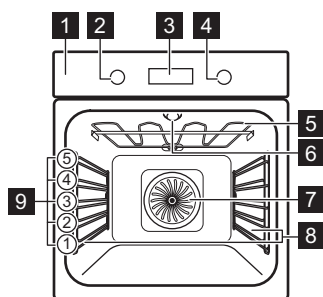

- 1 Painel de comandos
- 2 Botão para os tipos de aquecimento
- 3 Visor
- 4 Botão de controlo
- 5 Elemento de aquecimento
- 6 Lâmpada
- 7 Ventilador
- 8 Apoio para prateleira, amovível
- 9 Nível das prateleiras

3.2 Acessórios

Prateleira em grelha

Para tachos, formas de bolos, assados.

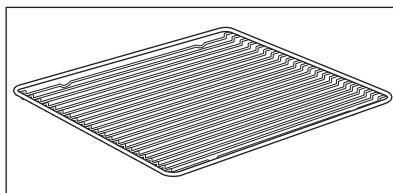

Tabuleiro para assar

Para bolos e biscoitos.

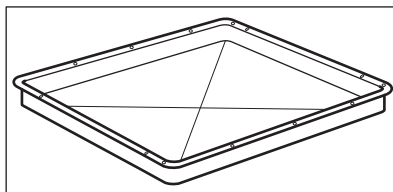

Tabuleiro para grelhar/assar

Para cozer e assar ou como tabuleiro para recolher gordura.

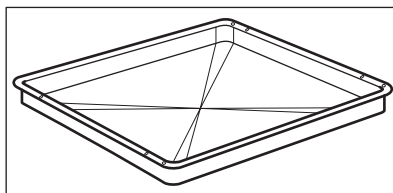

4. PAINEL DE COMANDOS





4.1 Botões retráteis

Para utilizar o aparelho, prima o botão. O botão fica saliente.

4.2 Descrição geral do painel de comandos

Selecione um tipo de aquecimento para ligar o aparelho. Rode o botão para os tipos de

aquecimento para a posição off (desligado) para desligar o aparelho.

				OK
Temporizador	Aquecimento rápido	Luz	Lock	Confirmar a definição

4.3 Visor

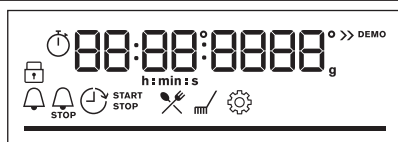

Visor com funções chave.

Indicadores do visor

Indicadores básicos



Indicadores do temporizador

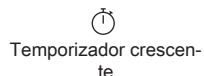

Barra de progresso - para temperatura ou tempo. A barra fica totalmente vermelha quando o aparelho atinge a temperatura definida.



5. ANTES DA PRIMEIRA UTILIZAÇÃO

AVISO!

Consulte os capítulos relativos à segurança.

5.1 Limpeza inicial

Antes da primeira utilização, limpe o aparelho vazio e regule a hora:



00:00

Acertar as horas. Premir OK.

5.2 Pré-aquecimento inicial

Pré-aqueça o forno vazio antes da primeira utilização.

Passo 1 Remova todos os acessórios e apoios para prateleiras amovíveis do forno.

Passo 2 Regule a temperatura máxima para a função: .
Deixe o forno funcionar durante 1 h.

Passo 3 Regule a temperatura máxima para a função: .
Deixe o forno funcionar durante 15 min.

 O forno pode emitir algum odor e fumo durante o pré-aquecimento. Certifique-se de que o espaço é ventilado.

6. UTILIZAÇÃO DIÁRIA

AVISO!





Consulte os capítulos relativos à segurança.







6.1 Como definir: Tipos de aquecimento

Passo 1 Rode o botão para os tipos de aquecimento para selecionar um tipo de aquecimento.

Passo 2 Rode o botão de controlo para definir a temperatura.

6.2 Tipos de aquecimento

Tipo de aquecimento	Aplicação
 Ventilado + Resistência Circ	Para cozer em até três posições de prateleira ao mesmo tempo e para secar alimentos. Regule a temperatura entre 20 e 40 °C abaixo da que utiliza com a função Calor superior/inferior.
 Calor superior/inferior	Para cozer e assar alimentos numa posição de prateleira.
 Congelados	Para deixar os alimentos de conveniência (por exemplo, batatas fritas, batatas em cunha ou crepes) estaladiços.
 Função Pizza	Para cozer pizza. Para um tostado intenso e uma base crocante.

Tipo de aquecimento	Aplicação
 Aquecimento inferior	Para cozer bolos com bases estaladiças e conservar alimentos.
 Descongelar	Para descongelar alimentos (legumes e fruta). O tempo de descongelação depende da quantidade e do tamanho dos alimentos congelados.
 Ventilado com Resistência	Esta função foi concebida para poupar energia durante a cozedura. Quando utilizar esta função, a temperatura no interior do aparelho pode ser diferente da temperatura selecionada. O calor residual é utilizado. A potência de aquecimento pode ser reduzida. Para obter mais informações, consulte o capítulo "Utilização diária", Notas sobre: Ventilado com Resistência.
 Grelhador	Para grelhar alimentos finos e tostar pão.
 Grelhador ventilado	Para assar peças de carne grandes ou aves com ossos numa posição da prateleira. Para fazer gratinados e alourar.
 Menu	Para entrar no menu: Cozedura assistida, Limpeza, Definições.

6.3 Notas sobre: Ventilado com Resistência

Esta função foi utilizada para cumprir com os requisitos de classe de eficiência energética e design ecológico (de acordo com as normas EU 65/2014 e EU 66/2014). Testes de acordo com: IEC/EN 60350-1.

A porta do forno deve estar fechada durante a cozedura para que a função não seja interrompida e o forno funcione com a mais alta eficiência energética possível.

6.4 Como definir: Cozedura assistida

Cada prato deste submenu propõe um tipo de aquecimento e uma temperatura recomendados. Utilize a função para preparar rapidamente um prato com as predefinições. Pode ajustar o tempo e a temperatura durante a cozedura.

Quando a função terminar, verifique se os alimentos estão prontos.

Para alguns dos pratos, também pode cozinhar com:

- Peso automático

Passo 1

Passo 2

Passo 3

Passo 4



Entre no menu.



Selecione a Cozedura assistida. Prima **OK**.



P1 - P...

Selecione o prato. Premir **OK**.



OK

Coloque o prato no forno. Confirme a definição.

6.5 Cozedura assistida

Legenda



Peso automático disponível.







Legenda







































Pré-aqueça o aparelho antes de começar a cozinhar.















Nível da prateleira.

Prato	Peso	Nível de prateleira/ acessório
P1 Carne assada, mal passada		
P2 Carne assada, média	1 - 1.5 kg; 4 - 5 cm pedaços espessos	 2; tabuleiro para assar Frite a carne durante alguns minutos numa frigideira quente. Insira no aparelho.
P3 Carne assada, bem passada		
P4 Bife, médio	180 - 220 g por peça; 3 cm fatias grossas	  3; assadeira numa prateleira em grelha Frite a carne durante alguns minutos numa frigideira quente. Insira no aparelho.
P5 Carne assada/estufada (costeleta de primeira, redondo superior, flanco espesso)	1.5 - 2 kg	  2; assadeira numa prateleira em grelha Frite a carne durante alguns minutos numa frigideira quente. Adicione líquido. Insira no aparelho.
P6 Carne assada, mal passada (aquecimento a baixa temperatura)		
P7 Carne assada, média (aquecimento a baixa temperatura)	1 - 1.5 kg; 4 - 5 cm pedaços espessos	 2; tabuleiro para assar Utilize as suas especiarias favoritas ou simplesmente sal e pimenta moída fresca. Frite a carne durante alguns minutos numa frigideira quente. Insira no aparelho.
P8 Carne assada, bem passada (aquecimento a baixa temperatura)		





	Prato	Peso	Nível de prateleira/ acessório
P9	Filete de carne de vaca, mal passado (aquecimento a baixa temp.)		
P10	Filete de carne de vaca, médio (aquecimento a baixa temp.)	0,5 - 1,5 kg; 5 - 6 cm pedaços espessos	 2; tabuleiro para assar Utilize as suas especiarias favoritas ou simplesmente sal e pimenta moída fresca. Frite a carne durante alguns minutos numa frigideira quente. Insira no aparelho.
P11	Filete de carne de vaca, bem passado (aquecimento a baixa temp.)		
P12	Vitela assada (p. ex., pá)	0,8 - 1,5 kg; 4 cm pedaços espessos	  2; assadeira numa prateleira em grelha Utilize as suas especiarias favoritas. Adicione líquido. Assado coberto.
P13	Cachaço ou pá de porco assada	1,5 - 2 kg	  2; assadeira numa prateleira em grelha Após metade do tempo de cozedura, vire a carne.
P14	Porco assado (aquecimento a baixa temperatura)	1,5 - 2 kg	 2; tabuleiro para assar Utilize as suas especiarias favoritas. Vire a carne após metade do tempo de cozedura para obter um tostado uniforme.
P15	Lombo de porco, fresco	1 - 1,5 kg; 5 - 6 cm pedaços espessos	 2; assadeira numa prateleira em grelha Utilize as suas especiarias favoritas.
P16	Entrecosto de porco	2 - 3 kg; utilizar entrecosto cru, 2 - 3 cm de grossura	 3; tabuleiro para grelhar Adicione líquido para cobrir o fundo de um prato. Após metade do tempo de cozedura, vire a carne.
P17	Perna de borrego com ossos	1,5 - 2 kg; 7 - 9 pedaços com cm de grossura	 2; assadeira no tabuleiro para assar Adicione líquido. Após metade do tempo de cozedura, vire a carne.
P18	Frango inteiro	1 - 1,5 kg; fresco	  2; caçarola no tabuleiro para assar Utilize as suas especiarias favoritas. Vire o frango após metade do tempo de cozedura para obter um tostado uniforme.
P19	Meio frango	0,5 - 0,8 kg	 3; tabuleiro para assar Utilize as suas especiarias favoritas.
P20	Peito de frango	180 - 200 g por peça	  2; caçarola na prateleira em grelha Utilize as suas especiarias favoritas. Frite a carne durante alguns minutos numa frigideira quente.
P21	Pernas de frango, frescas	-	 3; tabuleiro para assar Se marinar as pernas de frango primeiro, defina uma temperatura mais baixa e cozinhe-as durante mais tempo.

	Prato	Peso	Nível de prateleira/ acessório
P22	Pato inteiro	2 - 3 kg	  2; assadeira numa prateleira em grelha Utilize as suas especiarias favoritas. Coloque a carne numa assadeira. Vire o pato após metade do tempo de cozedura.
P23	Ganso, inteiro	4 - 5 kg	  2; tabuleiro para grelhar Utilize as suas especiarias favoritas. Coloque a carne num tabuleiro para assar fundo. Vire o ganso após metade do tempo de cozedura.
P24	Rolo de Carne	1 kg	 2; prateleira em grelha Utilize as suas especiarias favoritas.
P25	Peixe inteiro, grelhado	0.5 - 1 kg por peixe	 2; tabuleiro para assar Encha o peixe com manteiga e utilize as suas especiarias e ervas favoritas.
P26	Filete de peixe	-	  3; caçarola na prateleira em grelha Utilize as suas especiarias favoritas.
P27	Cheesecake	-	 2;  28 cm forma de mola na prateleira em grelha
P28	Bolo de maçã	-	 3; tabuleiro para assar
P29	Tarte de maçã coberta	-	 2; forma circular na prateleira em grelha
P30	Tarte de maçã	-	 1;  22 cm forma circular na prateleira em grelha
P31	Brownies	2 kg de massa	 3; tabuleiro para grelhar
P32	Queques de chocolate	-	 3; tabuleiro de queques na prateleira em grelha
P33	Bolo em forma de pão	-	 2; tabuleiro de pão na prateleira em grelha
P34	Batatas assadas	1 kg	 2; tabuleiro para assar Coloque as batatas inteiras com a pele no tabuleiro para assar.
P35	Fatias	1 kg	 3; tabuleiro para assar forrado com papel vegetal Utilize as suas especiarias favoritas. Corte as batatas em pedaços.
P36	Legumes misturados	1 - 1.5 kg	 3; tabuleiro para assar forrado com papel vegetal Utilize as suas especiarias favoritas. Corte os legumes em pedaços.
P37	Croquetes, congelados	0.5 kg	 3; tabuleiro para assar

	Prato	Peso	Nível de prateleira/acessório
P38	Batatas congeladas	0.75 kg	 3; tabuleiro para assar
P39	Lasanha de carne/ legumes com folhas de massa seca	1 - 1.5 kg	 2; caçarola na prateleira em grelha
P40	Batatas gratinadas (batatas cruas)	1 - 1.5 kg	 1; caçarola na prateleira em grelha Rode o prato após metade do tempo de cozedura.
P41	Pizza fresca, fina	-	  2; tabuleiro para assar forrado com papel vegetal
P42	Pizza fresca, grossa	-	  2; tabuleiro para assar forrado com papel vegetal
P43	Quiche	-	 2; forma de assar na prateleira em grelha
P44	Baguete/ Ciabatta/Pão branco	0.8 kg	  2; tabuleiro para assar revestido com papel vegetal Mais tempo necessário para o pão branco.
P45	Grão integral / Cen- teio / Pão escuro	1 kg	  2; tabuleiro para assar forrado com papel vegetal / tabuleiro de pão na prateleira em grelha

7. FUNÇÕES DE RELÓGIO

7.1 Funções do relógio

Função de relógio	Aplicação
 Conta-minutos	É emitido um sinal sonoro quando o tempo terminar.
 Tempo para cozinhar	Quando o temporizador termina é emitido um sinal sonoro e a função de aquecimento pára.
 Atraso do temporizador	Para adiar o início e/ou final do cozinhado.
 Temporizador crescente	O máximo é de 23 h 59 min. Esta função não afeta o funcionamento do forno. Para ligar e desligar o Temporizador crescente seleccione: Menu, Definições.

7.2 Como definir: Funções do relógio

Como definir: Hora		
Passo 1	Passo 2	Passo 3

Como definir: Hora



para alterar a hora do dia, entre no menu e sele-
cione Definições, Hora do dia.

Acertar o relógio.

Premir: OK.

Como definir: Conta-minutos

Passo 1



Premir: .

O visor mostra:
0:00

Passo 2



Definir a Conta-minutos

Passo 3



Premir: OK.

 O temporizador inicia a contagem decrescente imediatamente.

Como definir: Tempo para cozinhar

Passo 1



Escolha uma função
de aquecimento e defi-
na a temperatura.

Passo 2



Prima repetidamen-
te: .

O visor mostra:
0:00

STOP

Passo 3



Defina o tempo da
cozedura.

Passo 4



Premir: OK.

 O temporizador inicia a contagem decrescente imediatamente.

Como definir: Atraso do temporizador

Passo 1



Selecione
a função
de aqueci-
mento.

Passo 2



Prima repeti-
damente: .

 INICI-
AR

Passo 3



Defina a ho-
ra de início.

Passo 4



Premir: OK.

O visor
mostra:
--:--
 PARAR

Passo 5



Defina a ho-
ra de fim.

Passo 6



Premir:
OK.

 O temporizador inicia a contagem decrescente a uma hora de início definida.

8. UTILIZAR OS ACESSÓRIOS

AVISO!

Consulte os capítulos relativos à segurança.

8.1 Inserir acessórios

Um pequeno entalhe na parte inferior aumenta a segurança. Os entalhes são

também dispositivos anti-inclinação. A armação elevada à volta da prateleira impede que os recipientes deslizem para fora da prateleira.

Prateleira em grelha:

Introduza a prateleira entre as barras-guia do apoio para prateleiras.

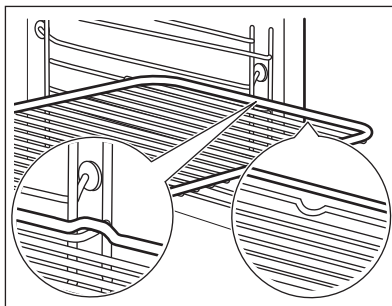

Tabuleiro para assar / Tabuleiro para grelhar:

Introduza o tabuleiro entre as barras-guia do apoio para prateleiras.

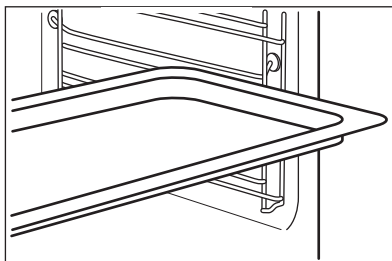

9. FUNÇÕES ADICIONAIS

9.1 Bloquear

Esta função evita uma alteração acidental da função do aparelho.

Ligá-la com o aparelho a funcionar – a cozedura definida continua, o painel de comandos fica bloqueado.
Ligá-la quando o aparelho estiver desligado – não pode ser ligada, o painel de comandos está bloqueado.

Esta função evita uma alteração acidental da função do aparelho.



- mantenha premido para ligar a função.
 - mantenha premido para desligar.
É emitido um sinal sonoro.

3 x - fica intermitente quando o bloqueio está ativo.

9.2 Desativação automática

Por motivos de segurança, se o tipo de aquecimento estiver ativo e não forem alteradas quaisquer definições, o aparelho desliga-se automaticamente após um determinado período de tempo.

(°C)	(h)
30 - 115	12.5
120 - 195	8.5
200 - 245	5.5

(°C)	(h)
250 - máximo	3

O desligamento automático não funciona com as funções: Luz, Atraso do temporizador.

9.3 Ventoinha de arrefecimento

Quando o aparelho está a funcionar, a ventoinha de arrefecimento liga-se automaticamente para manter as superfícies do aparelho frias. Se desligar o aparelho, a ventoinha de arrefecimento pode continuar a funcionar até o aparelho arrefecer.

10. SUGESTÕES E DICAS

10.1 Recomendações para cozinhar



A temperatura e os tempos de cozedura indicados nas tabelas são apenas valores de referência. Dependem das receitas e da qualidade e quantidade dos ingredientes utilizados.



O seu aparelho pode ter um processo para cozer ou assar diferente do aparelho que utilizava anteriormente. As sugestões abaixo exibem as definições recomendadas para temperatura, tempo de cozedura e posições da prateleira para tipos específicos de alimentos.

Se não encontrar as regulações para alguma receita específica, procure uma semelhante.

10.2 Ventilado com Resistência

Para os melhores resultados, siga as sugestões listadas na tabela abaixo.

	°C		
Massa Gratinada	200 - 220	45 - 55	3

	°C		
Batatas gratinadas	180 - 200	70 - 85	3
Moussaka	170 - 190	70 - 95	3
Lasanha	180 - 200	75 - 90	3
Canelones	180 - 200	70 - 85	3
Pudim de pão	190 - 200	55 - 70	3
Pudim de arroz	170 - 190	45 - 60	3
Bolo de maçã, feito com massa batida (forma de bolo redonda)	160 - 170	70 - 80	3
Pão branco	190 - 200	55 - 70	3

10.3 Ventilado com Resistência - acessórios recomendados

Utilize os tabuleiros e recipientes escuros e não refletores. Têm melhor absorção do calor do que a loiça de cor clara e refletora.



Forma para pizza

Escuro, não refletor
28 cm de diâmetro

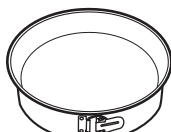

Assadeira

Escuro, não refletor
26 cm de diâmetro



Formas individuais

Vitrocerâmica
8 cm de diâmetro,
5 cm de altura



Forma com base para flan



Escuro, não refletor
28 cm de diâmetro





10.4 Tabelas de cozedura para testes

Informação para institutos de teste

Testes de acordo com: EN 60350, IEC 60350.





Cozer num nível - cozer em formas

		°C	min	
Pão-de-ló sem gordura	Ventilado + Resistência Circ	160	45 - 60	2
Pão-de-ló sem gordura	Calor superior/inferior	160	45 - 60	2
Tarte de maçã, 2 formas, Ø 20 cm	Ventilado + Resistência Circ	160	55 - 65	2





		 °C	 min	
Tarte de maçã, 2 formas, Ø 20 cm	Calor superior/inferior	180	55 - 65	1
Pão pequeno	Ventilado + Resistência Circ	140	25 - 35	2
Pão pequeno	Calor superior/inferior	140	25 - 35	2

Cozer num nível - biscoitos

Usar a terceira posição de prateleira.

		 °C	 min
Bolos pequenos, 20 por tabuleiro, pré-aquecer o forno vazio	Ventilado + Resistência Circ	150	20 - 30
Bolos pequenos, 20 por tabuleiro, pré-aquecer o forno vazio	Calor superior/inferior	170	20 - 30





Cozer em vários níveis - biscoitos

		 °C	 min	
Pão pequeno	Ventilado + Resistência Circ	140	25 - 45	2 / 4
Bolos pequenos, 20 por tabuleiro, pré-aquecer o forno vazio	Ventilado + Resistência Circ	150	25 - 35	1 / 4
Pão-de-ló sem gordura	Ventilado + Resistência Circ	160	45 - 55	2 / 4
Tarte de maçã, 1 forma por grelha (Ø 20 cm)	Ventilado + Resistência Circ	160	55 - 65	2 / 4

Grelhador

Pré-aqueça o forno vazio durante 5 minutos.

Grelhador com a regulação de temperatura máxima.

		 min	
Tosta	Grelhador	1 - 2	5
Bife de vaca, vire a meio do tempo	Grelhador	24 - 30	4

11. MANUTENÇÃO E LIMPEZA

AVISO!

Consulte os capítulos relativos à segurança.

11.1 Notas sobre a limpeza



Agentes de limpeza

Limpe a parte da frente do aparelho apenas usando um pano de microfibras com água morna e um detergente suave.

Utilize uma solução de limpeza para limpar as superfícies metálicas.

Limpe manchas com um detergente suave.



Utilização diária

Limpe a cavidade após cada utilização. A acumulação de gordura ou outros resíduos pode provocar incêndios.

Não guarde alimentos no aparelho durante mais de 20 minutos. Seque a cavidade apenas usando um pano de microfibras após cada utilização.



Acessórios

Limpe todos os acessórios após cada utilização e deixe-os secar. Utilize um pano de microfibras com água morna e um detergente suave. Não lave os acessórios na máquina de lavar loiça.

Não limpe acessórios antiaderentes utilizando detergentes abrasivos ou objetos afiados.

11.2 Como remover: Apoios para prateleiras

Retire os apoios para prateleiras para limpar o forno.

Passo 1 Desligar o forno e aguardar até estar frio.

Passo 2 Puxe a parte da frente do apoio para prateleiras para fora da parede lateral.

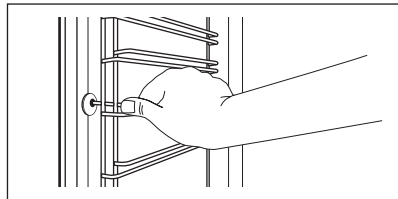

Passo 3 Puxe a parte de trás do apoio para prateleiras para fora da parede lateral e retire-o.

Passo 4 Instale os apoios para prateleiras na sequência inversa.

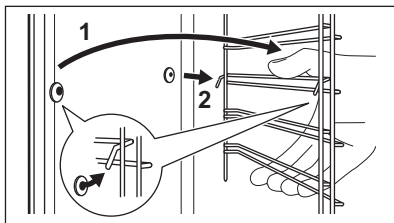

11.3 Como utilizar: Limpeza pirolítica

Limpeza do forno com Limpeza pirolítica.

⚠ AVISO!

Existe o risco de queimaduras.

⚠ CUIDADO!

Se existirem outros aparelhos instalados no mesmo armário, não os utilize enquanto estiver a utilizar esta função. Isso pode danificar o forno.

Antes da Limpeza pirolítica:

Desligue o forno e aguarde até estar frio.

Remova todos os acessórios e apoios para prateleiras amovíveis.

Limpe a base do forno e a porta interna de vidro com água morna, um pano macio e detergente suave.

Limpeza pirolítica

Passo 1

Aceda ao menu: Limpeza mf .

Opção	Duração
C1 - Limpeza ligeira	1 h
C2 - Limpeza normal	1 h 30 min
C3 - Limpeza completa	3 h

Passo 2

OK – prima para seleccionar o programa de limpeza.

Passo 3

OK – prima para iniciar a limpeza.

Passo 4

Após a limpeza, rode o botão das funções de aquecimento para a posição de desligado.

ⓘ Quando a limpeza for iniciada, a porta do forno é bloqueada e a lâmpada é desligada. Até a porta desbloquear, o visor apresenta: mf .

Quando a limpeza termina:

Desligue o forno e aguarde até estar frio.

Limpe a cavidade com um pano macio.

Retire os resíduos do fundo da cavidade.

11.4 Aviso de limpeza

O forno lembra-lhe quando deve limpá-lo com limpeza pirolítica.

 pisca no visor durante 5 segundos após cada sessão de cozedura.

Para desligar o lembrete, introduza o Menu e seleccione Definições, Aviso de limpeza.

11.5 Como remover e instalar: Porta

Pode remover a porta e os painéis de vidro internos para os limpar. O número de painéis de vidro varia consoante o modelo.

AVISO!

A porta é pesada.

CUIDADO!

A força exercida, sobretudo nas extremidades do painel frontal, pode provocar a quebra do vidro. O vidro pode quebrar.

Passo 1 Abrir a porta totalmente.

Passo 2 Levante e prima as alavancas de fixação (A) nas duas dobradiças da porta.

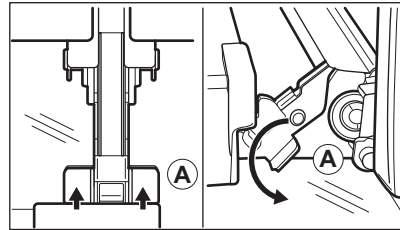

Passo 3 Feche a porta do forno até à primeira posição de abertura (ângulo aproximado de 70°). Segure na porta em ambos os lados e puxe-a para fora do forno num ângulo ascendente. Coloque a porta com o lado exterior virado para baixo sobre um pano e sobre uma superfície estável.

Passo 4 Segure no friso da porta (B) no rebordo superior da porta, nos dois lados, e pressione para dentro para soltar o fecho de encaixe.

Passo 5 Puxe o friso da porta para a frente para o remover.

Passo 6 Segure os painéis de vidro da porta, um após o outro, pela extremidade superior e puxe-os para cima, para fora da guia.

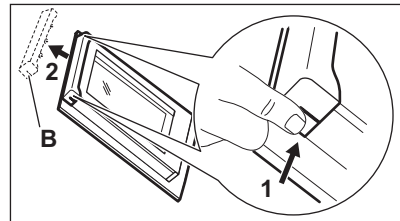

Passo 7 Limpe o painel de vidro com água e sabão. Seque o painel de vidro com cuidado. Não lave os acessórios na máquina de lavar loiça.

Passo 8 Após a limpeza, efetue os passos descritos acima na sequência inversa.

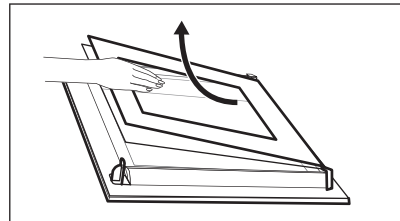

Passo 9 Insira primeiro o painel mais pequeno, depois o maior e por fim a porta.

11.6 Como substituir: Lâmpada

AVISO!

Risco de choque elétrico.
A lâmpada pode estar quente.

Antes de substituir a lâmpada:

Passo 1	Passo 2	Passo 3
Desligue o forno. Aguarde até que o forno esteja frio.	Desligue o forno da corrente elétrica.	Coloque um pano no fundo da cavidade.

Lâmpada superior

Passo 1 Rode a proteção de vidro para a retirar.

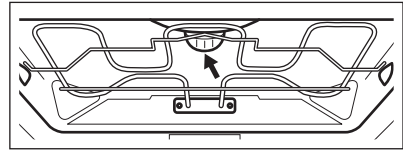

Passo 2 Limpe a cobertura de vidro.

Passo 3 Substitua a lâmpada por uma lâmpada adequada, resistente ao calor até 300 °C.

Passo 4 Instale a cobertura de vidro.

12. RESOLUÇÃO DE PROBLEMAS

AVISO!

Consulte os capítulos relativos à segurança.

12.1 O que fazer se...

Em quaisquer casos não incluídos nesta tabela, contacte um centro de assistência autorizado.



O aparelho não liga ou não aquece

Problema	Verificar se...
Não consegue ativar ou utilizar o aparelho.	O aparelho está ligado corretamente a uma fonte elétrica.
O aparelho não aquece.	O desligar automático foi desativado.
O aparelho não aquece.	A porta do aparelho está fechada.
O aparelho não aquece.	O fusível não está fundido.



O aparelho não liga ou não aquece

O aparelho não aquece.

O Bloqueio está desativado.



Componentes

Problema

Verificar se...

A lâmpada está desligada.

Ventilado com Resistência - está ativada.

A lâmpada não funciona.

A lâmpada está fundida.



Códigos de erro

O visor mostra...

Verificar se...

Err C3

A porta do aparelho está fechada ou o bloqueio da porta não está partido.

Err F102

A porta do aparelho está fechada.

Err F102

O bloqueio da porta não está partido.

00:00

Houve um corte de energia. Definir a hora do dia.

Se o visor apresentar um código de erro que não esteja presente nesta tabela, desligue e volte a ligar o quadro elétrico de casa para reiniciar o aparelho. Se o código de erro recorrer, contacte um Centro de Assistência Técnica Autorizado.

12.2 Dados de assistência técnica

Se não conseguir encontrar uma solução para o problema, contacte o seu fornecedor ou um Centro de Assistência Técnica Autorizado.

Os dados necessários para o centro de assistência técnica encontram-se na placa de identificação do aparelho. A placa de características está na moldura frontal da cavidade do aparelho. Não remova a placa de características da cavidade do aparelho.

Recomendamos que escreva os dados aqui:

Modelo (MOD.)

Número do produto (PNC)

Número de série (S.N.)

13. EFICIÊNCIA ENERGÉTICA

13.1 Informação do produto e folheto de informação do produto de acordo com os Regulamentos de Ecodesign e Rotulagem de Energia da UE

Nome do fornecedor

AEG

Identificação do modelo	BPK535060B 944188596 BPK535060M 944188597	
Índice de Eficiência Energética	81,2	
Classe de eficiência energética	A+	
Consumo de energia com uma carga normal, modo convencional	1,09 kWh/ciclo	
Consumo de energia com uma carga padrão, modo de ventilação forçada	0,69 kWh/ciclo	
Número de cavidades	1	
Fonte de calor	Eletricidade	
Volume	71 l	
Tipo de forno	Forno encastrado	
Massa	BPK535060B	35.0 kg
	BPK535060M	35.0 kg

IEC/EN 60350-1 - Aparelhos de cozinha elétricos domésticos - Parte 1: Fogões, fornos, fornos a vapor e grelhadores - Métodos para medir o desempenho.

13.2 Poupança de energia



O aparelho possui funções que ajudam a poupar energia nos cozinhados de todos os dias.

Certifique-se de que a porta do aparelho está fechada quando o aparelho funcionar. Não abra a porta do aparelho muitas vezes durante a confeção. Mantenha a junta da porta limpa e certifique-se de que está bem fixa na posição correta.

Utilize recipientes de metal para melhorar a poupança de energia.

Sempre que possível, não pré-aqueça o aparelho antes de cozinhar.

Quando preparar vários pratos de uma vez, reduza ao mínimo possível os intervalos entre confeções.

Cozinhar com a ventoinha

Sempre que possível, utilize as funções de cozedura que utilizam a ventoinha, para poupar energia.

Aquecimento residual

O ventilador e a lâmpada continuam ligadas. Quando desligar o aparelho, o visor indica o

calor residual. Pode utilizar esse calor para manter os alimentos quentes.

Quando a duração da cozedura for superior a 30 min, reduza a temperatura do aparelho para 3 a 10 min no mínimo antes do fim da cozedura. O calor residual no interior do aparelho continuará a cozinhar.

Utilize o calor residual para aquecer outros pratos.

Manter os alimentos quentes

Para utilizar o calor residual para manter uma refeição quente, seleccione a regulação de temperatura mais baixa possível. O visor apresenta o indicador de calor residual ou a temperatura.

Cozinhar com a lâmpada desligada

Desligue a lâmpada durante a cozedura. Ligue-a apenas quando precisar.







Ventilado com Resistência

Função concebida para poupar energia durante a cozedura.

Quando utilizar esta função, a lâmpada é desligada automaticamente após 30 seg. Pode ligar a lâmpada novamente, mas isso reduz a poupança de energia esperada.

14. ESTRUTURA DO MENU

14.1 Menu

Passo 1	Passo 2	Passo 3	Passo 4	Passo 5
				
 - selecione para entrar no Menu.	Selecione a opção a partir da Menu estrutura e prima OK .	Selecione a definição.	OK - prima para confirmar a definição.	Ajuste o valor e prima OK .
Rode o botão dos tipos de aquecimento para a posição de desligado para de Menu.				

Menu estrutura.

Cozedura assistida 

Limpeza 

Definições 

Definições

01	Hora	Alterar	02	Brilho do visor	1 - 5
03	Sons "teclado"	1 - Sinal sonoro 2 - Clique 3 - Som desligado	04	Volume do alarme	1 - 4
05	Temporizador crescente	Ligado/Desligado	06	Luz	Ligado/Desligado
07	Aquecimento rápido	Ligado/Desligado	08	Aviso de limpeza	Ligado/Desligado
09	Modo Demo	Código de ativação: 2468	10	Versão do software	Verificar
11	Restaurar configurações	Sim / Não			

15. PREOCUPAÇÕES AMBIENTAIS

Recicle os materiais que apresentem o símbolo . Coloque a embalagem nos contentores indicados para reciclagem. Ajude a proteger o ambiente e a saúde pública através da reciclagem dos aparelhos eléctricos e electrónicos. Não elimine os

aparelhos que tenham o símbolo  juntamente com os resíduos domésticos. Coloque o produto num ponto de recolha para reciclagem local ou contacte as suas autoridades municipais.

Le damos la bienvenida a AEG. Gracias por elegir nuestro aparato.



Obtenga consejos, folletos, soluciones a problemas e información de servicio y reparación en aeg.com/support



Para más recetas, consejos y resolución de problemas, descargue la aplicación **My AEG Kitchen**.



Salvo modificaciones.

CONTENIDO

1. INFORMACIÓN SOBRE SEGURIDAD.....	184
2. INSTRUCCIONES DE SEGURIDAD.....	186
3. DESCRIPCIÓN DEL PRODUCTO.....	190
4. PANEL DE CONTROL.....	190
5. ANTES DEL PRIMER USO.....	191
6. USO DIARIO.....	192
7. FUNCIONES DEL RELOJ.....	197
8. USO DE LOS ACCESORIOS.....	198
9. FUNCIONES ADICIONALES.....	199
10. CONSEJOS.....	200
11. MANTENIMIENTO Y LIMPIEZA.....	202
12. SOLUCIÓN DE PROBLEMAS.....	206
13. EFICACIA ENERGÉTICA.....	207
14. ESTRUCTURA DEL MENÚ.....	208
15. ASPECTOS MEDIOAMBIENTALES.....	209

1. ⚠ INFORMACIÓN SOBRE SEGURIDAD

Antes de instalar y utilizar el aparato, lea atentamente las instrucciones facilitadas. El fabricante no se hace responsable de lesiones o daños producidos como resultado de una instalación o un uso incorrectos. Conserve siempre estas instrucciones en lugar seguro y accesible para futuras consultas.

1.1 Seguridad de niños y personas vulnerables

- Este aparato puede ser utilizado por niños de 8 años en adelante y personas cuyas capacidades físicas, sensoriales o mentales estén disminuidas o que carezcan de la experiencia y conocimientos suficientes para manejarlo,

siempre que cuenten con las instrucciones o la supervisión sobre el uso del electrodoméstico de forma segura y comprendan los riesgos. Es necesario mantener alejados del aparato a los niños de menos de 8 años, así como a las personas con minusvalías importantes y complejas, salvo que estén bajo supervisión continua.

- Es necesario vigilar a los niños para que no jueguen con el aparato.
- Mantenga todo el material de embalaje fuera del alcance de los niños y deséchelo de forma adecuada.
- **ADVERTENCIA:** El horno y las piezas accesibles se calientan mucho durante el funcionamiento. Mantenga a los niños y las mascotas alejados del aparato cuando esté en uso y cuando se enfríe.
- Si este aparato tiene un bloqueo de seguridad para niños, debe activarlo.
- La limpieza y mantenimiento de usuario del producto no podrán ser realizados por niños sin supervisión.

1.2 Instrucciones generales de seguridad

- Este aparato está diseñado exclusivamente para cocinar.
- Este aparato está diseñado para uso doméstico en interiores.
- Este aparato se puede utilizar en oficinas, habitaciones de hotel, habitaciones de Bed&Breakfast, casas de campo y otros alojamientos similares donde dicho uso no exceda (en promedio) los niveles de uso doméstico.
- Solo un electricista cualificado puede instalar este aparato y sustituir el cable.
- No utilice el aparato antes de instalarlo en la estructura empotrada.
- Desenchufe el aparato de la red eléctrica antes de realizar tareas de mantenimiento.
- Si el cable de alimentación presenta algún daño, el fabricante, su servicio técnico autorizado o un profesional tendrán que cambiarlo para evitar riesgos.

- **ADVERTENCIA:** Asegúrese de que el aparato está apagado antes de cambiar la bombilla para evitar el riesgo de descarga eléctrica.
- **ADVERTENCIA:** El horno y las piezas accesibles se calientan mucho durante el funcionamiento. Debe tener cuidado para evitar tocar los elementos de calentamiento o la superficie del interior del aparato.
- Utilizar siempre guantes o manoplas para horno para retirar o introducir accesorios o recipientes.
- Para retirar los carriles de apoyo, tire primero del frontal del carril y, a continuación, separe el extremo trasero de las paredes laterales. Instale los carriles de apoyo en el orden inverso.
- No utilice un limpiador a vapor para limpiar el aparato.
- No utilice productos de limpieza abrasivos ásperos ni rascadores de metal afilado para limpiar el cristal de las tapas abisagradas de la placa si no quiere arañar su superficie, lo que podría hacer que el cristal se hiciese añicos.
- Antes de la limpieza pirolítica, retirar todos los accesorios y cualquier depósito/derrames que haya en el interior del aparato.

2. INSTRUCCIONES DE SEGURIDAD

2.1 Instalación

ADVERTENCIA!

Solo un técnico cualificado puede instalar el aparato.

- Retire todo el embalaje.
- No instale ni utilice un aparato dañado.
- Siga las instrucciones de instalación suministradas con el aparato.
- Tenga cuidado al mover el aparato, porque es pesado. Utilice siempre guantes de protección y calzado cerrado.
- No tire nunca del aparato sujetando el asa.
- Instale el aparato en un lugar seguro y adecuado que cumpla los requisitos de instalación.
- Respete siempre la distancia mínima entre el aparato y los demás electrodomésticos y mobiliario.
- Antes de montar el aparato, compruebe si la puerta se abre sin limitaciones.
- El aparato está equipado con un sistema de refrigeración eléctrica. Debe utilizarse con la fuente de alimentación eléctrica.
- La unidad empotrada debe cumplir los requisitos de estabilidad de la norma DIN 68930.

Altura mínima del armario (Altura mínima del armario debajo de la encimera)	578 (600) mm
Ancho del armario	560 mm
Profundidad del armario	550 (550) mm
Altura de la parte frontal del aparato	594 mm
Altura de la parte trasera del aparato	576 mm
Anchura de la parte frontal del aparato	595 mm
Anchura de la parte trasera del aparato	559 mm
Fondo del aparato	567 mm
Fondo empotrado del aparato	546 mm
Fondo con la puerta abierta	1027 mm
Tamaño mínimo de la abertura de ventilación. Abertura situada en la parte trasera inferior	560x20 mm
Longitud del cable de alimentación. El cable está en la esquina derecha de la parte trasera	1500 mm
Tornillos de montaje	4x25 mm

2.2 Conexión eléctrica

ADVERTENCIA!

Riesgo de incendios y descargas eléctricas.

- Todas las conexiones eléctricas deben realizarlas electricistas cualificados.
- El aparato debe conectarse a tierra.
- Asegúrese de que los parámetros de la placa de características son compatibles con los valores eléctricos del suministro eléctrico.
- Utilice siempre una toma con aislamiento de conexión a tierra correctamente instalada.
- No utilice adaptadores de enchufes múltiples ni cables prolongadores.
- Asegúrese de no provocar daños en el enchufe ni en el cable de red. Si es necesario cambiar el cable de

alimentación del aparato, debe hacerlo el centro de servicio técnico autorizado.

- Evite que el cable de red toque o entre en contacto con la puerta del aparato o con el hueco por debajo del aparato, especialmente mientras funciona o si la puerta está caliente.
- Los mecanismos de protección contra descargas eléctricas de componentes con corriente y aislados deben fijarse de forma que no puedan aflojarse sin utilizar herramientas.
- Conecte el enchufe a la toma de corriente únicamente cuando haya terminado la instalación. Asegúrese de tener acceso al enchufe del suministro de red una vez finalizada la instalación.
- Si la toma de corriente está floja, no conecte el enchufe.
- No desconecte el aparato tirando del cable de conexión a la red. Tire siempre del enchufe.
- Use únicamente dispositivos de aislamiento apropiados: línea con protección contra los cortocircuitos, fusibles (tipo tornillo que puedan retirarse del soporte), dispositivos de fuga a tierra y contactores.
- La instalación eléctrica debe tener un dispositivo de aislamiento que permita desconectar el aparato de todos los polos de la red. El dispositivo de aislamiento debe tener una apertura de contacto con una anchura mínima de 3 mm.
- Cierre completamente la puerta del aparato antes de enchufar el cable de alimentación a la toma de corriente.
- El aparato se suministra con enchufe y cable de red.

2.3 Uso

ADVERTENCIA!

Riesgo de lesiones, quemaduras y descargas eléctricas o explosiones.

- No cambie las especificaciones de este aparato.
- Asegúrese de que las aberturas de ventilación no están bloqueadas.
- No deje el aparato desatendido durante el funcionamiento.
- Apague el aparato después de cada uso.

- Tenga cuidado al abrir la puerta del aparato mientras funciona. Puede liberarse aire caliente.
- No utilice el aparato con las manos mojadas ni con agua en contacto.
- No ejerza presión sobre la puerta abierta.
- No utilice el aparato como superficie de trabajo ni para depositar objetos.
- Abra la puerta del aparato con cuidado. El uso de ingredientes con alcohol puede provocar una mezcla de alcohol y aire.
- No deje que los chispas ni las llamas abiertas entren en contacto con el aparato cuando abra la puerta.
- No coloque productos inflamables o artículos mojados con productos inflamables dentro, cerca o sobre el aparato.

⚠ ADVERTENCIA!

Riesgo de daños en el aparato.

- Para evitar daños o decoloraciones en el esmalte:
 - no coloque recipientes ni otros objetos directamente en la base.
 - no coloque papel de aluminio directamente en la parte inferior del interior del aparato.
 - no ponga agua directamente en el aparato caliente.
 - no deje platos húmedos ni alimentos en el aparato una vez finalizada la cocción.
 - tenga cuidado al retirar o instalar los accesorios.
- La pérdida de color del esmalte o el acero inoxidable no afecta al rendimiento del aparato.
- Utilice una bandeja honda para pasteles húmedos. Los jugos de las frutas provocan manchas permanentes.
- Cocina siempre con la puerta del aparato cerrada.
- Si el aparato se instala detrás de un panel de un mueble (por ejemplo una puerta) asegúrese de que la puerta nunca esté cerrada mientras funciona el aparato. El calor y la humedad pueden acumularse detrás de un panel del armario cerrado y provocar daños al aparato, el alojamiento o el suelo. No cierre del panel del armario hasta que el aparato se haya enfriado completamente después de su uso.

2.4 Mantenimiento y limpieza

⚠ ADVERTENCIA!

Riesgo de lesiones o de daños en el aparato.

- Antes de proceder con el mantenimiento, apague el aparato y desconecte el enchufe de la red.
- Asegúrese de que el aparato esté frío. Los paneles de cristal pueden romperse.
- Cambie inmediatamente los paneles de cristal de la puerta que estén dañados. Póngase en contacto con el servicio técnico autorizado.
- Tenga cuidado al desmontar la puerta del aparato. ¡La puerta es muy pesada!
- Limpie periódicamente el aparato para evitar el deterioro del material de la superficie.
- Limpie el aparato con un paño suave humedecido. Utilice solo detergentes neutros. No utilice productos abrasivos, estropajos duros, disolventes ni objetos de metal.
- Si utiliza aerosoles de limpieza para hornos, siga las instrucciones de seguridad del envase.

2.5 Limpieza Piroclítica

⚠ ADVERTENCIA!

Riesgo de lesiones / Incendios / Emisiones químicas (humos) en el modo pirolítico.

- Antes de realizar la limpieza pirolítica y el precalentamiento inicial, retire del interior del horno:
 - restos de comida, aceite o grasa o depósitos.
 - cualquier objeto extraíble (incluidos estantes, rieles laterales, etc., suministrados con el aparato), especialmente cualquier olla, sartén, bandeja, utensilio, etc. antiadherente.
- Lea atentamente todas las instrucciones de limpieza pirolítica.
- Mantenga a los menores alejados del aparato cuando se realiza la limpieza pirolítica. El aparato se calienta mucho y el aire caliente se expulsa por las salidas de ventilación delanteras.

- La limpieza pirolítica es una operación a alta temperatura que puede liberar humos de los residuos de cocción y de los materiales de fabricación, por lo que se recomienda a los consumidores:
 - proporcionar una buena ventilación durante y después de la limpieza pirolítica.
 - proporcionar una buena ventilación durante y después del precalentamiento inicial.
- No derrame ni aplique agua a la puerta del horno durante y después de la limpieza pirolítica para no provocar daños en los paneles de vidrio.
- Los humos emitidos por todos los hornos pirolíticos y residuos de cocción descritos no son dañinos para las personas, incluidos los niños o personas con problemas médicos.
- Mantenga las mascotas pequeñas alejadas del aparato durante y después de la limpieza pirolítica y precalentamiento inicial. Las mascotas pequeñas (especialmente las aves y los reptiles) pueden ser muy sensibles a los cambios de temperatura y los humos emitidos.
- Las superficies antiadherentes de recipientes, sartenes, bandejas, utensilios, etc., pueden dañarse por la alta temperatura pirolítica de todos los hornos pirolíticos y también pueden ser fuente de humos dañinos de baja intensidad.

2.6 Iluminación interna

ADVERTENCIA!

Riesgo de descarga eléctrica.

- En cuanto a la(s) bombilla(s) de este producto y las de repuesto vendidas por

separado: Estas bombillas están destinadas a soportar condiciones físicas extremas en los aparatos domésticos, como la temperatura, la vibración, la humedad, o están destinadas a señalar información sobre el estado de funcionamiento del aparato. No están destinadas a utilizarse en otras aplicaciones y no son adecuadas para la iluminación de estancias domésticas.

- Este producto contiene una fuente luminosa de la clase de eficiencia energética G.
- Utilice solo bombillas de las mismas características .

2.7 Asistencia técnica

- Para reparar el aparato, póngase en contacto con el centro de servicio autorizado.
- Utilice solamente piezas de recambio originales.

2.8 Eliminación

ADVERTENCIA!

Existe riesgo de lesiones o asfixia.

- Contacte con las autoridades locales para saber cómo desechar correctamente el aparato.
- Desconecte el aparato de la red.
- Corte el cable eléctrico cerca del aparato y deséchelo.
- Retire el pestillo de la puerta para evitar que los niños o las mascotas queden atrapados en el aparato.

3. DESCRIPCIÓN DEL PRODUCTO

3.1 Resumen general

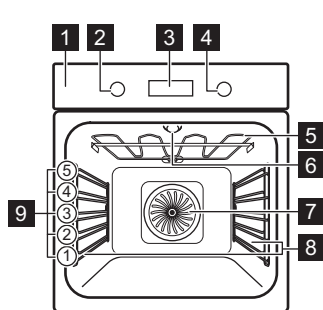

- 1 Panel de mandos
- 2 Mando de las funciones de cocción
- 3 Programador electrónico
- 4 Mando de control
- 5 Resistencia
- 6 Bombilla
- 7 Ventilador
- 8 Soporte de parrilla extraíble
- 9 Posiciones de las parrillas

3.2 Accesorios

Parrilla

Para utensilios de cocina, moldes de pastelería, asados.

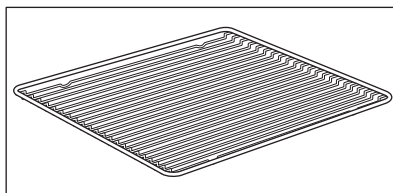

Bandeja

Para bizcochos y galletas.

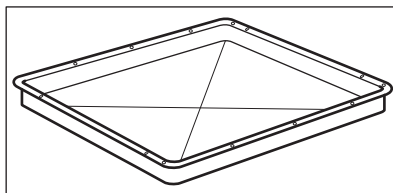

Parrilla/sartén para asar

Para hornear y asar o como bandeja para grasa.

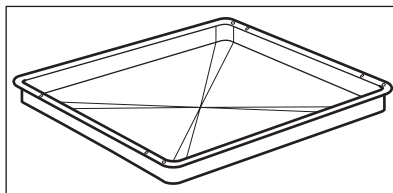

4. PANEL DE CONTROL

4.1 Mandos escamoteables

Para usar el aparato, presione el mando. El mando sale del alojamiento.

4.2 Vista general del panel de control

Seleccione una función de cocción para encender el aparato. Gire el mando de las

funciones de cocción hasta la posición de apagado para apagar el aparato.

				OK
Temporizador	Calentamiento rápido	Luz	Bloqueo	Confirmar ajuste

4.3 Pantalla

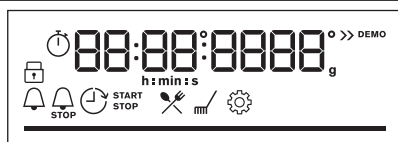

Pantalla con funciones principales.

Indicadores de pantalla

Indicadores básicos



Indicadores de temporizador

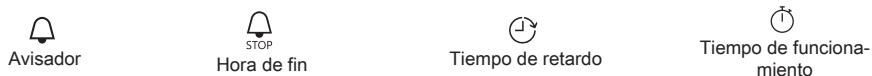

Barra de progreso - para la temperatura o el tiempo. La barra está completamente roja cuando el aparato alcanza la temperatura ajustada.



5. ANTES DEL PRIMER USO

ADVERTENCIA!

Consulte los capítulos sobre seguridad.

5.1 Limpieza inicial

Antes del primer uso, limpie el aparato vacío y ajuste el tiempo:





00:00

Ajuste la hora. Pulse OK.

5.2 Pre calentamiento inicial

Pre caliente el horno vacío antes de utilizarlo por primera vez.

Paso 1	Retire todos los accesorios del horno y carriles laterales extraíbles del horno.
Paso 2	Seleccione la temperatura máxima para la función:  Deje funcionar el horno 1h.
Paso 3	Seleccione la temperatura máxima para la función:  Deje funcionar el horno 15min.

 El horno puede emitir olores y humos durante el pre calentamiento. Asegúrese de que la sala esté ventilada.

6. USO DIARIO





ADVERTENCIA!





Consulte los capítulos sobre seguridad.

6.1 Cómo ajustar: Funciones de cocción

Paso 1	Gire el mando del horno y seleccione la función de cocción.
Paso 2	Gire el mando de control para ajustar la temperatura.

6.2 Funciones de cocción

Función de cocción	Aplicación
 Aire caliente	Para hornear en hasta tres posiciones de parrilla a la vez y para secar alimentos. Ajuste la temperatura entre 20 y 40 °C menos que para Cocción convencional.
 Cocción convencional	Para hornear y asar alimentos en una posición de parrilla.
 Congelados	Para conseguir que los alimentos precocinados queden crujientes; por ejemplo, patatas fritas, porciones de patata o rollitos de primavera.
 Función Pizza	Para hornear pizza. Para obtener un dorado más intenso y una base más crujiente.
 Calor inferior	Para hornear pasteles con base crujiente y conservar alimentos.

Función de cocción	Aplicación
 <p>Descongelar</p>	Para descongelar alimentos (verduras y frutas). El tiempo de descongelación depende de la cantidad y el tamaño de los alimentos congelados.
 <p>Horneado húmedo + ventilador</p>	Esta función está diseñada para ahorrar energía durante la cocción. Cuando se utiliza esta función, la temperatura interior del aparato puede diferir de la temperatura ajustada. Se utiliza el calor residual. La energía de calentamiento puede reducirse. Para obtener más información, consulte el capítulo "Uso diario", Notas sobre Horneado húmedo + ventilador.
 <p>Grill</p>	Para asar al grill alimentos de poco espesor y tostar pan.
 <p>Grill turbo</p>	Para asar con aire caliente piezas de carne más grandes o aves con hueso en un nivel de parrilla. Para gratinar y dorar.
 <p>Menú</p>	Para acceder al menú: Cocción asistida, Limpieza, Ajustes.

6.3 Notas sobre la función Moist Fan: Horneado húmedo + ventilador

Esta función se utilizaba para cumplir con los requisitos de eficiencia energética y diseño ecológico (según EU 65/2014 y EU 66/2014). Pruebas según: IEC/EN 60350-1.

La puerta del horno debe estar cerrada durante la cocción para que no se interrumpa la función y el horno funcione con la máxima eficiencia energética posible.

Cuando se utiliza esta función, la lámpara se apaga automáticamente después de 30 s.







Consulte las instrucciones de cocción en el capítulo "Consejos", Horneado húmedo + ventilador. Para recomendaciones generales sobre ahorro energético, consulte el capítulo "Eficiencia energética", Ahorro energético.

6.4 Cómo ajustar: Cocción asistida

Para cada plato de este submenú se recomienda una función de cocción y una temperatura. Utilice la función para preparar un plato rápidamente con los ajustes predeterminados. Puede ajustar la hora y la temperatura durante la cocción.

Cuando termine la función, compruebe si la comida está lista.

Para algunos de los platos, también puede cocinar con: • Peso automático

Paso 1	Paso 2	Paso 3	Paso 4
			
		<p>P1 - P...</p>	<p>OK</p>

Acceda al menú.

Seleccione Cocción asistida. Pulse **OK**.

Seleccione el plato. Pulse **OK**.

Introduzca el plato en el horno. Confirmar ajuste.

6.5 Cocción asistida

Leyenda



Peso automático disponible.

Leyenda













































Precaliente el aparato antes de empezar a cocinar.



Nivel del estante.





Plato	Peso	Nivel/accesorio de la parrilla
P1 Rosbif, poco hecho		2 bandeja de hornear
P2 Rosbif, al punto	1 - 1.5 kg; 4-5 pedazos gruesos cm	Fría la carne durante unos minutos en una sartén caliente. Insértelo en el aparato.
P3 Rosbif, muy hecho		
P4 Bistec, en su punto	180 - 220 g por pedazo; 3 rebanadas gruesas cm	3 fuente de asado encendida parrilla Fría la carne durante unos minutos en una sartén caliente. Insértelo en el aparato.
P5 Asado de ternera/ estofado (costillas de cebado, redondo superior, flanco grueso)	1.5 - 2 kg	2 fuente de asado encendida parrilla Fría la carne durante unos minutos en una sartén caliente. Añada líquido. Insértelo en el aparato.
P6 Rosbif, poco hecho (cocción lenta)		2; bandeja
P7 Rosbif, al punto (cocción lenta)	1 - 1.5 kg; 4-5 pedazos gruesos cm	Use sus condimentos favoritos o simplemente sal y pimienta con molinda fresca. Fría la carne durante unos minutos en una sartén caliente. Insértelo en el aparato.
P8 Rosbif, muy hecho (cocción lenta)		
P9 Filete de ternera, poco hecho (cocción lenta)		2 bandeja de hornear
P10 Filete de ternera, en su punto (cocción lenta)	0,5 - 1,5 kg; 5 - 6 pedazos gruesos cm	Use sus condimentos favoritos o simplemente sal y pimienta con molinda fresca. Fría la carne durante unos minutos en una sartén caliente. Insértelo en el aparato.
P11 Filete de ternera, hecho (cocción lenta)		
P12 Asado de ternera (por ejemplo, el hombro)	0.8 - 1.5 kg; 4- pedazos gruesos cm	2 fuente de asado encendida parrilla Use sus especias favoritas. Añada líquido. Asado cubierto.
P13 Cerdo asado en el cuello o en el hombro	1.5 - 2 kg	2 fuente de asado encendida parrilla Después de la mitad del tiempo de cocción, voltee la carne.

	Plato	Peso	Nivel/accesorio de la parrilla
P14	Cerdo desmigado (cocción lenta)	1.5 - 2 kg	 2 bandeja de hornear Use sus especias favoritas. Dé la vuelta a la carne a la mitad del tiempo de cocción para dorar uniformemente.
P15	Lomo de cerdo fresco	1 - 1.5 kg; 5-6 pedazos gruesos cm	 2; fuente de asado en laparrilla Use sus especias favoritas.
P16	Costillas de cerdo de repuesto	2 - 3 kg; utilice 2-3 costillas finas cm	 3 bandeja honda Añada líquido para cubrir la base de un plato. Después de la mitad del tiempo de cocción, voltee la carne.
P17	Pierna de cordero con hueso	1.5 - 2 kg; 7-9 pedazos gruesos cm	 2; fuente de asado en la bandeja Añada líquido. Después de la mitad del tiempo de cocción, voltee la carne.
P18	Pollo entero	1 - 1.5 kg; fresco	  2; cazuela sobre bandeja Use sus especias favoritas. Dele la vuelta al pollo a la mitad del tiempo de cocción para obtener un dorado uniforme.
P19	Medio pollo	0.5 - 0.8 kg	 3 bandeja de hornear Use sus especias favoritas.
P20	Pechuga de pollo	180 - 200 g por trozo	  2 cazuela sobre parrilla Use sus especias favoritas. Fría la carne durante unos minutos en una sartén caliente.
P21	Muslos de pollo, frescos	-	 3 bandeja de hornear Si se marchan las patas de pollo marinadas, ajuste la temperatura más baja y cocínelas más tiempo.
P22	Pato entero	2 - 3 kg	  2 fuente de asado encendida parrilla Use sus especias favoritas. Coloque la carne en la fuente. Dé la vuelta al pato a la mitad del tiempo de cocción.
P23	Ganso entero	4 - 5 kg	  2; bandeja honda Use sus especias favoritas. Coloque la carne en la bandeja honda. Dele la vuelta a la mitad del tiempo de cocción.
P24	Pastel de carne	1 kg	 2; parrilla Use sus especias favoritas.
P25	Pescado entero, al grill	0.5 - 1 kg por pescado	 2 bandeja de hornear Llene el pescado con mantequilla y utilice sus especias y hierbas favoritas.
P26	Filete de pescado	-	  3 cazuela sobre parrilla Use sus especias favoritas.
P27	Tarta de queso	-	 2;  28 cm molde desmontable en la bandeja de rejilla

	Plato	Peso	Nivel/accesorio de la parrilla
P28	Tarta de manzana	-	 3; bandeja
P29	Tarta de manzana	-	 2; forma de pastel en la parrilla
P30	Pastel de manzana	-	 1;  22 cm molde con forma de tarta en la bandeja de rejilla
P31	Brownies	2 kg de masa	 3 bandeja honda
P32	Magdalenas de chocolate	-	 3 bandeja para magdalenas encendida parrilla
P33	Pastel de hogaza	-	 2; molde de pan en la parrilla
P34	Patatas al horno	1 kg	 2; bandeja Ponga las patatas enteras con piel en la bandeja.
P35	Porciones	1 kg	 3 bandeja de hornear forrado con papel de hornear Use sus especias favoritas. Corte las patatas en trozos.
P36	Verduras al grill	1 - 1.5 kg	 3 bandeja de hornear forrado con papel de hornear Use sus especias favoritas. Corte las verduras en trozos.
P37	Croquetas, congeladas	0.5 kg	 3; bandeja
P38	Pomos congelados	0.75 kg	 3; bandeja
P39	Lasaña de carne/verdura con láminas de pasta seca	1 - 1.5 kg	 2; cazuela sobre parrilla
P40	Patatas gratinadas (patatas crudas)	1 - 1.5 kg	 1; cazuela sobre parrilla Gire el plato transcurrida la mitad del tiempo de cocción.
P41	Pizza fresca y fina	-	  2; bandeja forrada con papel de hornear
P42	Pizza fresca, gruesa	-	  2; bandeja forrada con papel de hornear
P43	Quiche	-	 2; molde de hornear en la parrilla
P44	Baguette / chapata / pan blanco	0.8 kg	  2; bandeja forrada con papel de hornear Se necesita más tiempo para el pan blanco.
P45	Pan integral / centeno / pan oscuro	1 kg	  2; bandeja para hornear forrada con papel de hornear/ molde para pan en la bandeja de rejilla

7. FUNCIONES DEL RELOJ

7.1 Funciones de reloj





Función de reloj	Aplicación
 Avisador	Al finalizar el tiempo, sonará la señal acústica.
 Tiempo de cocción	Cuando el temporizador finaliza, suena la señal y la función de cocción se detiene.
 Tiempo de retardo	Para posponer el inicio y/o fin de la cocción.
 Tiempo de funcionamiento	El máximo es 23 h 59 min. Esta función no influye en el funcionamiento del horno. Para encender y apagar el Tiempo de funcionamiento seleccione: Menú, Ajustes.

7.2 Cómo ajustar: Funciones de reloj

Cómo ajustar: Hora

Paso 1	Paso 2	Paso 3
		
Para cambiar la hora, acceda al menú y seleccione Ajustes, Hora.	Ajuste el reloj	Pulse: OK .

Cómo ajustar: Avisador

Paso 1		Paso 2	Paso 3
	La pantalla muestra: 0:00 		
Pulse: 		Ajustar la Avisador	Pulse: OK .

 El temporizador comienza la cuenta atrás inmediatamente.

Cómo ajustar: Tiempo de cocción

Paso 1



Elija una función de cocción y la temperatura.

Paso 2



Pulse repetidamente:



La pantalla mues-

tra:
0:00



Paso 3



Ajuste el tiempo de cocción.

Paso 4



Pulse: OK.

El temporizador comienza la cuenta atrás inmediatamente.

Cómo ajustar: Tiempo de retardo

Paso 1



Seleccione la función de cocción.

Paso 2



Pulse repetidamente:



Paso 3



La pantalla muestra: la hora



INICIO

Ajuste la hora de inicio.

Paso 4



Pulse: OK.

Paso 5



La pantalla muestra: --:--



PARAR

Ajuste la hora de fin.

Paso 6



Pulse: OK.

El temporizador empieza a contar hacia atrás a una hora programada.

8. USO DE LOS ACCESORIOS

ADVERTENCIA!

Consulte los capítulos sobre seguridad.

8.1 Inserción de accesorios

Una pequeña muesca en la parte superior aumenta la seguridad. Las hendiduras

también son dispositivos antivuelco. El borde elevado que rodea la bandeja evita que los utensilios de cocina resbalen de la parrilla.

Parrilla:

Inserte la parrilla entre las guías del carril.

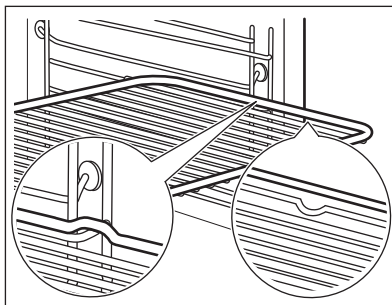
**Bandeja / Bandeja honda:**

Introduzca la bandeja entre las guías del carril de apoyo.

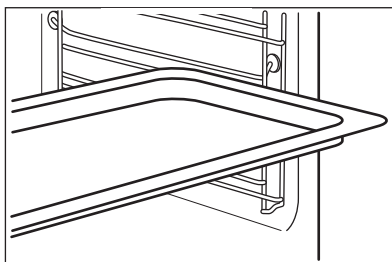

9. FUNCIONES ADICIONALES

9.1 Bloqueo

Esta función impide que se produzca accidentalmente un cambio en la función del aparato.

Actívela cuando el aparato esté en funcionamiento: la cocción ajustada continúa y el panel de control está bloqueado.

Actívela cuando el aparato esté apagado: no se puede encender y el panel de control está bloqueado.



- mantenga pulsado para activar la función.
Suena una señal.



- mantenga pulsado para apagarla.

3 x - parpadea cuando se enciende el bloqueo.

9.2 Desconexión automática

Por razones de seguridad, si la función de cocción está activa y no se cambia ningún ajuste, el aparato se apagará automáticamente tras un determinado periodo de tiempo.

🌡️ (°C)	⌚ (h)
30 - 115	12.5
120 - 195	8.5
200 - 245	5.5

 (°C)

250 - máximo

 (h)

3

El apagado automático no funciona con las funciones: Luz, Tiempo de retardo.

9.3 Ventilador de refrigeración

Cuando el aparato está en funcionamiento, el ventilador de enfriamiento se enciende automáticamente para mantener frías sus superficies. Si apaga el aparato, el ventilador de enfriamiento puede seguir funcionando hasta que se enfríe.

10. CONSEJOS

10.1 Recomendaciones de cocción





La temperatura y los tiempos de cocción de las tablas son meramente orientativos. Dependen de las recetas y de la calidad y cantidad de los ingredientes utilizados.

El aparato puede hornear o asar de forma diferente del aparato que tenía anteriormente. Las siguientes sugerencias muestran los ajustes recomendados para la temperatura, el tiempo de cocción y la posición de los estantes para tipos de alimentos concretos.

Si no encuentra los ajustes para una receta especial, busque otra similar.

10.2 Horneado húmedo + ventilador

Para obtener el mejor resultado, siga las recomendaciones de la tabla siguiente.

	°C		
Pasta gratinada	200 - 220	45 - 55	3
Patatas gratinadas	180 - 200	70 - 85	3
Moussaka	170 - 190	70 - 95	3
Lasaña	180 - 200	75 - 90	3
Canelones	180 - 200	70 - 85	3
Pudding de pan	190 - 200	55 - 70	3
Arroz	170 - 190	45 - 60	3
Tarta de manzana, hecha con mezcla de bizcocho (molde redondo)	160 - 170	70 - 80	3
Pan blanco	190 - 200	55 - 70	3

10.3 Horneado húmedo + ventilador - accesorios recomendados

Utilice molde y recipientes oscuros y mates. Tiene mejor absorción del calor que los platos de color claro y brillantes.



Bandeja para pizza

Oscuro, mate
28 cm de diámetro

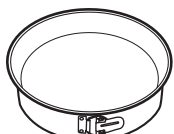

Bandeja para hornear

Oscuro, mate
26 cm de diámetro



Ramequines

Cerámica
8 cm de diámetro,
5 cm de altura

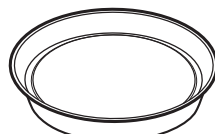

Molde para base





Oscuro, mate
28 cm de diámetro

10.4 Tablas de cocción para organismos de control

Información para institutos de pruebas





Pruebas según: EN 60350, IEC 60350.

Horneado en un nivel: hornear en moldes





		 °C	 min	
Bizcocho sin grasa	Aire caliente	160	45 - 60	2
Bizcocho sin grasa	Cocción convencional	160	45 - 60	2
Tarta de manzana, 2 moldes, Ø 20 cm	Aire caliente	160	55 - 65	2
Tarta de manzana, 2 moldes, Ø 20 cm	Cocción convencional	180	55 - 65	1
Mantecados	Aire caliente	140	25 - 35	2
Mantecados	Cocción convencional	140	25 - 35	2

Horneado en un nivel: galletas

Use el tercer nivel.

		 °C	 min
Pastelillos, 20 unidades por bandeja, precaliente el horno vacío	Aire caliente	150	20 - 30
Pastelillos, 20 unidades por bandeja, precaliente el horno vacío	Cocción convencional	170	20 - 30





Horneado multinivel: galletas

		 °C	 min	
Mantecados	Aire caliente	140	25 - 45	2 / 4
Pastelillos, 20 unidades por bandeja, precaliente el horno vacío	Aire caliente	150	25 - 35	1 / 4
Bizcocho sin grasa	Aire caliente	160	45 - 55	2 / 4
Pastel de manzana, 1 molde por rejilla (Ø 20 cm)	Aire caliente	160	55 - 65	2 / 4

Grill

Precaliente el horno vacío durante 5 minutos.

Grill con la temperatura ajustada al máximo.

		 min	
Tostadas	Grill	1 - 2	5
Bistec de vacuno, dar la vuelta a media cocción	Grill	24 - 30	4

11. MANTENIMIENTO Y LIMPIEZA

ADVERTENCIA!

Consulte los capítulos sobre seguridad.

11.1 Notas sobre la limpieza



Agentes limpiadores

Limpie la parte frontal del aparato solo con un paño de microfibra humedecido en agua tibia y detergente suave.

Utilice un producto de limpieza para limpiar las superficies metálicas.

Limpie las manchas con un detergente suave.



Uso diario

Limpie el interior después de cada uso. La acumulación de grasa u otros residuos puede provocar un incendio.

No guarde la comida en el aparato más de 20 minutos. Seque la cavidad solo con un paño de microfibra después de cada uso.



Limpie todos los accesorios después de cada uso y déjelos secar. Use solo un paño suave humedecido en agua tibia y detergente suave. No lave los accesorios en el lavavajillas.

Evite limpiar los accesorios antiadherentes con limpiadores abrasivos u objetos afilados.

Accesorios

11.2 Cómo quitar: Carriles de apoyo

Para limpiar el horno, retire los carriles de apoyo.

Paso 1 Apague el horno y espere a que esté frío.

Paso 2 Tire de la parte delantera del carril de apoyo para separarlo de la pared lateral.

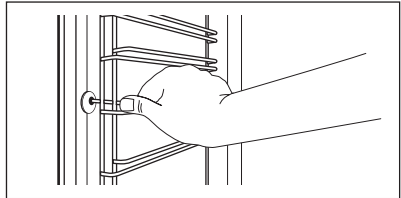

Paso 3 Tire del extremo trasero del carril de apoyo para separarlo de la pared y extráigalo.

Paso 4 Instale los carriles de apoyo en el orden inverso.

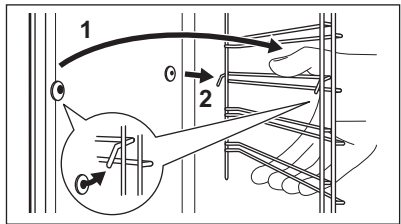

11.3 Instrucciones de uso: Limpieza pirolítica

Limpie el horno con Limpieza pirolítica.

⚠ ADVERTENCIA!

Existe riesgo de quemaduras.

⚠ PRECAUCIÓN!

Si hay otros aparatos instalados en el mismo armario, no los utilice al mismo tiempo que esta función. El horno podría dañarse.

Antes de Limpieza pirolítica:

Apague el horno y espere a que esté frío.

Retire todos los accesorios del horno y carriles laterales extraíbles.

Limpie el suelo del horno y la puerta interior de cristal con agua templada, un paño suave y detergente suave.

Limpieza pirolítica

Paso 1

Acceda al menú: Limpieza m^{f} .

Opción

Duración

Limpeza pirolítica

C1 - Limpeza ligera	1 h
C2 - Limpeza normal	1 h 30 min
C3 - Limpeza a fondo	3 h

- Paso 2** OK: pulse para seleccionar el programa de limpieza.
- Paso 3** OK - pulse para comenzar la limpieza.
- Paso 4** Tras la limpieza, gire el mando de las funciones de cocción hasta la posición de apagado.

i Cuando comienza la limpieza, se bloquea la puerta del horno y se apaga la bombilla. Hasta que la puerta se abra, la pantalla mostrará: .

Cuando termina la limpieza:

Apague el horno y espere a que esté frío. Seque el interior con un paño suave. Retire los residuos de la parte inferior del interior.

11.4 Aviso de limpieza

El horno le recuerda que debe limpiarlo con la limpieza pirolítica.

 parpadea en la pantalla durante 5 segundos después de cada sesión de cocción.

Para desactivar el aviso, pulse la tecla Menú y seleccione Ajustes, Aviso de limpieza.

11.5 Cómo quitar e instalar: Puerta

Es posible retirar la puerta del horno y los paneles de cristal interiores para limpiarlos. El número de paneles de cristal es diferente según los modelos.

! ADVERTENCIA!

La puerta es pesada.

! PRECAUCIÓN!

Maneje con cuidado el cristal, especialmente alrededor de los bordes del panel frontal. El cristal puede romperse.

- Paso 1** Abra la puerta por completo.
- Paso 2** Levante y presione al máximo las palancas de bloqueo (A) de ambas bisagras de la puerta.

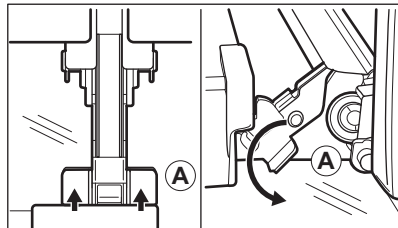

Paso 3 Cierre la puerta del horno hasta la primera posición de apertura (aproximadamente a un ángulo de 70°). Sostenga la puerta con una mano a cada lado y tire de ella hacia arriba y hacia afuera. Ponga la puerta con el lado exterior hacia abajo sobre un paño suave en una superficie nivelada.

Paso 4 Sujete el marco de la puerta (B) por el borde superior de la puerta por ambos lados y empuje hacia dentro para soltar el cierre.

Paso 5 Tire del borde del acabado de la puerta hacia delante para desengancharla.

Paso 6 Sujete uno tras otro los paneles de cristal de la puerta por su borde superior y extráigalos de la guía.

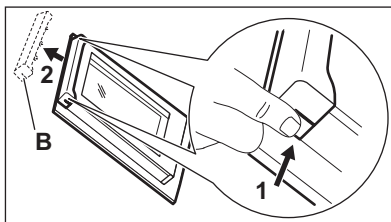

Paso 7 Limpie el panel de cristal con agua y jabón. Seque el panel de cristal con cuidado. No limpie los paneles de cristal en el lavavajillas.

Paso 8 Tras la limpieza, lleve a cabo los pasos anteriores en orden inverso.

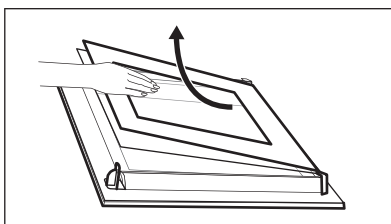

Paso 9 Introduzca primero el panel más pequeño y luego el de mayor tamaño y la puerta.

11.6 Cómo cambiar: Bombilla



ADVERTENCIA!

Riesgo de descarga eléctrica.
La lámpara puede estar caliente.

Antes de reemplazar la bombilla:

Paso 1

Apague el horno. Espere hasta que el horno esté frío.

Paso 2

Desconecte el horno de la red.

Paso 3

Coloque un paño en el fondo de la cavidad.

Bombilla superior

Paso 1 Gire la tapa de cristal para extraerla.

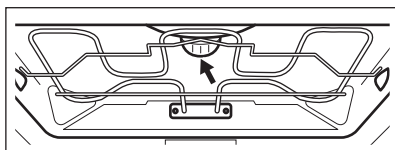

Paso 2 Limpie la tapa de cristal.

Paso 3 Cambie la bombilla por otra apropiada termorresistente hasta 300 °C.

Paso 4 Instale la tapa de cristal.

12. SOLUCIÓN DE PROBLEMAS

ADVERTENCIA!

Consulte los capítulos sobre seguridad.

12.1 Qué hacer si...

En cualquier caso no incluido en esta tabla, por favor contacte con un Centro de Servicio Autorizado.



El aparato no se enciende o no se calienta

Problema	Compruebe que...
No se puede encender ni utilizar el aparato.	El aparato está bien conectado a la red eléctrica.
El aparato no se calienta.	El apagado automático está desactivado.
El aparato no se calienta.	La puerta del aparato está cerrada.
El aparato no se calienta.	No ha saltado el fusible.
El aparato no se calienta.	El icono del candado está apagado.



Componentes

Problema	Compruebe que...
La bombilla está apagada.	Horneado húmedo + ventilador - está encendido.
La bombilla no funciona.	La bombilla se ha fundido.



Código de error

La pantalla muestra...	Compruebe que...
Err C3	La puerta del aparato está cerrada o el cierre de la puerta no está roto.
Err F102	La puerta del aparato está cerrada.
Err F102	El cierre de la puerta no está roto.
00:00	Se ha producido un corte de corriente. Ajuste la hora.

Si la pantalla muestra un código de error que no está en esta tabla, apague y encienda el fusible de la vivienda para reiniciar el aparato. Si el código de error se repite, contacte con un Centro de servicio autorizado.

12.2 Datos de servicio

Si no logra subsanar el problema, póngase en contacto con su distribuidor o un centro de servicio técnico autorizado.

Los datos que necesita para el Centro de servicio técnico se encuentran en la placa de características. La placa de características se encuentra en el marco delantero del interior del aparato. No retire la placa de características de la cavidad del aparato.

Se recomienda escribir los datos aquí:

Modelo (MOD):
Número de producto (PNC)
Número de serie (S.N.)

13. EFICACIA ENERGÉTICA

13.1 Información del producto y ficha de información del producto conforme a la normativa de la UE sobre etiquetado energético y diseño ecológico

Nombre del proveedor	AEG
Identificación del modelo	BPK535060B 944188596 BPK535060M 944188597
Índice de eficiencia energética	81.2
Clase de eficiencia energética	A+
Consumo de energía con una carga estándar, modo convencional	1.09 kWh/ciclo
Consumo de energía con una carga estándar, modo de ventilador forzado	0.69 kWh/ciclo
Número de cavidades	1
Fuente de energía	Electricidad
Volumen	71 l
Tipo de horno	Horno empotrable
Masa	BPK535060B 35.0 kg
	BPK535060M 35.0 kg

IEC/EN 60350-1 - Aparatos electrodomésticos de cocción - Parte 1: Cocinas, hornos, hornos de vapor y grills - Métodos de medida del rendimiento.

13.2 Ahorro energético



El aparato tiene características que le ayudan a ahorrar energía durante la cocina de cada día.

Asegúrese de que la puerta del aparato esté cerrada cuando esté en funcionamiento. No

abra la puerta del aparato muchas veces durante la cocción. Mantenga limpia la junta de la puerta y asegúrese de que está bien fijada en su posición.

Utilice utensilios de cocina de metal para mejorar el ahorro energético.

No precaliente el aparato antes de cocinar en la medida de lo posible.

Reduzca al máximo el tiempo entre horneados cuando prepare varios platos de una vez.

Cocción con ventilador

En la medida de lo posible, utilice las funciones de cocción con ventilador para ahorrar energía.

Calor residual

La bombilla y el ventilador siguen funcionando. Al apagar el aparato la pantalla mostrará el calor residual. El calor puede emplearse para mantener caliente los alimentos.

Para una duración de la cocción superior a 30 minutos, reduzca la temperatura del aparato un mínimo de 3 a 10 minutos antes de llegar al final de la cocción. El calor residual dentro del aparato hará que la comida se siga cocinando.

Utilice el calor residual para calentar otros platos.

Mantener calientes los alimentos

Si desea utilizar el calor residual para mantener calientes los alimentos, seleccione el ajuste de temperatura más bajo posible. El indicador de calor residual o la temperatura aparecen en la pantalla.

Cocción con la bombilla apagada

Apague la luz mientras cocina. Enciéndala únicamente cuando la necesite.



Horneado húmedo + ventilador

Función diseñada para ahorrar energía durante la cocción.

Cuando utilice esta función, la lámpara se apagará automáticamente después de 30 segundos. Puede volver a encender la luz, pero de este modo reducirá el ahorro energético esperado.

14. ESTRUCTURA DEL MENÚ

14.1 Menú

Paso 1	Paso 2	Paso 3	Paso 4	Paso 5
				
 - seleccione para acceder al Menú.	Seleccione la opción de la estructura Menú y pulse OK .	Seleccione el ajuste.	OK : pulse para confirmar el ajuste.	Ajuste el valor y pulse OK .

Gire el mando de las funciones de cocción hasta la posición de apagado para salir de Menú.

Menú estructura

Cocción asistida 

Limpieza 

Ajustes 

Ajustes

01	Hora	Cambiar	02	Brillo de la pantalla	1 - 5
03	Tono de teclas	1 - Pitido 2 - Haga clic 3 - Sonido apagado	04	Volumen del timbre	1 - 4

Ajustes

05	Tiempo de funcionamiento	Encendido/ Apagado	06	Luz	Encendido/Apaga- do
07	Calentamiento rápido	Encendido/ Apagado	08	Aviso de limpieza	Encendido/Apaga- do
09	Modo demostración	Código de acti- vación. 2468	10	Versión del software	Comprobar
11	Restaurar todos los ajustes	Sí / No			

15. ASPECTOS MEDIOAMBIENTALES

Recicle los materiales con el símbolo . Coloque el material de embalaje en los contenedores adecuados para su reciclaje. Ayude a proteger el medio ambiente y la salud pública, así como a reciclar residuos de aparatos eléctricos y electrónicos. No

deseche los aparatos marcados con el símbolo  junto con los residuos domésticos. Lleve el producto a su centro de reciclaje local o póngase en contacto con su oficina municipal.





aeg.com

867371228-D-372023



CE