

El Corte Inglés

Futbolín plegable

JÓVENES LEYENDAS

Matraquilhos desdobráveis Jovens lendas

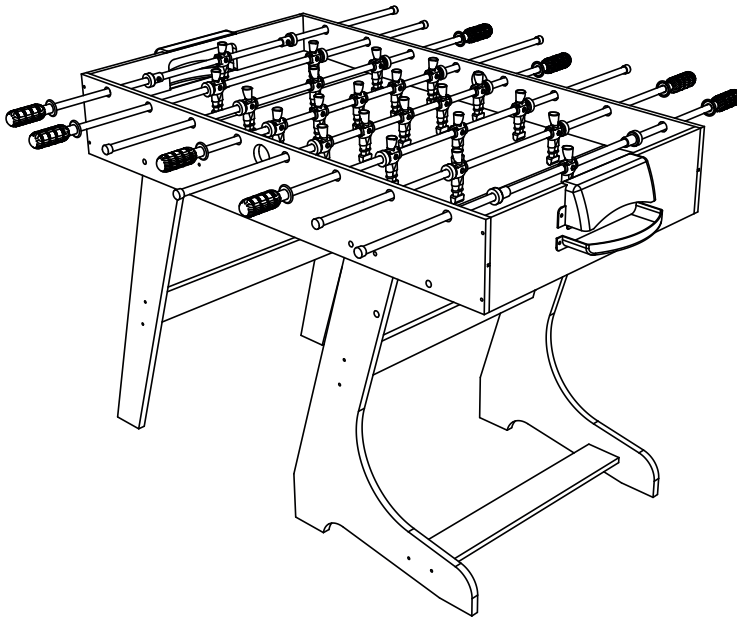

6+



Ref.: XR-ST5065

INSTRUCCIONES INSTRUÇÕES

Guardar este manual de instrucciones para posibles consultas futuras.
Conservar as instruções para referência no futuro.









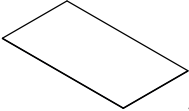
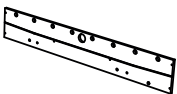
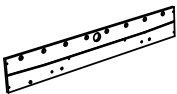
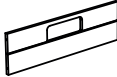
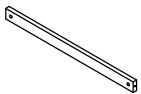

ES

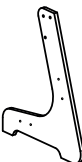
ADVERTENCIAS DE SEGURIDAD

ADVERTENCIA: No conviene para niños menores de 36 meses. Piezas pequeñas. Bolas pequeñas. Peligro de atragantamiento.

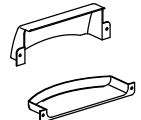
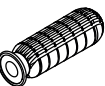
Advertencias: Los colores y contenidos pueden ser diferentes de los ilustrados. Retire el envoltorio, bolsas, bridas y alambres antes de dar el juguete al niño. El montaje debe realizarlo un adulto. Utilizar bajo la supervisión de un adulto.

LISTA DE PIEZAS

1  x1 Campo de juego / Campo de jogo.	2  x1 Panel largo 1 / Painel largo 1.	3  x1 Panel largo 2 / Painel largo 2.	4  x2 Panel corto / Painéis curtos.
5  x2 Soporte del campo de juego / Suporte do campo de jogo.	6  x3 Traviesas para patas / Vigas transversais para pernas.	7  Pata 1 / Perna 1.	8  Pata 2 / Perna 2.
9  Pata 3 / Perna 3.	10  Pata 4 / Perna 4.	11  x2 Porteria / Golo.	12  x8 Empuñadura / Manipulo.
13  x16 Amortiguador / Amortecedor.	14  x16 Arandela de plástico / Anilha de plástico.	15  x8 Protector para barra / Proteção para barra.	16  x4 Tope para barra / Anilha de bloqueio.

PT

ADVERTÊNCIAS DE SEGURANÇA













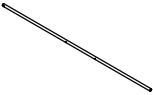
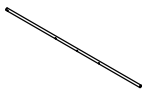
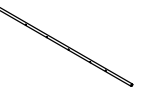
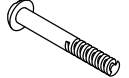

ATENÇÃO: Contra-indicado para crianças com menos de 36 meses. Pequenas partes. Pequenas bolas. Risco de engasgamento.

Atenção: As cores e os conteúdos podem diferir das imagens apresentadas. Remova a embalagem, bolsas, braçadeiras e fios antes de dar o brinquedo à criança. A montagem deve ser feita por uma pessoa adulta. Utilizar sob a supervisão de um adulto.

LISTA DE PEÇAS

ES

PT

17  x11 Jugadores equipo 1 / Jogadores equipa 1.	18  x11 Jugadores equipo 2 / Jogadores equipa 2.	19  x2 Barra 2 jugadores / jogadores.	20  x4 Barra 3 jugadores / jogadores.
21  x2 Barra 5 jugadores / jogadores.	22  x26 Perno / Cavilha.	23  x2 Balón / Bola.	24  x26 Tuerca / Noz.
25  x8 Perno / Cavilha 36 mm.	26  x1 Llave Allen / Chave Allen.	27  x8 Arandela / Arruela 5/6".	28  x8 Tornillo / Parafuso 45 mm.
29  x4 Tornillo / Parafuso 38 mm.	30  x8 Tornillo / Parafuso 12 mm.	31  x12 Tuerca / Noz 1/4".	32  x12 Perno / Cavilha 35 mm.
33  x12 Arandela / Arruela.			

1:

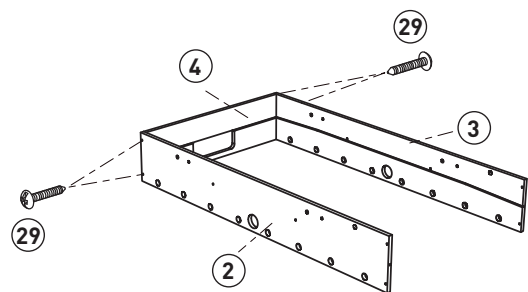

2:

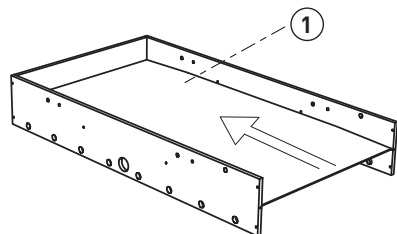

3:

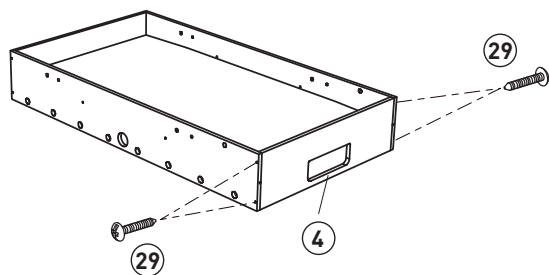

4:

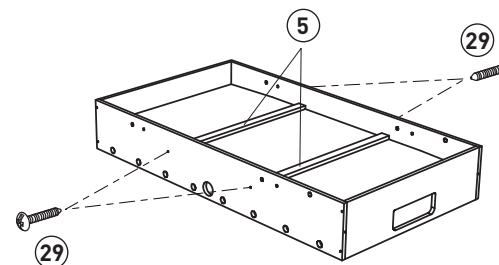

5:

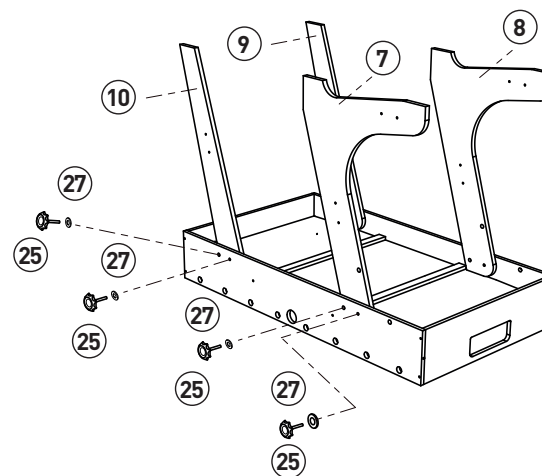

6:

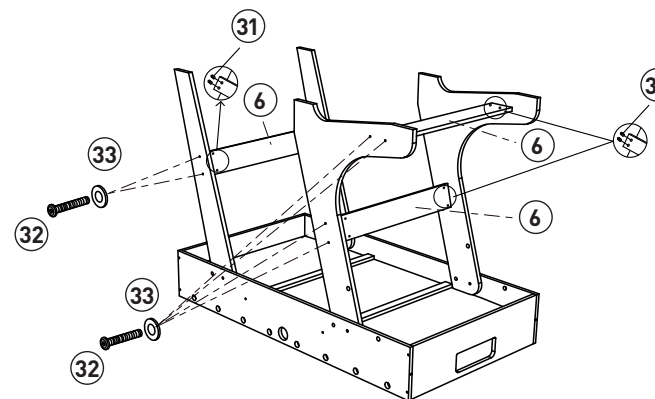

7:

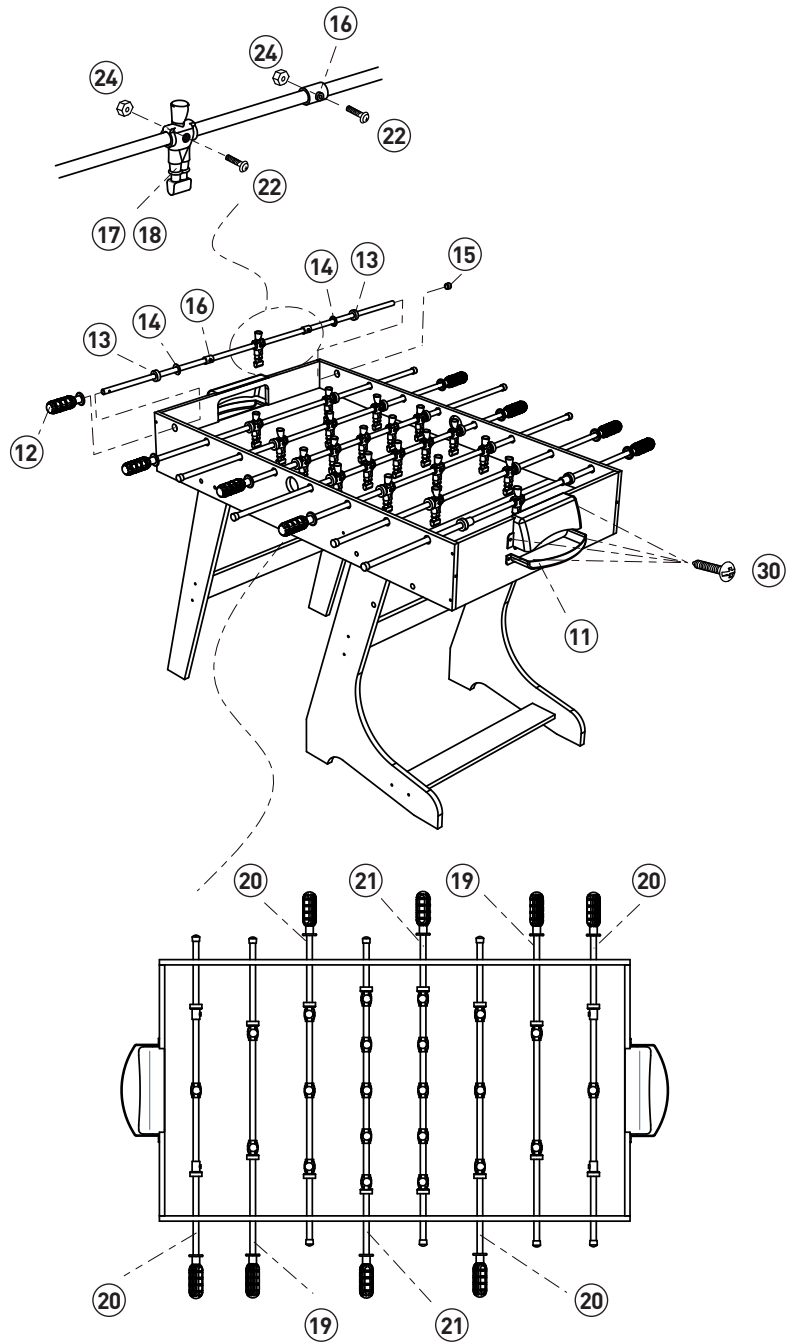

8:

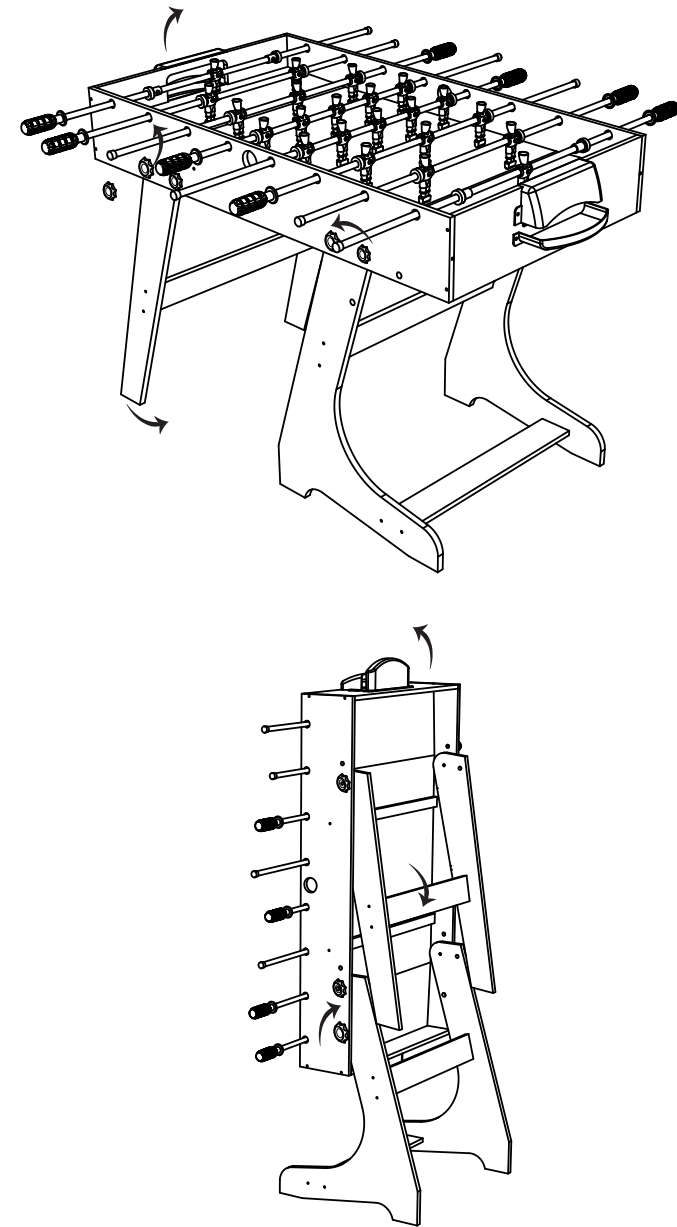



El Corte Inglés, S. A.
Hermosilla, 112 - 28009 Madrid
España / Espanha · NIF: A-28017895.
Fabricado en / na China.

Ref.: XR-ST5065