

# 250 x 110 x 50 cm

## 98.4" x 43.3" x 19.6"

### SIMONCLICK SUPERPLUS 6/500

**5** Años Garantía  
Years Guarantee  
Jahre Garantie  
Ans Garantie  
Anos de Garantía  
**SIMONRACK**



**1200 kg**  
(2645 lb)  
**Total**



\*MEDIDAS EN USO / USED MEASUREMENTS  
MASSNAHMEN IM EINSATZ / MEASURES IN EMPLOY / MEDIDAS EN USO:  
2510 x 1110 x 510 mm ( 98.8" x 43.7" x 20.1")



ESTANTERIAS SIMON S.L. B.60.556.463  
PG. ALFAMEN C/ POLIGONO C, N°3  
ALFAMEN (ZARAGOZA)



[www.simonrack.com](http://www.simonrack.com)



**Simon Rack**  
SINCE 1964 - MANUFACTURER



**INSTRUCTIONS**

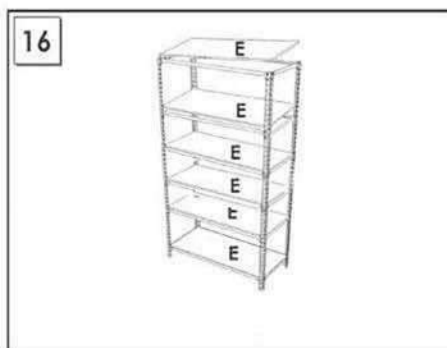
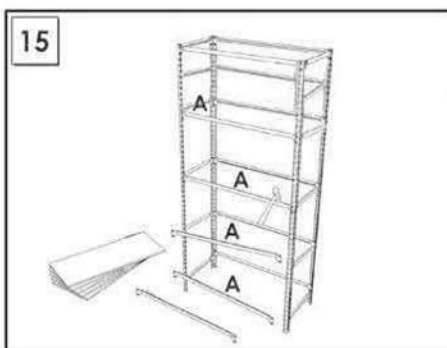
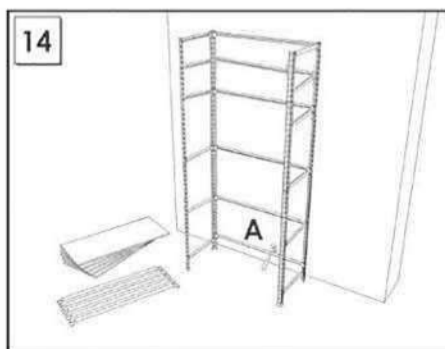
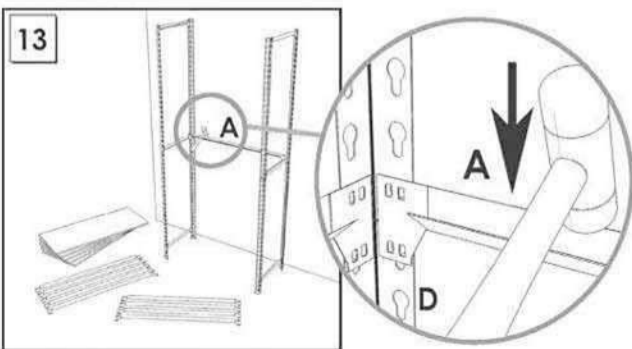
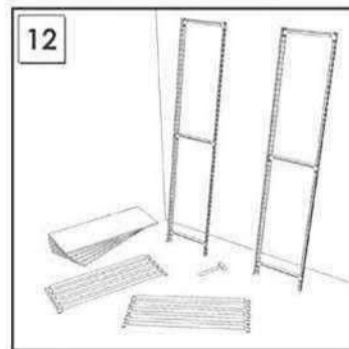
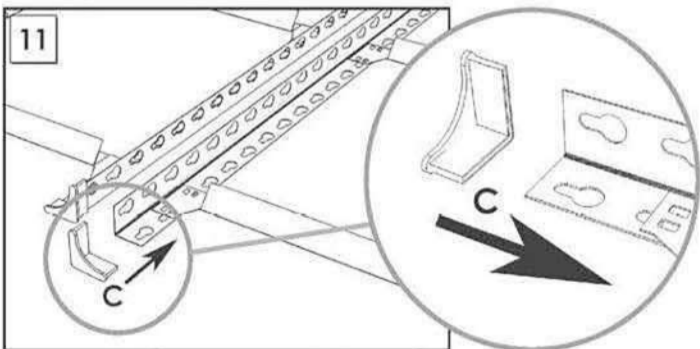
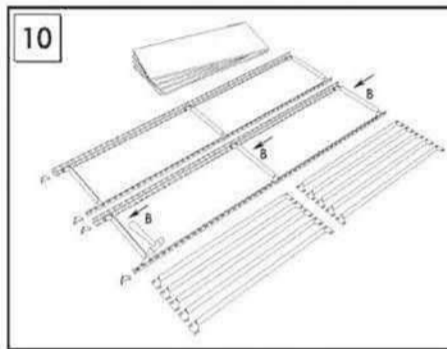
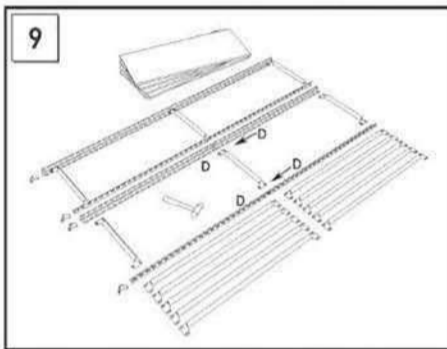
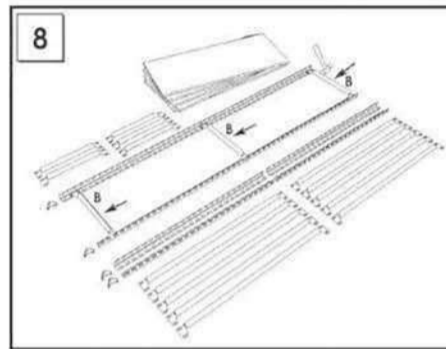
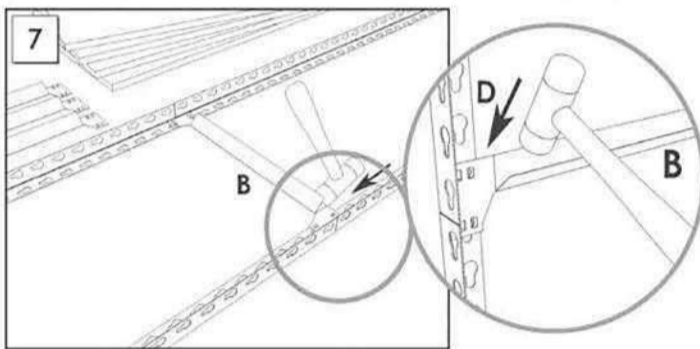
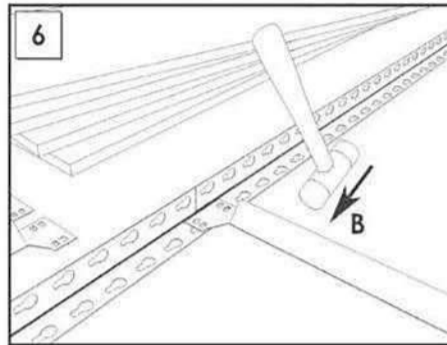
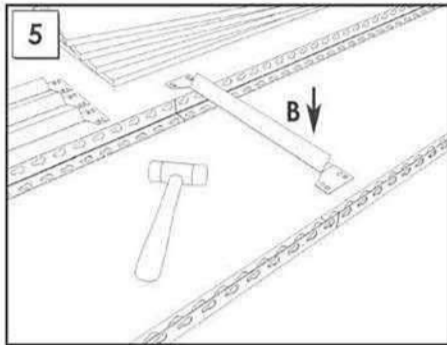
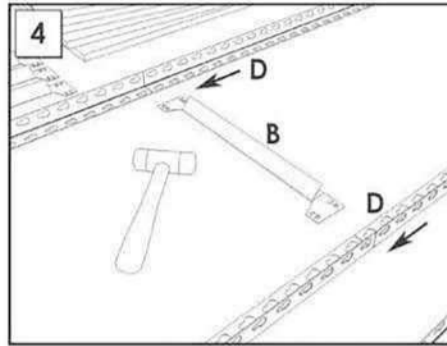
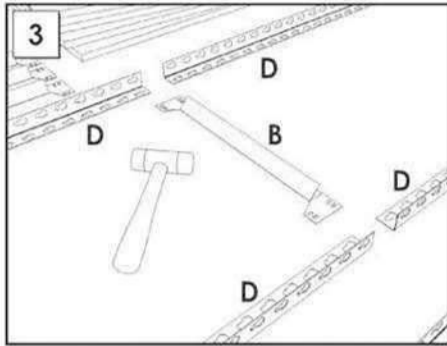
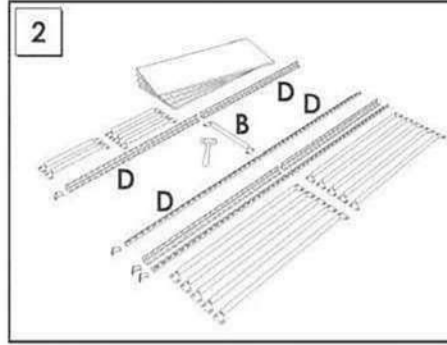
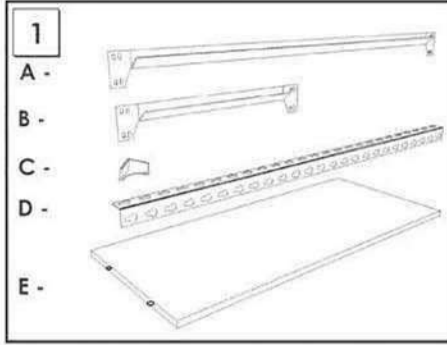

**SIMONCLASSIC**



150 kg  
350 lb

**SIMONCLICK**



400 kg  
900 lb

**SIMONTALLER**



700 kg  
1550 lb

**SIMONAUTO**



300 kg  
660 lb

**SIMONWORK**



800 kg  
1800 lb

**SIMONLOCKER**



**SIMONOFFICE**



275 kg  
600 lb

**SIMONHOME**



150 kg  
330 lb

**SIMONGARDEN**



600 kg  
1330 lb

**SIMONTITÁN**      **SIMONINOX**



900 kg  
1990 lb

**SIMONINDUSTRIAL**

**SIMONPALET**      **SIMONLEVER**



4500 kg  
9950 lb

AL TILLOS Y PASILLOS ELEVADOS  
PLATFORMS AND MEZZANINES  
LAGERBÜHNEN • PLATES-FORMES ET MEZZANINES



www.simonrack.com • www.instructionsrack.com

