

FICHA TÉCNICA
DATA SHEET

SHELBURNE HF

hergom

ESTUFAS DE LEÑA
WOOD STOVES

SHELBURNE HF

MODELO / MODEL	SHELBURNE HF
Potencia Nominal-Máx. (estimada) / Heat Output Nominal-Max. (estimated)	9-13 kW
Rendimiento / Efficiency	79,2 %
Temperatura de humos / Smoke temperature	281 °C
Emisiones CO (13% O2 Vol%) / CO Emissions (13% O2 Vol%)	0,1 %
CERTIFICADO CE / EC CERTIFICATE	RRF- 40 21 5763
NORMATIVA / NORM	EN 13240
Clasificación energética / Energy efficiency Index	
Dimensiones boca del hogar (AnxAl) Firebox opening dimensions (WxH) (mm)	430 x 310
Longitud máxima de troncos / Maximum log length (mm)	470
Salida de humos / Flue exit	Vertical-Trasera / Top-Rear
Ø Salida de humos / Flue exit Ø (mm)	150
Material hogar / Firebox material	Fundición / Cast iron
Control aire primario / Air Wash (cristal limpio) Primary Air control / Air Wash	Si / Si Yes / Yes
Control de aire secundario / Secondary air control	Venturi
Toma de aire exterior / Outside air inlet (Ø 80 mm)	Si / Yes
Peso / Weight (kg)	150

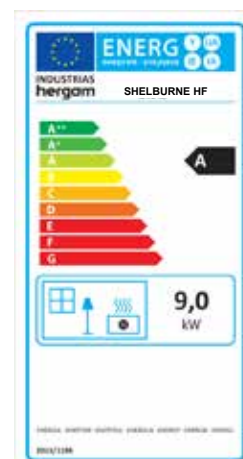



NEGRO MATE
MATTE BLACK



ESMALTE MARRÓN MAYÓLICA
MAJOLICA BROWN ENAMEL



ESMALTE BEIGE PERLA
IVORY ENAMEL

*Acabado interior en HF tratado con fundente blanco para resaltar el efecto de las llamas y ofrecer mayor luminosidad.

Cast iron interior with a white enamel base coat to enhance the flame effect and offer greater luminosity.

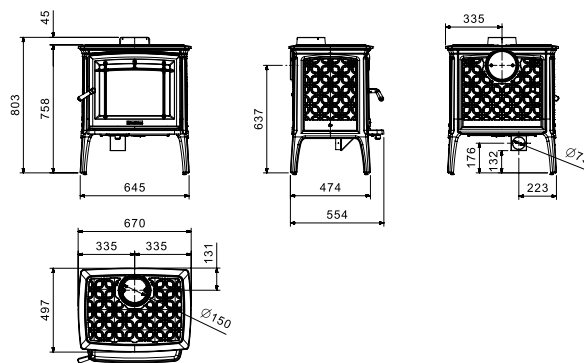

Industrias Hergóm, S.L.
39110 SOTO DE LA MARINA (Cantabria)
Apartado de Correos 208 de Santander
39080 Santander (España)
Tel: +34 942 58 70 00 / Fax: +34 942 58 70 31
comercial@hergom.com

hergom.com

hergom **60** ANI
VER SARIO
1959-2019

Industrias Hergóm, S.L. se reserva el derecho a introducir modificaciones en su gama de productos, sin previo aviso.
La disponibilidad de productos varía según el país.
Las condiciones de garantía y seguro de los productos pueden variar según el país. ©Hergóm 2022

