

Grand Rouge

230V/50Hz | 200 Watt









Experience Better Living



Freestanding

Introducing the Dimplex Grand Rouge, the perfect alternative to gas or wood fireplaces. Designed to suit any room, this exceptional stove boasts our patented Optimyst technology, delivering a truly extraordinary fireplace experience. Prepare to be mesmerized as three-dimensional flames dance before your eyes, creating an incredibly lifelike ambiance. With the added benefit of heating functionality, you can enjoy the complete fireplace experience without the limitations of traditional fuels. The Dimplex Grand Rouge combines innovation and elegance and brings colour to your home.

- Authentic look of cast iron stove
- Decorative glass doors that can be opened
- Metal sheet mirror back panel for a more intensive flame picture
- Rotary thermostat for temperature control

-  One-sided decorative fireplace
-  Surprising by the floating flame and smoke effect and variable flame intensity
-  Enjoy the unique charm of a fireplace 365 days a year using the flames without the heat
-  Optimyst flame technology, flame patterns by cold water vapour
-  Powerful fan-assisted heating by safe element that provides additional heating on demand
-  Control all functions of the fireplace from the comfort of your chair
-  Fireplace can also be operated via button display on the fireplace
-  Easy to connect to a standard socket for instant atmosphere

Grand Rouge

230V/50Hz | 200 Watt

Experience Better Living

Unit Dimensions

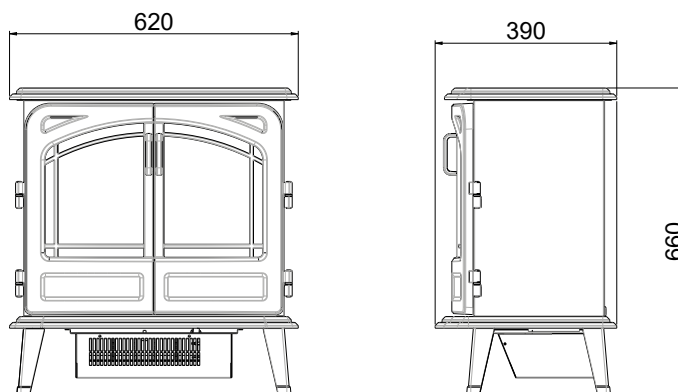

Specifications

Flame Effect system	Optimyst®
Model number	235230F
GTIN/UPC	8716412235238
Model	Freestanding
View Type	Front
Colour - Furniture	Red
Media Bed	Logset
Viewing window WxH (cm)	53x28
Build in dim (WxHxD) (cm)	62x66x39
Heating function	Yes
Heating Element	Yes
Remote Control	Yes
Manual Operation on the fireplace possible	Yes
Lighting Module	Halogen
Sound	No
Media Bed Flame Colours	No
Heat Setting 1 in Watts	1000
Heat Setting 2 in Watts	2000
Power consumption (flame effect) (Watt)	200
Wattage	2000
Voltage	230V/50Hz
Unpacked Weight (kg)	21
Plug Length	1,8 m
Warranty	2 years

