

# C-302 D

Chimenea de Leña de Esquina



## EQUIPAMIENTO

- Sistema de Doble Combustión y Cristal Limpio.
- Medidas Entrada Leña (AxHxF): 545 x 295 x 350 mm.
- Salida Humos Macho Ø 200 mm.
- Cristal Vitrocerámico 750 °C.
- Interior Cámara en Vermiculita.
- Puerta y Rejilla de fundición.
- Doble Cámara.
- Válvula Cortatiros.
- Parrilla de Asados Giratoria 310 x 300 mm.

## CARACTERÍSTICAS TÉCNICAS

**Potencia Térmica Máxima** 13,8 kW.

**Potencia Nominal** 10,9 kW.

**Temperatura de Humos Media** 241 °C.

**Rendimiento** 79 %.

**Combustible** Leña.

**Volumen Calefactable** 295 m<sup>3</sup>.

**Consumo** 3,11 kg/ h.

**CO al 13% O<sub>2</sub>** 0,10 %.

**Partículas al 13% O<sub>2</sub>** 29,58 mg/Nm<sup>3</sup>.

**Equipo elaborado en Acero** Hasta 4 mm.

**Regulación Entrada de Aire** Primario y Secundario

**Pintura Anticalórica** 800°C. Color Negro.

**Tamaño de Tronco** 62 cm.

**Peso** 132 kg.

**Medidas (Ancho x Fondo x Alto)** 829 x 525 x 2400:2900 mm.

**Medidas Frontal (Alto x Ancho)** -

## ACCESORIOS

- Embellecedor a Medida.
- Bote de Spray Pintura Anticalórica 800°C. Color Negro.
- Conjunto Placas de Fundición Cámara de Combustión.
- Manguito Anticondensaciones. Negro Vitrificado.
- Placa de Acero Protector 900 x 705 mm. Color Negro.

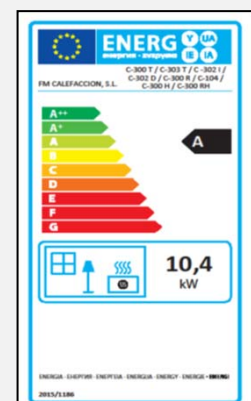

# C-302 D

Versiones



**C-302 D.** Interior Vermiculita.

**C-302 DK.** Interior Vermiculita y Cristal Serigrafiado.

## Ficha Técnica

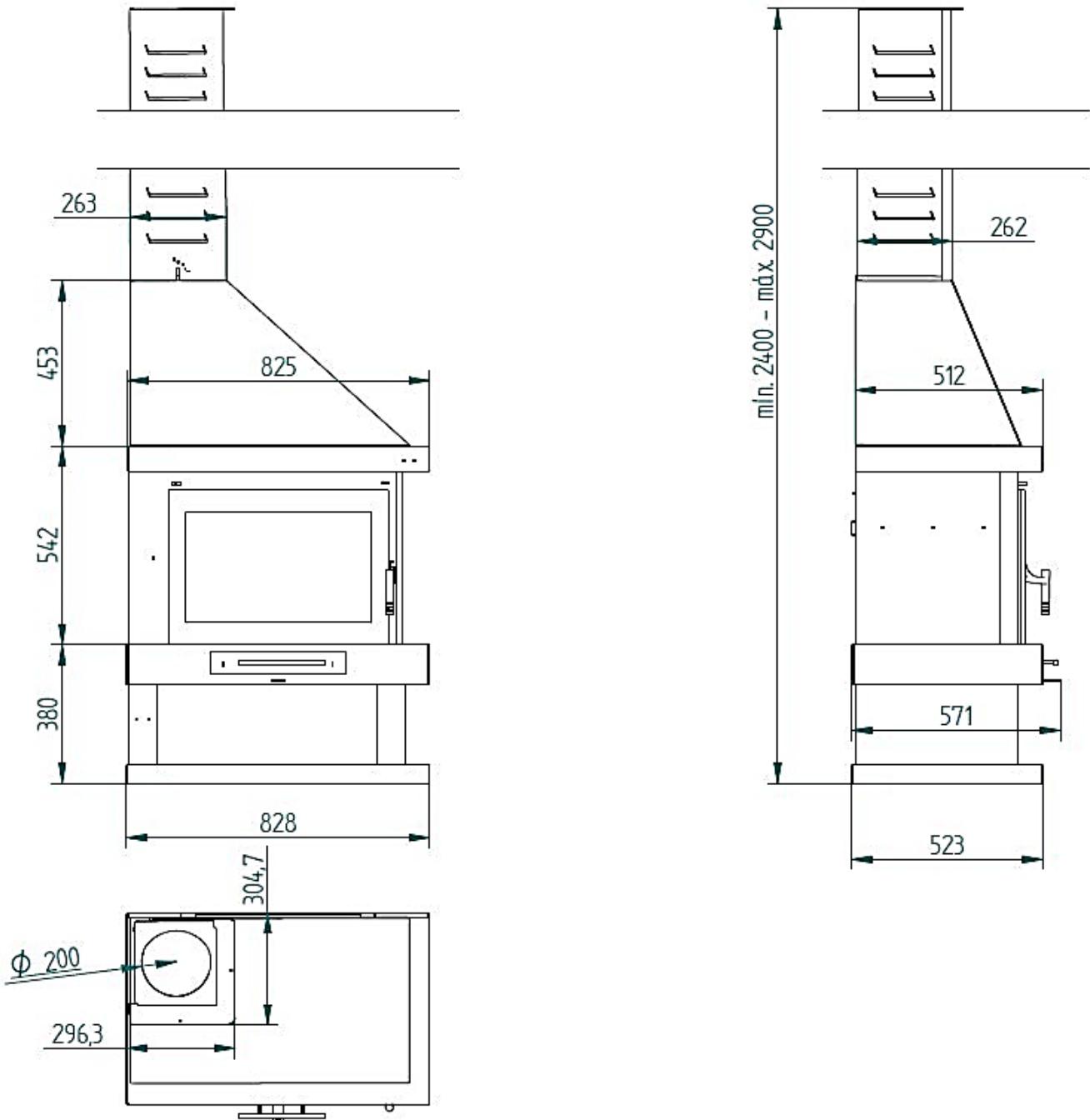

# C-302 I

Chimenea de Leña de Esquina



## EQUIPAMIENTO

- Sistema de Doble Combustión y Cristal Limpio.
- Medidas Entrada Leña (AxHxF): 545 x 295 x 350 mm.
- Salida Humos Macho Ø 200 mm.
- Cristal Vitrocerámico 750 °C.
- Interior Cámara en Vermiculita.
- Puerta y Rejilla de fundición.
- Doble Cámara.
- Válvula Cortatiros.
- Parrilla de Asados Giratoria 310 x 300 mm.

## CARACTERÍSTICAS TÉCNICAS

**Potencia Térmica Máxima** 13,8 kW.

**Potencia Nominal** 10,9 kW.

**Temperatura de Humos Media** 241 °C.

**Rendimiento** 79 %.

**Combustible** Leña.

**Volumen Calefactable** 295 m<sup>3</sup>.

**Consumo** 3,11 kg/ h.

**CO al 13% O<sub>2</sub>** 0,10 %.

**Partículas al 13% O<sub>2</sub>** 29,58 mg/Nm<sup>3</sup>.

**Equipo elaborado en Acero** Hasta 4 mm.

**Regulación Entrada de Aire** Primario y Secundario

**Pintura Anticalórica** 800°C. Color Negro.

**Tamaño de Tronco** 62 cm.

**Peso** 132 kg.

**Medidas (Ancho x Fondo x Alto)** 829 x 525 x 2400:2900 mm.

**Medidas Frontal (Alto x Ancho)** -

## ACCESORIOS

- Embellecedor a Medida.
- Bote de Spray Pintura Anticalórica 800°C. Color Negro.
- Conjunto Placas de Fundición Cámara de Combustión.
- Manguito Anticondensaciones. Negro Vitrificado.
- Placa de Acero Protector 900 x 705 mm. Color Negro.

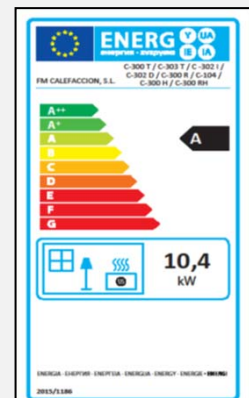

# C-302 I

*Versiones*



**C-302 I.** Interior Vermiculita.

**C-302 IK.** Interior Vermiculita y Cristal Serigrafiado.

## *Ficha Técnica*

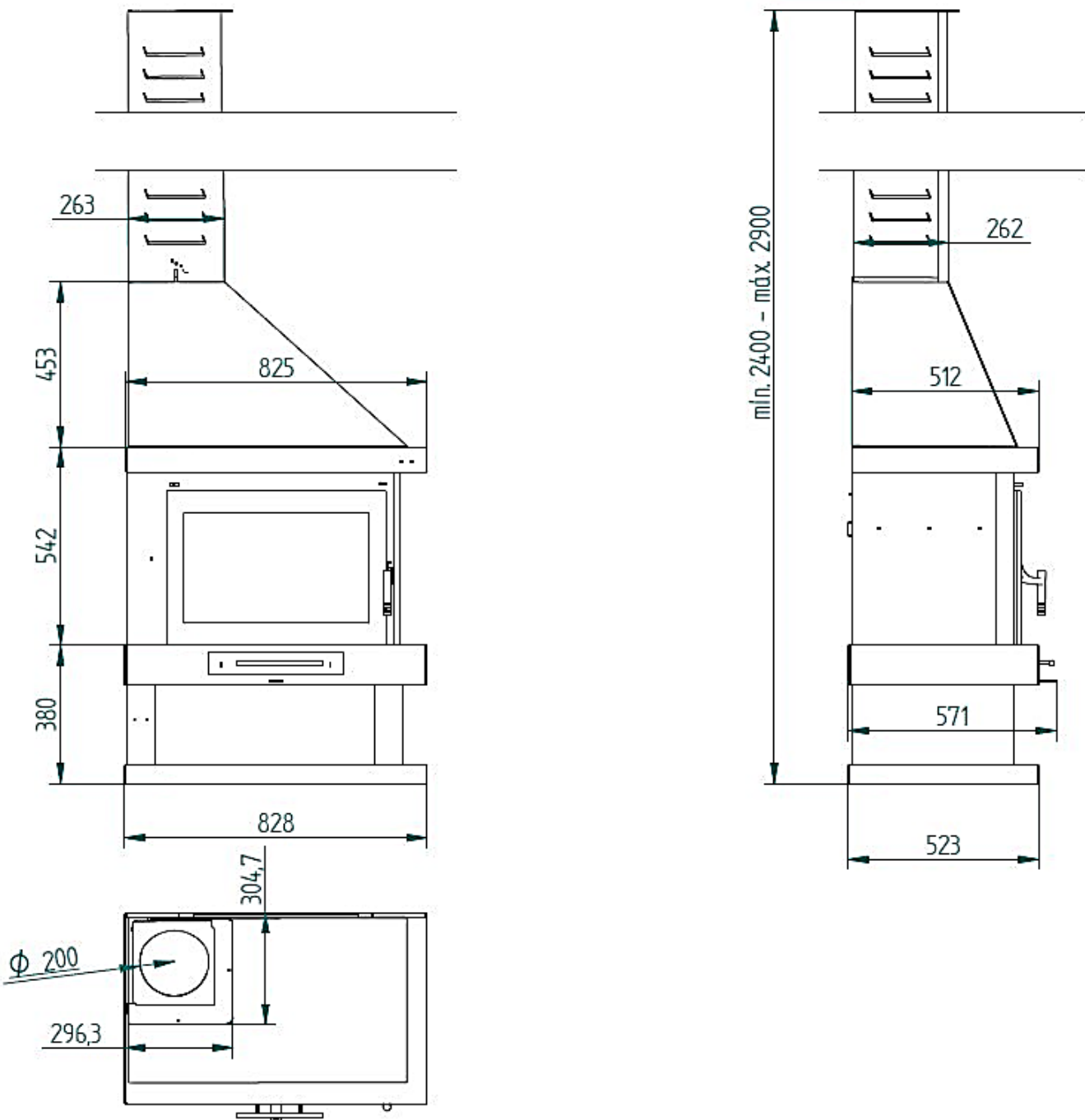

# C-302 D

## Corner Wood Burning Fireplace



### EQUIPMENT

- Double Combustion and Clean Glass System.
- Firewood Measures (WxDxH): 545 x 295 x 350 mm.
- Output Male Fumes Ø 200 mm.
- Glass-ceramic glass 750 °C.
- Interior Camera in Vermiculite.
- Cast iron door and grid.
- Dual Camera.
- Throwshot Shorter Valve.
- Rotating Roast Grill 310 x 300 mm.

### SPECIFICATIONS

**Maximum thermal input** 13,8 kW.

**Rated Power** 10,9 kW.

**Medium Smoke Temperature** 241 °C.

**Yield** 79 %.

**Fuel** Wood.

**Heated Volume** 295 m<sup>3</sup>.

**Consumption** 3,11 kg/ h.

**CO al 13% O<sub>2</sub>** 0,10 %.

**Particulate matter at 13% O<sub>2</sub>** 29,58 mg/Nm<sup>3</sup>.

**Equipment made of Steel** Until 4 mm.

**Primary and Secondary Air Intake Regulation**

**Anticaloric Paint** 800°C. Black Color.

**Trunk Size** 62 cm.

**Weight** 132 kg.

**Measurements (WxDxH)** 829 x 525 x 2400:2900 mm.

**Front Measurements (HxW)** -

### ACCESSORIES

- Custom trim.
- Spray Bottle Anticaloric Paint 800°C. Black Color.
- Set Plates of Casting Combustion Chamber.
- Anti-condensation cuff. Black Vitrified.
- Protective Steel Plate 900 x 705 mm. Black Color.

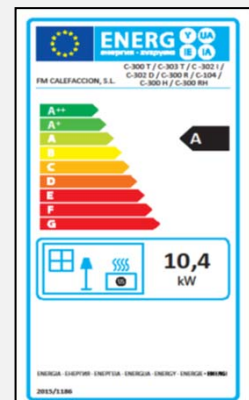

# C-302 D

Versions



**C-302 D.** Vermiculite Interior.

**C-302 DK.** Vermiculite Interior and Silkscreen Glass.

## Data Sheet

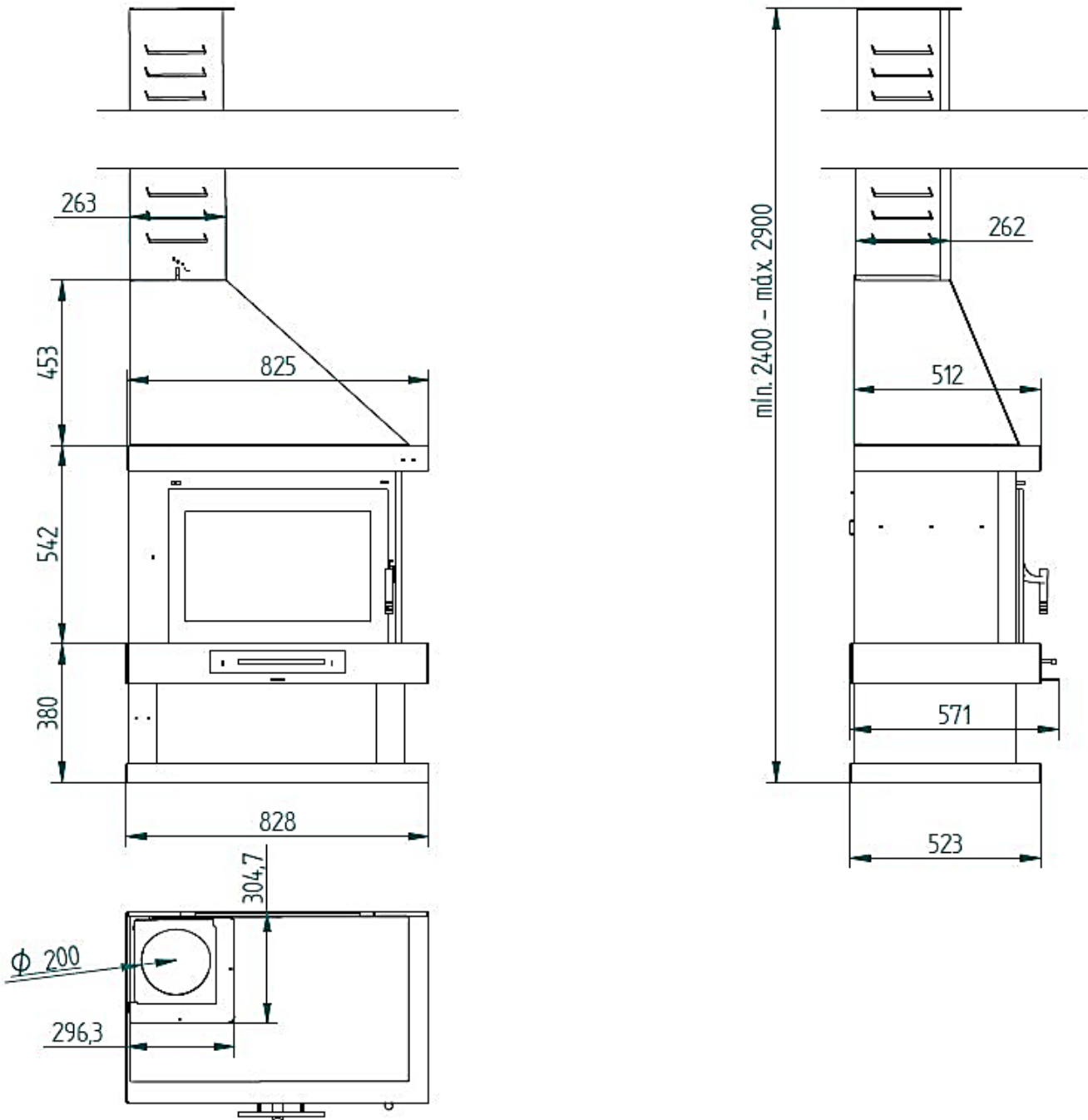

# C-302 I

## Corner Wood Burning Fireplace



### SPECIFICATIONS

**Maximum thermal input** 13,8 kW.

**Rated Power** 10,9 kW.

**Medium Smoke Temperature** 241 °C.

**Yield** 79 %.

**Fuel** Wood.

**Heated Volume** 295 m3.

**Consumption** 3,11 kg/ h.

**CO al 13% O2** 0,10 %.

**Particulate matter at 13% O2** 29,58 mg/Nm3.

**Equipment made of Steel** Until 4 mm.

**Primary and Secondary Air Intake Regulation**

**Anticaloric Paint** 800°C. Black Color.

**Trunk Size** 62 cm.

**Weight** 132 kg.

**Measurements (WxDxH)** 829 x 525 x 2400:2900 mm.

**Front Measurements (HxW)** -

### EQUIPMENT

- Double Combustion and Clean Glass System.
- Firewood Measures (WxDxH): 545 x 295 x 350 mm.
- Output Male Fumes Ø 200 mm.
- Glass-ceramic glass 750 °C.
- Interior Camera in Vermiculite.
- Cast iron door and grid.
- Dual Camera.
- Throwshot Shorter Valve.
- Rotating Roast Grill 310 x 300 mm.

### ACCESSORIES

- Custom trim.
- Spray Bottle Anticaloric Paint 800°C. Black Color.
- Set Plates of Casting Combustion Chamber.
- Anti-condensation cuff. Black Vitrified.
- Protective Steel Plate 900 x 705 mm. Black Color.

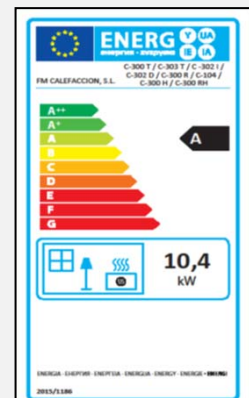

# C-302 I

*Versions*



**C-302 I.** Vermiculite Interior.

**C-302 IK.** Vermiculite Interior and Silkscreen Glass.

## *Data Sheet*

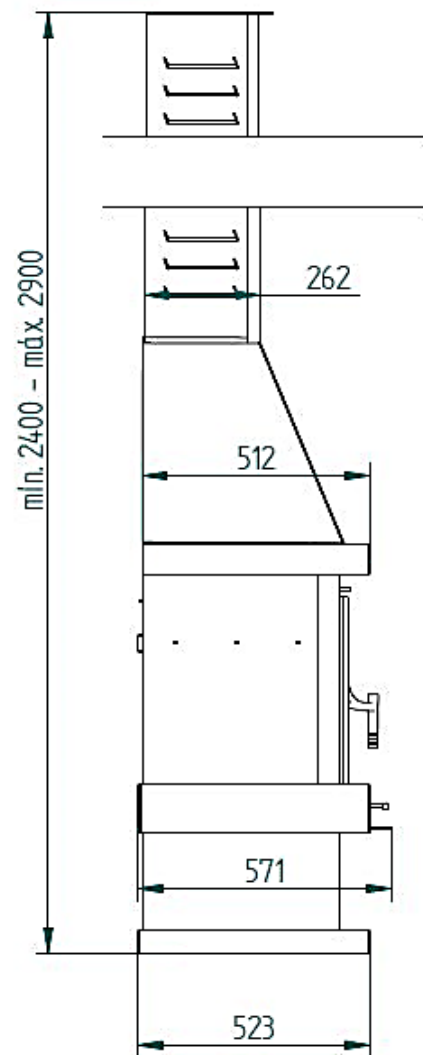
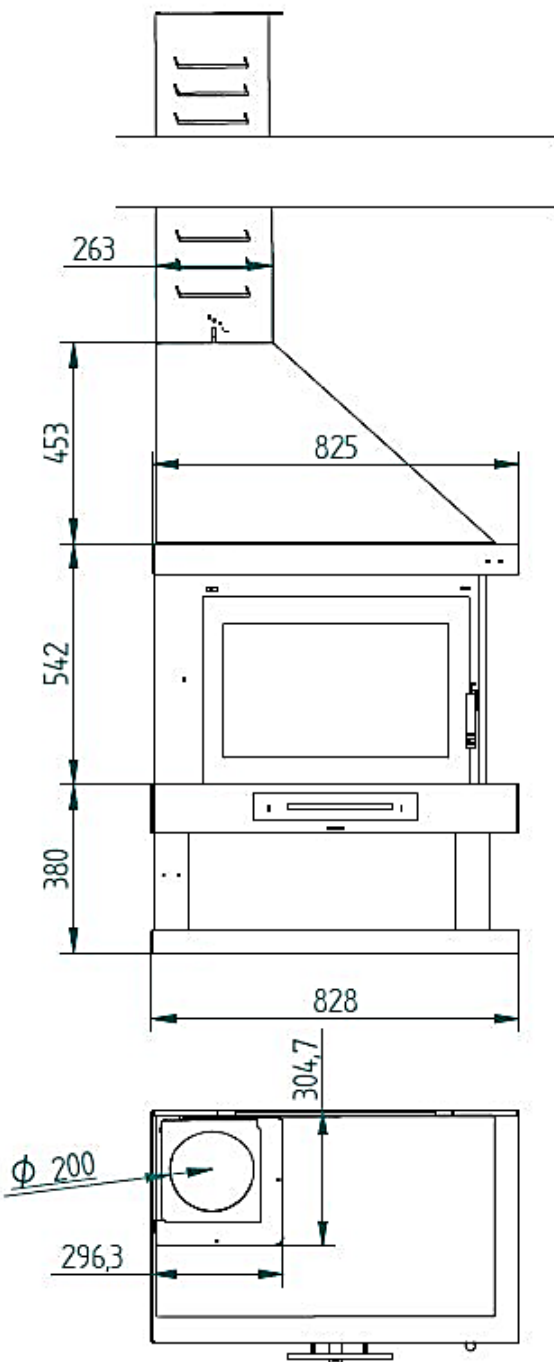



# C-302 D

Coin Foyer au Bois



## ÉQUIPEMENT

- Double combustion et système de verre propre.
- Mesures d'intrants bois (AxHxF): 545 x 295 x 350 mm.
- Sortie de fumées mâle Ø 200 mm.
- Verre vitrocéramique 750 °C.
- Caméra intérieure en vermiculite.
- Porte et grille en fonte.
- Double caméra.
- Valve Throwshot plus courte.
- Grille rotative 310 x 300 mm.

## SPECIFICATIONS

**Puissance thermique maximale** 13,8 kW.

**Puissance nominale** 10,9 kW.

**Température moyenne de fumée** 241 °C.

**Rendement** 79 %.

**Combustible** Bois à brûler.

**Volume chauffé** 295 m<sup>3</sup>.

**Consommation** 3,11 kg/ h.

**CO al 13% O2** 0,10 %.

**Matières particulaires 13 % O2** 29,58 mg/Nm<sup>3</sup>.

**Équipement en acier** Jusqu'à 4 mm.

**Règlement sur les prises d'air primaire et secondaire**

**Peinture anticorrosive** 800°C. Couleur Noir.

**Taille du tronc** 62 cm.

**Poids** 132 kg.

**Mesures (L x P x H)** 829 x 525 x 2400:2900 mm.

**Mesures avant (H x L)** -

## ACCESSOIRES

- Garniture personnalisée.
- Peinture chaude en aérosol 800°C. Couleur Noir.
- Jeu de plaques de coulée pour chambre de combustion.
- Brassard anti-condensation. Noir vitrifié.
- Plaque d'acier de protection 900 x 705 mm. Couleur Noir.

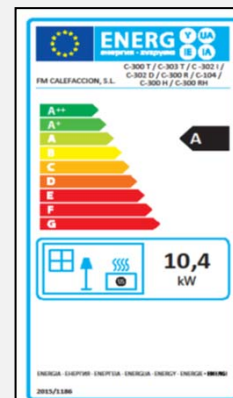

# C-302 D

*Versions*



**C-302 D.** Vermiculite intérieure.

**C-302 DK.** Vermiculite intérieure et Verre Sérigraphié.

## *Fiche technique*

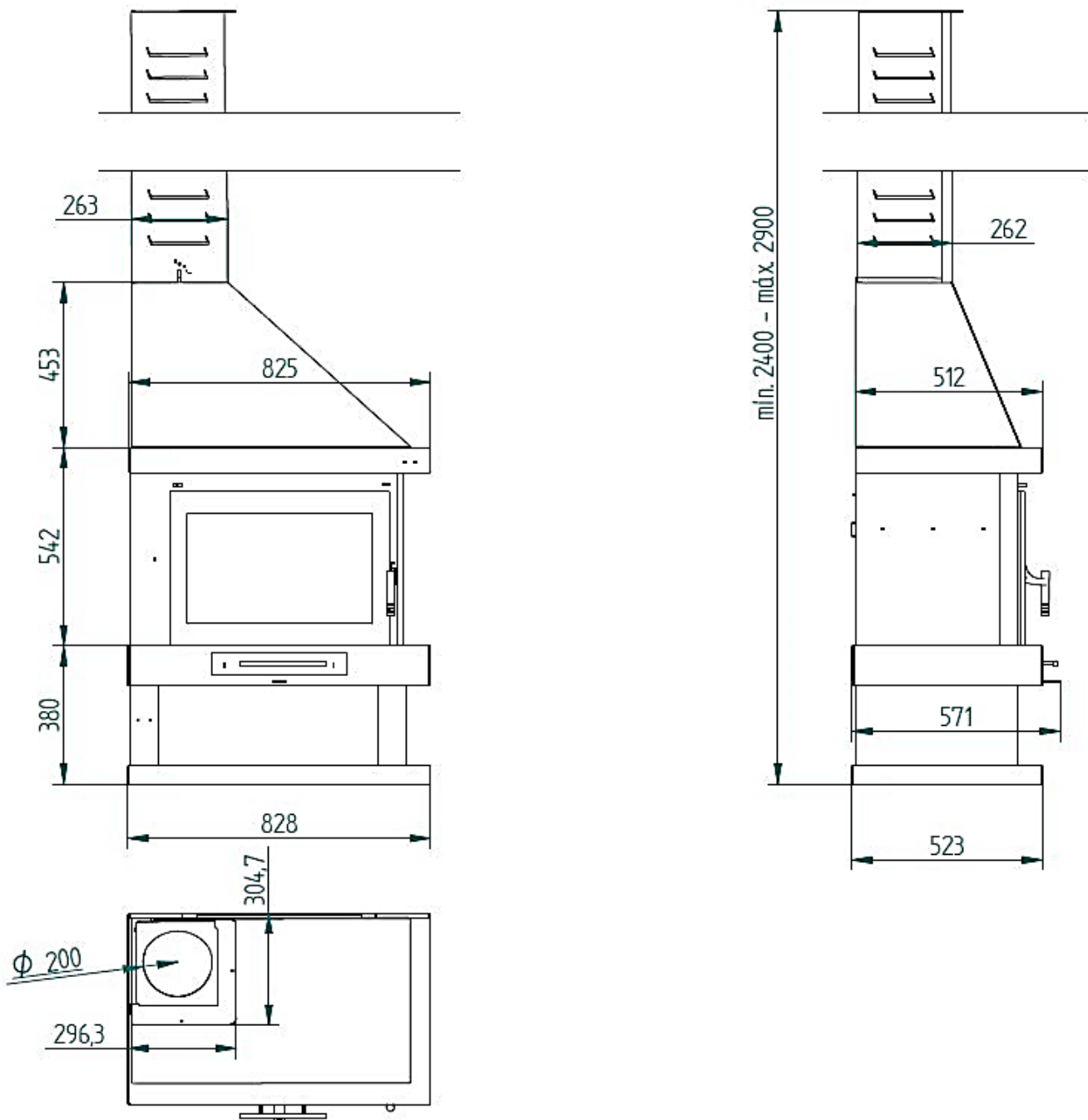

# C-302 I

Coin Foyer au Bois



## SPECIFICATIONS

**Puissance thermique maximale** 13,8 kW.

**Puissance nominale** 10,9 kW.

**Température moyenne de fumée** 241 °C.

**Rendement** 79 %.

**Combustible** Bois à brûler.

**Volume chauffé** 295 m<sup>3</sup>.

**Consommation** 3,11 kg/ h.

**CO al 13% O2** 0,10 %.

**Matières particulaires 13 % O2** 29,58 mg/Nm<sup>3</sup>.

**Équipement en acier** Jusqu'à 4 mm.

**Règlement sur les prises d'air primaire et secondaire**

**Peinture anticorrosive** 800°C. Couleur Noir.

**Taille du tronc** 62 cm.

**Poids** 132 kg.

**Mesures (L x P x H)** 829 x 525 x 2400:2900 mm.

**Mesures avant (H x L)** -

## ÉQUIPEMENT

- Double combustion et système de verre propre.
- Mesures d'intrants bois (AxHxF): 545 x 295 x 350 mm.
- Sortie de fumées mâle Ø 200 mm.
- Verre vitrocéramique 750 °C.
- Caméra intérieure en vermiculite.
- Porte et grille en fonte.
- Double caméra.
- Valve Throwshot plus courte.
- Grille rotative 310 x 300 mm.

## ACCESSOIRES

- Garniture personnalisée.
- Peinture chaude en aérosol 800°C. Couleur Noir.
- Jeu de plaques de coulée pour chambre de combustion.
- Brassard anti-condensation. Noir vitrifié.
- Plaque d'acier de protection 900 x 705 mm. Couleur Noir.

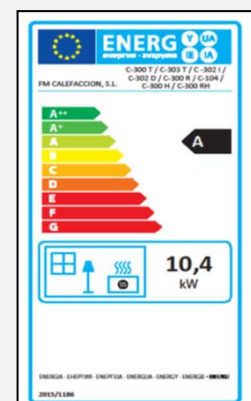

# C-302 I

Versions



**C-302 I.** Vermiculite intérieure.

**C-302 IK.** Vermiculite intérieure et Verre Sérigraphié.

## Fiche technique

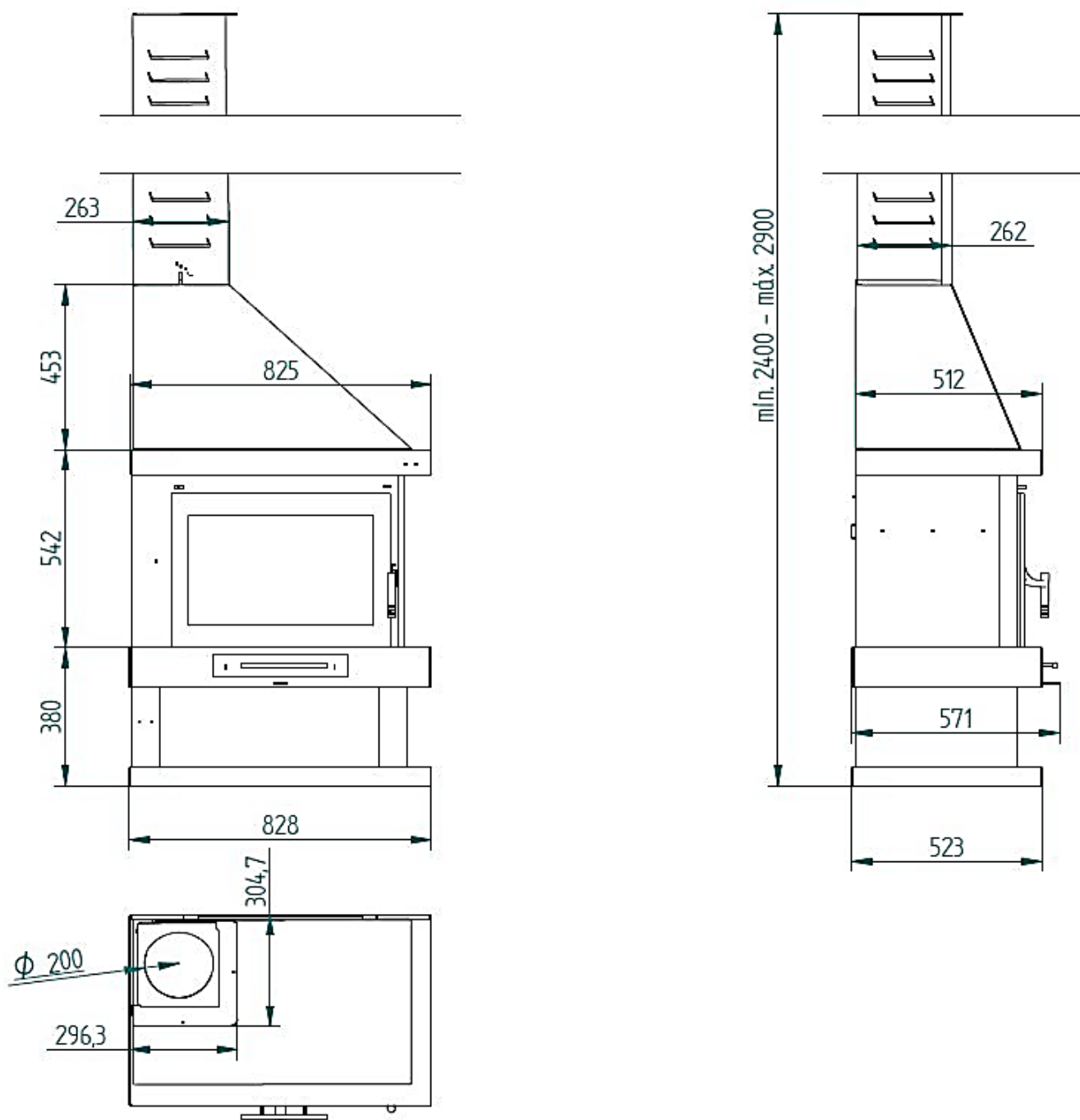

# C-302 D

Lareira a Lenha de Canto



## EQUIPAMENTOS

- Combustão dupla e sistema de vidro limpo.
- Medidas entrada lenha (LxPxA): 545 x 295 x 350 mm.
- Saída fumos machos Ø 200 mm.
- Vidro vitrocerâmico a 750 °C.
- Câmara interior em vermiculita.
- Porta e grade de fundição.
- Câmara dupla.
- Throwshot Válvula mais curta.
- Grelha Assada Rotativa 310 x 300 mm.

## ESPECIFICAÇÕES

**Potência Térmica Máxima** 13,8 kW.

**Potência Nominal** 10,9 kW.

**Temperatura Média de Fumo** 241 °C.

**Rendimento** 79 %.

**Combustível** Lenha.

**Volume Aquecido** 295 m<sup>3</sup>.

**Consumo** 3,11 kg/ h.

**CO 13% O2** 0,10 %.

**Partículas em Suspensão 13% O2** 29,58 mg/Nm<sup>3</sup>.

**Equipamento em Aço** Até 4 mm.

**Regulação da Admissão Ar Primária e Secundária**

**Tinta Anticalórica** 800°C. Cor Preto.

**Tamanho do Tronco** 62 cm.

**Peso** 132 kg.

**Medições (LxPxA)** 829 x 525 x 2400:2900 mm.

**Medições Frontais (AxL)** -

## ACESSÓRIOS

- Acabamento personalizado.
- Frasco de Spray Tinta Anticalórica 800°C. Cor Preto.
- Ajuste placas de câmara de combustão de fundição.
- Punho anti-condensação. Preto Vitrificado.
- Placa de aço protetora 900 x 705 mm. Cor Preto.



# C-302 D

Versões



C-302 D. Interior Vermiculita.

C-302 DK. Interior Vermiculita e Vidro Serigrafado.

Folha

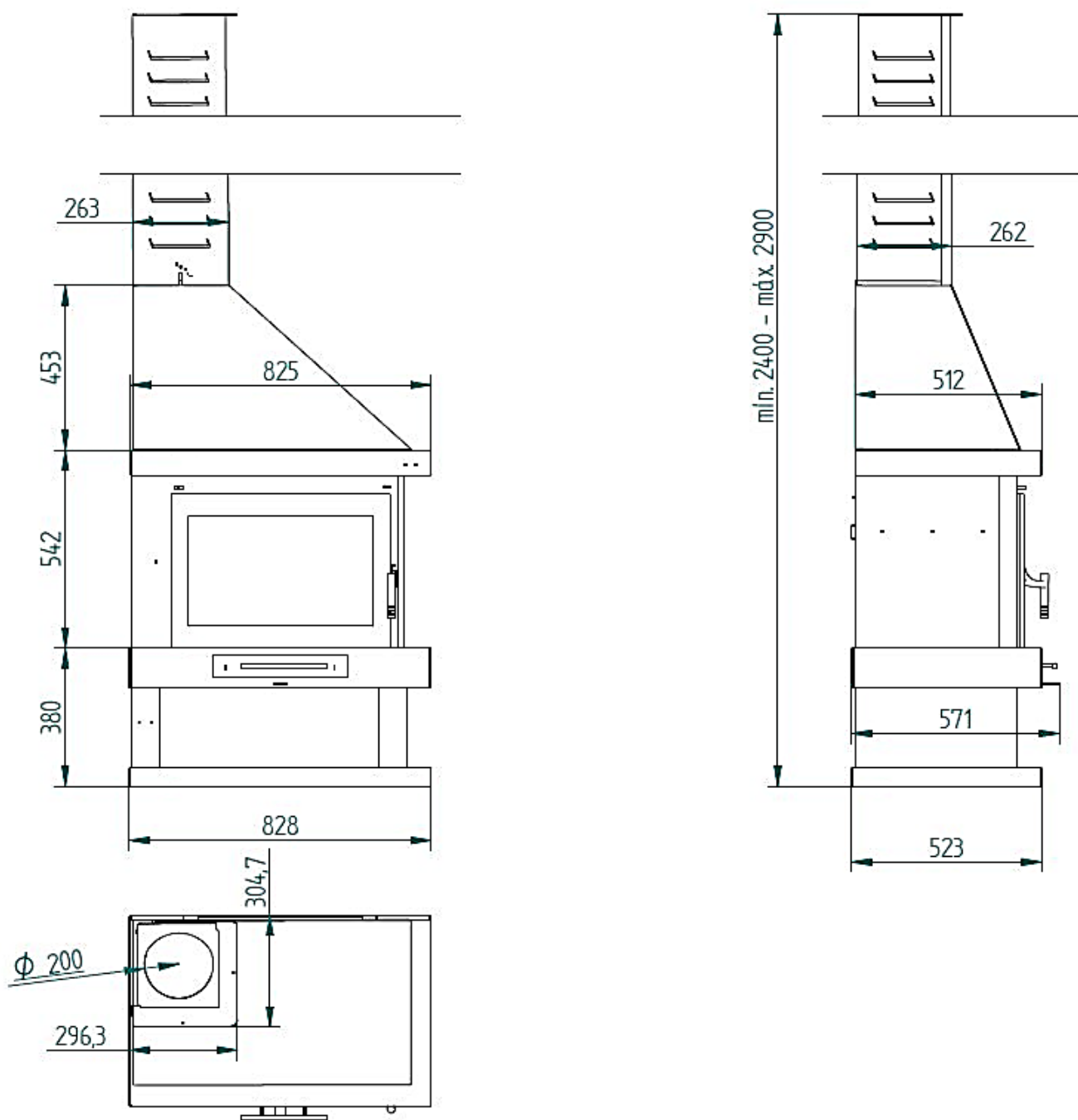

# C-302 I

Lareira a Lenha de Canto



## ESPECIFICAÇÕES

**Potência Térmica Máxima** 13,8 kW.

**Potência Nominal** 10,9 kW.

**Temperatura Média de Fumo** 241 °C.

**Rendimento** 79 %.

**Combustível** Lenha.

**Volume Aquecido** 295 m<sup>3</sup>.

**Consumo** 3,11 kg/ h.

**CO 13% O2** 0,10 %.

**Partículas em Suspensão 13% O2** 29,58 mg/Nm<sup>3</sup>.

**Equipamento em Aço** Até 4 mm.

**Regulação da Admissão Ar Primária e Secundária**

**Tinta Anticalórica** 800°C. Cor Preto.

**Tamanho do Tronco** 62 cm.

**Peso** 132 kg.

**Medições (LxPxA)** 829 x 525 x 2400:2900 mm.

**Medições Frontais (AxL)** -

## EQUIPAMENTOS

- Combustão dupla e sistema de vidro limpo.
- Medidas entrada lenha (LxPxA): 545 x 295 x 350 mm.
- Saída fumos machos Ø 200 mm.
- Vidro vitrocerâmico a 750 °C.
- Câmara interior em vermiculita.
- Porta e grade de fundição.
- Câmara dupla.
- Throwshot Válvula mais curta.
- Grelha Assada Rotativa 310 x 300 mm.

## ACESSÓRIOS

- Acabamento personalizado.
- Frasco de Spray Tinta Anticalórica 800°C. Cor Preto.
- Ajuste placas de câmara de combustão de fundição.
- Punho anti-condensação. Preto Vitrificado.
- Placa de aço protetora 900 x 705 mm. Cor Preto.

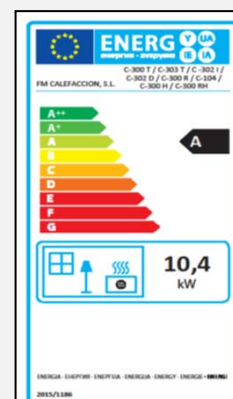

# C-302 I

Versões



C-302 I. Interior Vermiculita.

C-302 IK. Interior Vermiculita e Vidro Serigrafado.

Folha

