

C-200 H

Chimenea de Leña con Horno



EQUIPAMIENTO

- Sistema de Doble Combustión y Cristal Limpio.
- Medidas Entrada Leña (AxHxF): 665 x 370 x 435 mm.
- Salida Humos Macho Ø 250 mm.
- Cristal Vitrocerámico 750 °C.
- Interior Cámara en Vermiculita.
- Puerta y Rejilla de fundición.
- Interior del Horno en Acero Inoxidable.
- Base del Horno en Ladrillo Refractario.
- Termómetro de Vaina.
- Bandeja y Parrilla Inox. 600 x 400 mm.
- Doble Cámara.
- Válvula Cortatiros.
- Parrilla de Asados Giratoria 310 x 300 mm.

CARACTERÍSTICAS TÉCNICAS

Potencia Térmica Máxima 17,5 kW.

Potencia Nominal 13,8 kW.

Temperatura de Humos Media 267 °C.

Rendimiento 79 %.

Combustible Leña.

Volumen Calefactable 373 m3.

Consumo 3,88 kg/h.

CO al 13% O2 0,12 %.

Partículas al 13% O2 33,34 mg/Nm3.

Equipo elaborado en Acero Hasta 4 mm.

Regulación Entrada de Aire Primario y Secundario

Pintura Anticalórica 800°C. Color Negro.

Tamaño de Tronco 75 cm.

Peso 180 kg.

Medidas (Ancho x Fondo x Alto) 950 x 587 x 2590:2900 mm.

Medidas Frontal (Alto x Ancho) -

Medidas Horno (A x F x H) 640 x 400 x 335 mm.

ACCESORIOS

- Embellecedor a Medida.
- Bote de Spray Pintura Anticalórica 800°C. Color Negro.
- Conjunto Placas de Fundición Cámara de Combustión.
- Manguito Anticondensaciones. Negro Vitrificado.
- Placa de Acero Protector 900 x 705 mm. Color Negro.

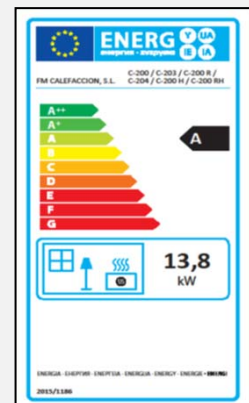

C-200 H

Ficha Técnica

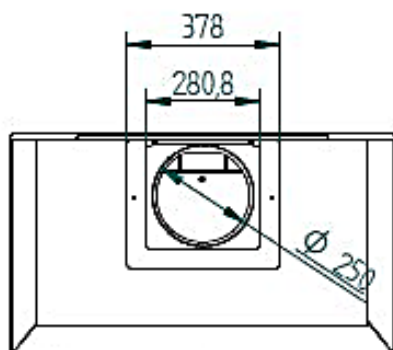
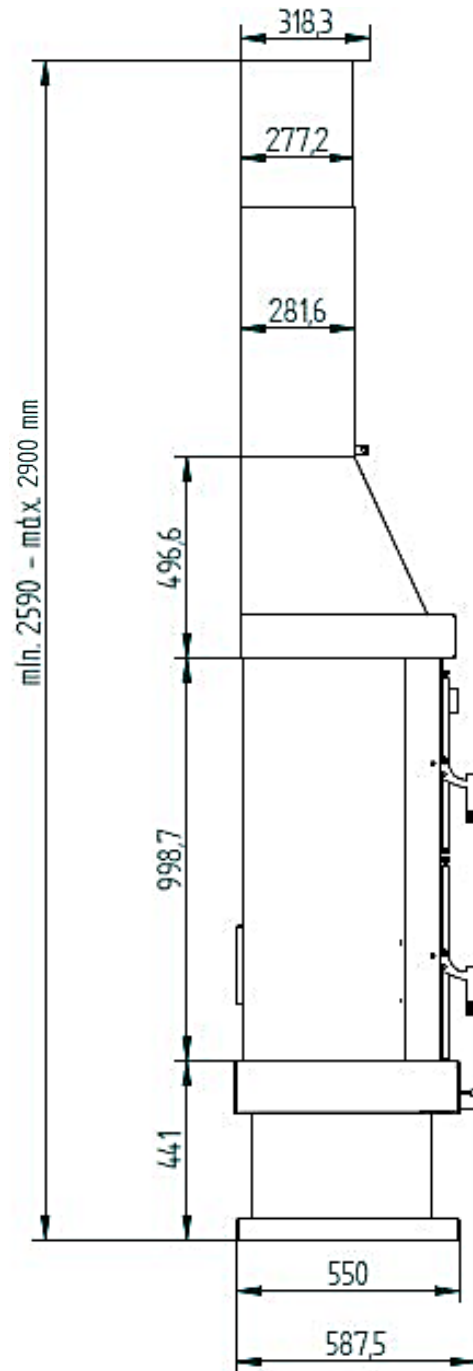
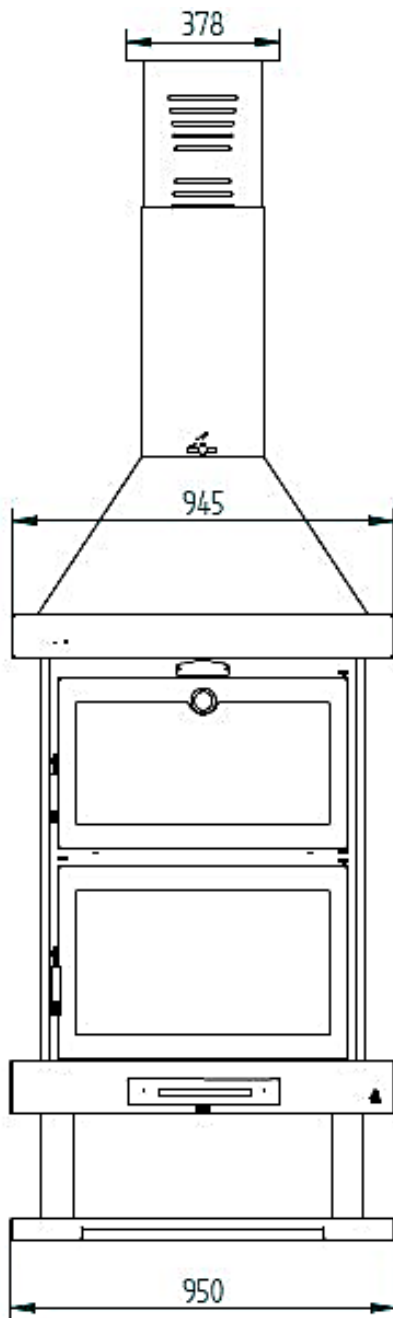

C-200 H

Wood Burning Fireplace with Oven



EQUIPMENT

- Double Combustion and Clean Glass System.
- Firewood Measures (WxDxH): 665 x 370 x 435 mm.
- Output Male Fumes Ø 250 mm.
- Glass-ceramic glass 750 °C.
- Interior Camera in Vermiculite.
- Cast iron door and grid.
- Interior of the Oven in Stainless Steel.
- Base of the Furnace in Refractory Brick.
- Sheath thermometer.
- Tray and Stainless Steel Grill. 600 x 400 mm.
- Dual Camera.
- Throwshot Shorter Valve.
- Rotating Roast Grill 310 x 300 mm.

SPECIFICATIONS

Maximum thermal input 17,5 kW.

Rated Power 13,8 kW.

Medium Smoke Temperature 267 °C.

Yield 79 %.

Fuel Wood.

Heated Volume 373 m3.

Consumption 3,88 kg/h.

CO al 13% O2 0,12 %.

Particulate matter at 13% O2 33,34 mg/Nm3.

Equipment made of Steel Until 4 mm.

Primary and Secondary Air Intake Regulation

Anticaloric Paint 800°C. Black Color.

Trunk Size 75 cm.

Weight 180 kg.

Measurements (WxDxH) 950 x 587 x 2590:2900 mm.

Front Measurements (HxW) -

Oven measures (WxDxH) 640 x 400 x 335 mm.

ACCESSORIES

- Custom trim.
- Spray Bottle Anticaloric Paint 800°C. Black Color.
- Set Plates of Casting Combustion Chamber.
- Anti-condensation cuff. Black Vitrified.
- Protective Steel Plate 900 x 705 mm. Black Color.

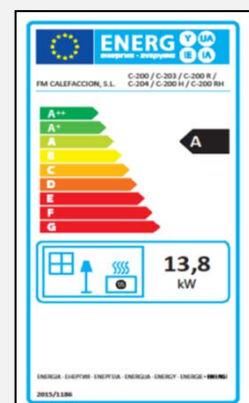

C-200 H

Data Sheet

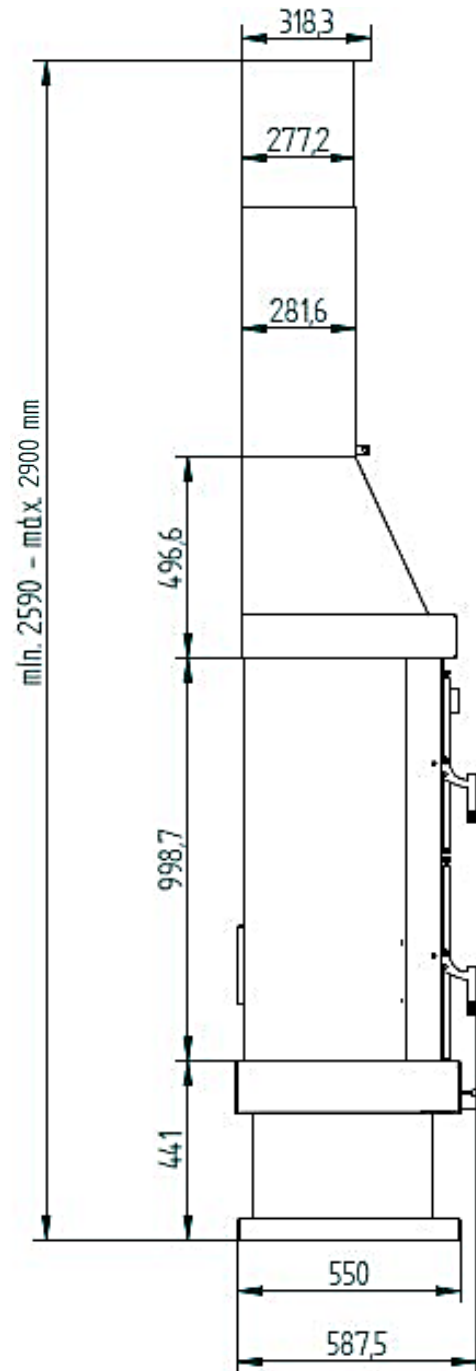
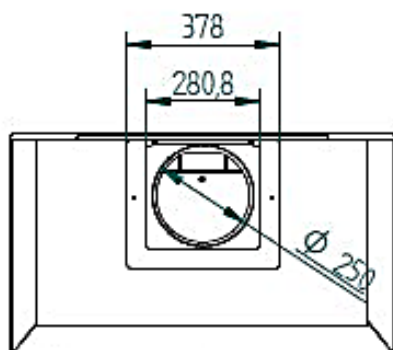
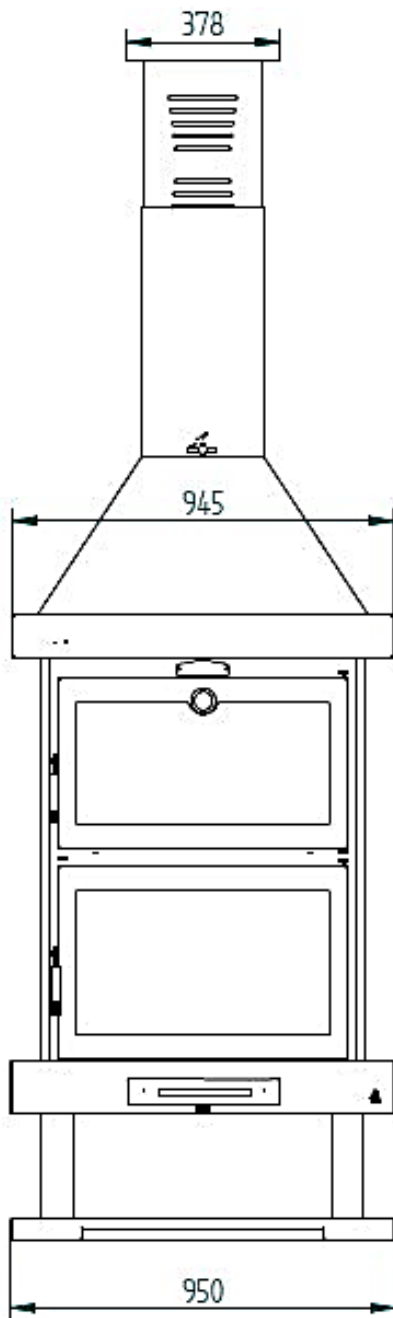

C-200 H

Foyer au Bois avec Four



ÉQUIPEMENT

- Double combustion et système de verre propre.
- Mesures d'intrants bois (AxHxF): 665 x 370 x 435 mm.
- Sortie de fumées mâle Ø 250 mm.
- Verre vitrocéramique 750 °C.
- Caméra intérieure en vermiculite.
- Porte et grille en fonte.
- Intérieur du four en acier inoxydable.
- Base du four en brique réfractaire.
- Thermomètre gaine.
- Plateau et grille en acier inoxydable. 600 x 400 mm.
- Double caméra.
- Valve Throwshot plus courte.
- Grille rotative 310 x 300 mm.

SPECIFICATIONS

Puissance thermique maximale 17,5 kW.

Puissance nominale 13,8 kW.

Température moyenne de fumée 267 °C.

Rendement 79 %.

Combustible Bois à brûler.

Volume chauffé 373 m³.

Consommation 3,88 kg/h.

CO al 13% O2 0,12 %.

Matières particulaires 13 % O2 33,34 mg/Nm³.

Équipement en acier Jusqu'à 4 mm.

Règlement sur les prises d'air primaire et secondaire

Peinture anticorrosive 800°C. Couleur Noir.

Taille du tronc 75 cm.

Poids 180 kg.

Mesures (L x P x H) 950 x 587 x 2590:2900 mm.

Mesures avant (H x L) -

Mesures du four (AxFxH) 640 x 400 x 335 mm.

ACCESSOIRES

- Garniture personnalisée.
- Peinture chaude en aérosol 800°C. Couleur Noir.
- Jeu de plaques de coulée pour chambre de combustion.
- Brassard anti-condensation. Noir vitrifié.
- Plaque d'acier de protection 900 x 705 mm. Couleur Noir.

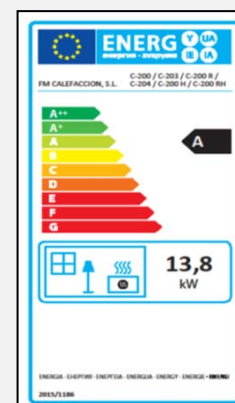

C-200 H

Fiche technique

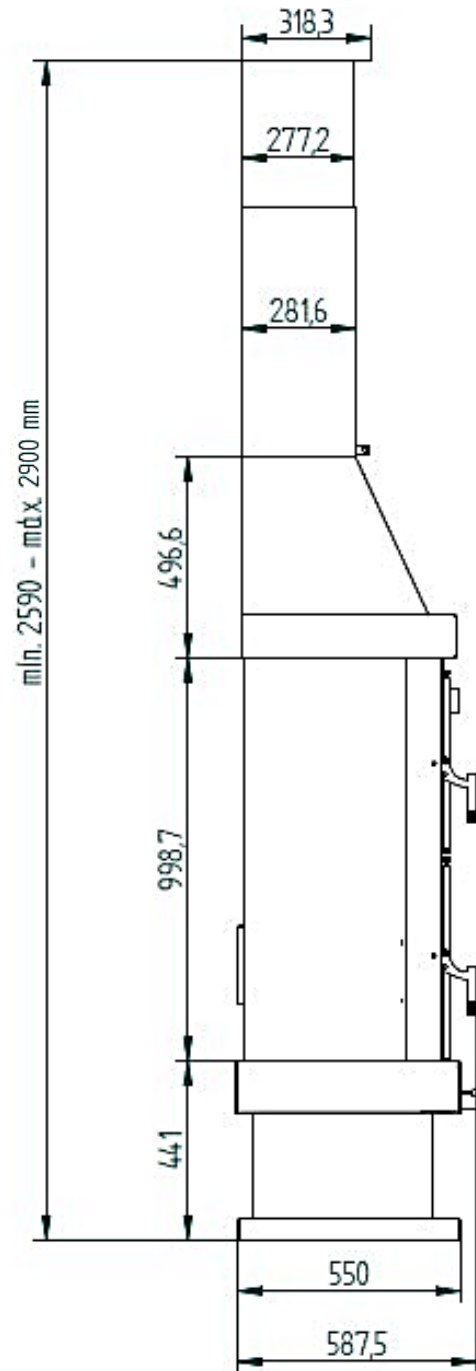
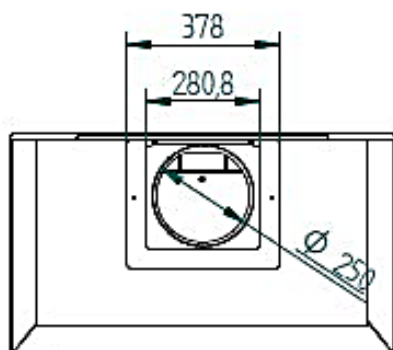
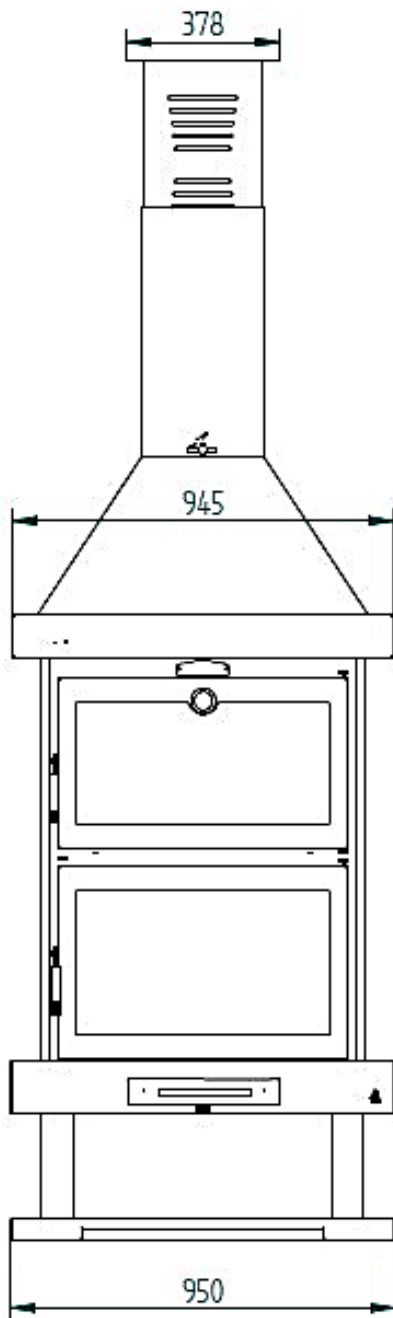

C-200 H

Lareira a Lenha com Forno



EQUIPAMENTOS

- Combustão dupla e sistema de vidro limpo.
- Medidas entrada lenha (LxPxA): 665 x 370 x 435 mm.
- Saída fumos machos Ø 250 mm.
- Vidro vitrocerâmico a 750 °C.
- Câmara interior em vermiculita.
- Porta e grade de fundição.
- Interior do forno em aço inoxidável.
- Base do Forno em Tijolo Refratário.
- Termômetro da bainha.
- Bandeja e grelha em aço inoxidável. 600 x 400 mm.
- Câmara dupla.
- Throwshot Válvula mais curta.
- Grelha Assada Rotativa 310 x 300 mm.

ESPECIFICAÇÕES

Potência Térmica Máxima 17,5 kW.

Potência Nominal 13,8 kW.

Temperatura Média de Fumo 267 °C.

Rendimento 79 %.

Combustível Lenha.

Volume Aquecido 373 m3.

Consumo 3,88 kg/h.

CO 13% O2 0,12 %.

Partículas em Suspensão 13% O2 33,34 mg/Nm3.

Equipamento em Aço Até 4 mm.

Regulação da Admissão Ar Primária e Secundária

Tinta Anticalórica 800°C. Cor Preto.

Tamanho do Tronco 75 cm.

Peso 180 kg.

Medições (LxPxA) 950 x 587 x 2590:2900 mm.

Medições Frontais (AxL) -

Medidas do forno (LxPxA) 640 x 400 x 335 mm.

ACESSÓRIOS

- Acabamento personalizado.
- Frasco de Spray Tinta Anticalórica 800°C. Cor Preto.
- Ajuste placas de câmara de combustão de fundição.
- Punho anti-condensação. Preto Vitrificado.
- Placa de aço protetora 900 x 705 mm. Cor Preto.

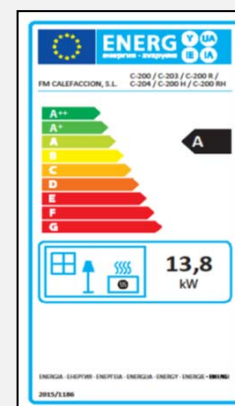

C-200 H

Folha

